Pipeline Associated Watercourse Crossings 4th Edition

November 2012



The Canadian Association of Petroleum Producers (CAPP) is the voice of the upstream oil and natural gas industry in Canada. CAPP represents over 150 member companies who explore for, develop and produce more than 98 per cent of Canada's natural gas, crude oil, oil sands and elemental sulphur.

Our members are part of a \$75-billion-a year industry that affects the lives of every Canadian. Petroleum and the products made from it play a vital role in our daily lives. In addition to providing heating and transportation fuels, oil and natural gas are the main building blocks for an endless list of products - from clothing and carpets, to medicines, glues and paints.

Working closely with our members, governments, communities and stakeholders, CAPP analyzes key oil and gas issues and represents member interests nationally in 12 of Canada's 13 provinces and territories. We also strive to achieve consensus on industry codes of practice and operating guidelines that meet or exceed government standards.

The Canadian Energy Pipeline Association (CEPA) represents Canada's transmission pipeline companies. Our members are world leaders in providing safe, reliable long-distance transportation for over 95% of the oil and natural gas that is produced in Canada. CEPA is dedicated to ensuring a strong and viable transmission pipeline industry in Canada in a manner that emphasizes public safety and pipeline integrity, social and environmental stewardship, and cost competitiveness.

The Canadian Gas Association (CGA) is the voice of Canada's natural gas delivery industry. CGA represents local distribution companies from coast to coast as well as long distance pipeline companies and related manufacturers and other service providers. CGA and its members stand at the junction where Canada's gas delivery system meets the needs of over six million Canadian natural gas customers. CGA's members deliver over 30% of the energy used in Canada.

Disclaimer

This publication was prepared for the Canadian Association of Petroleum Producers (CAPP), Canadian Energy Pipeline Association (CEPA) and Canadian Gas Association (CGA) by TERA Environmental Consultants. While it is believed that the information contained herein is reliable under the conditions and subject to the limitations set out, CAPP, CEPA, CGA and TERA Environmental Consultants do not guarantee its accuracy. This manual recognizes a state of changing regulatory process and as such cautions that the information and references contained herein are of an interim nature until definitive direction is provided by regulators and legislation. The use of this report or any information contained will be at the user's sole risk, regardless of any fault or negligence of TERA Environmental Consultants, CAPP, CEPA or CGA.

Suggested citation:

Canadian Association of Petroleum Producers, Canadian Energy Pipeline Association and Canadian Gas Association. 2012. Pipeline Associated Watercourse Crossings. Prepared by TERA Environmental Consultants. Calgary, AB.

Overview

In 2011, the Canadian Association of Petroleum Producers (CAPP), Canadian Energy Pipeline Association (CEPA) and Canadian Gas Association (CGA) initiated revision of the Third Edition of the *Pipeline Associated Watercourse Crossings* document to incorporate regulatory and technological advancements since the Third Edition was published in 2005. Feedback was solicited from government and industry regarding the Third Edition of *Pipeline Associated Watercourse Crossings*, and those comments were incorporated in this Fourth Edition.

This document outlines the present regulatory framework under which pipeline associated watercourse crossings are assessed and constructed in Canada. In addition, it suggests measures to assist pipeline companies, governing agencies and contractors during the planning, construction, operation and maintenance of pipeline associated watercourse crossings. The development of this document is seen as a means to promote a consistent approach to pipeline associated watercourse crossings throughout Canada and to aid in developing a common understanding among industry, government and other stakeholders.

In April 2012, the federal government tabled Bill C-38, a budget implementation bill that included changes to federal legislation that will impact the regulatory requirements for pipeline associated watercourse crossings. Bill C-38 was passed into law in June 2012 as the *Jobs, Growth and Long-term Prosperity Act*, and included changes to the following federal legislation related to the context of this document: the *Canadian Environmental Assessment Act*; the *National Energy Board Act*; the *Canada Oil and Gas Operations Act*; the *Fisheries Act*; the *Canadian Environmental Protection Act*; and the *Species at Risk Act*. In October 2012, the federal government also tabled Bill C-45 that included changes to the *Fisheries Act* and the *Navigable Waters Protection Act* that will impact the regulatory requirements for pipeline associated watercourse crossings. Bill C-45 was passed into law in December 2012 as the *Jobs and Economic Growth Act*. At the time this Fourth Edition was published, some, but not all, of the legislative amendments resulting from the enactment of Bills C-38 and C-45 were in force; therefore, the Fourth Edition includes only the changes to the above mentioned acts that were in force as of November 2012. This Fourth Edition should be seen as an interim document during the transitional period of these changes. Readers should be aware that changes are expected to regulatory legislation and policy associated with the legislation which will impact the planning, construction, operation and maintenance of pipeline associated watercourse crossings. In addition, there is potential in the future for this document to evolve into a standard operating document that will be a reference document for some federal regulatory requirements.

Acknowledgements

CAPP, CEPA and the CGA would like to acknowledge the contributions made by the following people in the development of the Fourth Edition of Pipeline Associated Watercourse Crossings:

Lonnie King, Fisheries and Oceans Canada, National Headquarters
Neil Fisher, Fisheries and Oceans Canada, National Headquarters
Francis Jackson, Aboriginal Affairs and Northern Development Canada, Northwest Territories Regional Office
Curtis Didham, Environment Canada, Nunavut Regional Office
William Weaver, Manitoba Government
Laureen Janusz, Manitoba Government
Paul Rideout, Newfoundland and Labrador Dept. of Environment and Conservation
Clyde McLean, Newfoundland and Labrador Department of Environment and Conservation
Penny McLeod, Nova Scotia Department of Environment and Labour
Catherine Poirier, New Brunswick Department of Environment
David Maguire, New Brunswick Department of Environment
Jason Hickey, New Brunswick Department of Natural Resources
Jennifer Keyes, Ontario Ministry of Natural Resources
Richard Visser, Ontario Ministry of Natural Resources
Dale Thompson, Prince Edward Island Department of Environment, Labour and Justice
Tom Maher, Saskatchewan Environment
Shannon Jensen, Yukon Department of Environment
Richard Wong, Canadian Association of Petroleum Producers
Thomas Linder, Canadian Energy Pipeline Association
Jim Tweedie, Canadian Gas Association
David McConkey, Canadian Gas Association
Robin Ng, ATCO Gas
Marion Johansen, Spectra Energy Transmission
Colin Rice, Spectra Energy Transmission
Don James, Spectra Energy Transmission
Doug Schmidt, Spectra Energy Transmission
Jim Keil, Manitoba Hydro
Greg Milne, Enbridge Inc.
Jeanette Gasser, Enbridge Inc.
Brad Asmussen, Enbridge Inc.
Edwin Makkinga, Enbridge Inc.
Jennifer Robertson, FortisBC Energy Inc.
Karl Gilmore, TERA Environmental Consultants
Kerry Brewin, TERA Environmental Consultants
Lindsay Watson, TERA Environmental Consultants
Joyce MacNeil, TERA Environmental Consultants
Dave Evans, TERA Environmental Consultants

Glossary

Term	Definition
anadromous	Fish species that travel up freshwater streams to spawn in fresh water, but spend a significant portion of its life in salt water.
bankfull width	The width of a watercourse from ordinary high water mark to ordinary high water mark.
bed and banks	The streambed and the rising slope or face of ground bordering a watercourse, up to the level of rooted terrestrial vegetation.
compensation	The replacement of natural habitat, augmentation in the productivity of existing habitat or maintenance of fish production by artificial means, where mitigation measures are not adequate to maintain habitats for Canada's fisheries resources.
corduroy	Nonsalvageable timber laid on the work side of the right-of-way during nonfrozen conditions to improve passage of traffic through wet areas or muskeg.
cross ditch	A shallow ditch cut into the surface of the right-of-way. Cross ditches run parallel to and are located on the upslope side of diversion berms.
crossing techniques	<p>Open Trenched/Open Cut: The excavation of a trench in flowing or standing water.</p> <p>Isolated: The crossing site is isolated from the main watercourse to prevent construction materials and sediment from entering the watercourse outside of the isolated area.</p> <p>Dam/Pump: A dam is placed in the stream channel to prevent the main flow of water from flowing through the area that will be subjected to disturbance within the stream channel. A pump is used to pump water from the upstream side of the excavation to the downstream side to bypass the instream construction area.</p> <p>Flume: A dam is placed in the stream channel to prevent the main flow of water from flowing through the area that will be subjected to disturbance within the stream channel. A large pipe (flume) is installed to permit the passage of water from the upstream side of the dam to the stream channel downstream of the work area.</p> <p>Trenchless: A crossing method in which there is no disturbance to the bed and banks of a waterbody. Trenchless crossing methods include horizontal bore, horizontal punch and horizontal directional drills (HDD).</p>
diversion berm	An erosion control structure installed on slopes to divert surface water from the right-of-way.
deleterious substance	<p>(a) Any substance that, if added to any water, would degrade or alter or form part of a process of degradation or alteration of the quality of that water so that it is rendered or is likely to be rendered deleterious to fish or fish habitat or to the use by man of fish that frequent that water, or</p> <p>(b) Any water that contains a substance in such quantity or concentration, or that has been so treated, processed or changed, by heat or other means, from a natural state that it would, if added to any other water, degrade or alter or form part of a process of degradation or alteration of the quality of that water so that it is rendered or is likely to be rendered deleterious to fish or fish habitat or to the use by man of fish that frequent that water.</p>
deposit	Means any discharging, spraying, releasing, spilling, leaking, seeping, pouring, emitting, emptying, throwing, dumping or placing.
fish	Includes: parts of fish; shellfish, crustaceans, marine animals and any parts of shellfish, crustaceans or marine animals; and, the eggs, sperm, spawn, larvae, spat and juvenile stages of fish, shellfish, crustaceans and marine animals.
fish habitat	Spawning grounds and nursery, rearing, food supply and migration areas on which fish depend directly or indirectly in order to carry out their life processes.

Glossary cont'd

Term	Definition
fishery	Includes the area, locality, place or station in or on which a pound, seine, net, weir or other fishing appliance is used, set, placed or located, and the area, tract or stretch of water in or from which fish may be taken by the said pound, seine, net, weir or other fishing appliance, and also the pound, seine, net, weir, or other fishing appliance used in connection therewith.
frac-out	The inadvertent seepage of drilling mud onto the ground or into surface waters through fractures in the subsurface. Frac-outs can occur when using pressurized crossing construction methods such as horizontal directional drilling.
freshet	Rapid temporary rise in stream discharge and water level, caused by heavy rains or rapid melting of snow and ice.
grubbing	A construction activity that involves removing tree roots and stumps and associated surface soil from the pipeline right-of-way or other areas that will be under development.
HADD	<p>Harmful alteration, disruption or destruction (HADD) of fish habitat is defined by Fisheries and Oceans Canada (DFO) as "any change in fish habitat that reduces its capacity to support one or more life processes of fish".</p> <p>It should be noted that this definition of HADD applies when determining if, or whether, any of the three conditions (<i>i.e.</i>, harmful alteration, disruption, or destruction) identified in Subsection 35(1) of the <i>Fisheries Act</i>, are likely to result from a project. These conditions do differ, and are differentiated essentially by the severity of impacts and their duration, as follows:</p> <p>harmful alteration - any change to fish habitat that indefinitely reduces its capacity to support one or more life processes of fish, but does not completely eliminate the habitat;</p> <p>disruption - any change to fish habitat occurring for a limited period which reduces its capacity to support one or more life processes of fish; and</p> <p>destruction - any permanent change of fish habitat which completely eliminates its capacity to support one or more life processes of fish.</p>
instream activity	Usually interpreted as any activity conducted in a waterbody (<i>i.e.</i> , stream, river, lake, pond, isolated pool).
mitigation	Actions taken during the planning, design, construction and operation of works and undertakings to alleviate potential adverse effects on the productive capacity of fish habitats.
navigable waterway	A navigable water is defined by the <i>Navigable Waters Protection Act</i> as being "any body of water capable, in its natural state, of being navigated by floating vessels of any description for the purpose of transportation, recreation or commerce, and may also be a man-made feature such as a canal or reservoir".
net gain	An increase in the productive capacity of habitats for selected fisheries brought about by determined government and public efforts to conserve, restore and develop habitats.
no net loss	A working principle by which DFO strives to balance unavoidable habitat losses with habitat replacement on a project-by-project basis so that further reductions to Canada's fisheries resources due to habitat loss or damage may be prevented.
obstruction	Means any slide, dam or other obstruction impeding the free passage of fish.
ordinary high water mark	The visible high water mark of any lake, stream, or other body of water where the presence and action of the water are so common and usual and so long continued in all ordinary years as to mark upon the soil of the bed of the lake, river stream, or other body of water a character distinct from that of the banks, both in vegetation and in the nature of the soil itself. Typical features may include a natural line or 'mark' impressed on the bank or shore, indicated by erosion, shelving, changes in soil characteristics, destruction of terrestrial vegetation, or other distinctive physical characteristics.

Glossary cont'd

periphyton	Matrix of algae and microbes attached to submerged strata in aquatic ecosystems.
productive capacity	The maximum natural capability of habitats to produce healthy fish, safe for human consumption, or to support or produce aquatic organisms upon which fish depend.
restoration (of habitat)	The treatment or clean-up of fish habitat that has been altered, disrupted or degraded for the purpose of increasing its capability to sustain a productive fisheries resource.
riparian	Pertaining to anything connected with, or immediately adjacent to, the banks of a watercourse or waterbody.
riprap	A foundation or revetment made of irregularly placed stones or pieces of boulder on earth surfaces (e.g. stream banks) to reduce erosion of underlying soil or material by water.
shoo-fly	Temporary access road generally used near watercourse crossings with steep valley slopes, to allow vehicles to traverse the slopes on a gentler grade.
subdrain	Subsurface drain that is installed at trench depth, or slightly deeper, that is designed to move groundwater away from the trench line and drain the water off the right-of-way.
thalweg	A line parallel to the direction of flow that defines the deepest and fastest portion of a stream channel.
total suspended solids (TSS)	A measure of the total concentration of suspended solids, (i.e. material such as silt, clay, organic matter and microscopic organisms) that is suspended or carried in the water column and not in contact with the bottom substrate in water.
trench breaker	An erosion control device consisting of impermeable material that is placed within the trench after the pipe has been lowered in and before backfilling. Trench breakers are designed to block the water movement along the trench line and direct it to the surface where it is directed away from the trench line.
trench plug	A small portion of the trench line that is left unexcavated (hard plug) or is filled in after excavation (soft plug), to block water flow along the trench or allow wildlife to cross the trench at known and used wildlife trails.

List of Acronyms

Acronym	Definition
AENV	Alberta Environment
AEP	Alberta Environmental Protection
AESRD	Alberta Environment and Sustainable Resource Development
AANDC	Aboriginal Affairs and Northern Development Canada
ASRD	Alberta Sustainable Resource Development
BC	British Columbia
C&R	Conservation and Reclamation
CAPP	Canadian Association of Petroleum Producers
CCME	Canadian Council of Ministers of the Environment
CEAA	<i>Canadian Environmental Assessment Act</i>
CEPA	Canadian Energy Pipeline Association
CGA	Canadian Gas Association
COSEWIC	Committee on the Status of Endangered Wildlife in Canada
DAP	Development Assessment Process (Yukon)
DFO	Fisheries and Oceans Canada
EAP	Enhanced Approval Process
EFR	Environmental Field Report
ESA	Environmental and Socio-economic Assessment
GPR	ground penetrating radar
HADD	harmful alteration, disruption or destruction [of fish habitat]
HCDF	Habitat Compliance Decision Framework
HCM	Habitat Compliance Modernization
HDD	horizontal directional drill
ILA	Inuvialuit Land Administration
INAC	Indian and Northern Affairs Canada
IOL	Inuit owned lands
ISR	Inuvialuit Settlement Region
MFO	Minister of Fisheries and Oceans (Federal)
MOE	British Columbia Ministry of Environment
MOF	British Columbia Ministry of Forests
MFLNRO	British Columbia Ministry of Forests, Lands and Natural Resource Operations
MVLWB	Mackenzie Valley Land and Water Board
MWLAP	British Columbia Ministry of Water, Land and Air Protection
NEB	National Energy Board
NIRB	Nunavut Impact Review Board
NPC	Nunavut Planning Commission
NSA	Nunavut Settlement Area
NTU	nephelometric turbidity units
NWB	Nunavut Water Board
NWT	Northwest Territories
NWPA	<i>Navigable Waters Protection Act</i>
NWPP	Navigable Waters Protection Program
OGC	British Columbia Oil and Gas Commission
OMOE	Ontario Ministry of Environment
OMNR	Ontario Ministry of Natural Resources
OS	Operational Statement
PASC	Pipeline Abandonment Steering Committee
PEI	Prince Edward Island

List of Acronyms cont'd

Acronym	Definition
PLA	pipeline agreement
POE	pathway of effect
RIC	Resources Inventory Committee
RMF	risk management framework
SARA	<i>Species at Risk Act</i>
TC	Transport Canada
TSS	total suspended solids
YESAA	<i>Yukon Environmental and Socioeconomic Assessment Act</i>
YESAB	Yukon Environmental and Socioeconomic Assessment Board

Contents

1	Introduction.....	1-1
1.1	Updates to Document.....	1-1
1.2	Environmental Effects of Pipeline Watercourse Crossings	1-3
1.2.1	Effects on Aquatic Habitat.....	1-3
1.2.2	Effects on Fish Populations	1-4
1.2.3	Additional Consequences of Watercourse Crossings	1-5
1.2.4	Natural Watercourse Dynamics	1-6
1.3	Objectives for Watercourse Crossings.....	1-7
2	Regulatory and Information Requirements.....	2-1
2.1	Federal Jurisdictions	2-1
2.1.1	<i>Fisheries Act</i>	2-5
2.1.2	<i>Navigable Waters Protection Act</i>	2-10
2.1.3	<i>National Energy Board Act</i>	2-12
2.1.4	<i>Canadian Environmental Assessment Act, 2012</i>	2-14
2.1.5	<i>Indian Oil and Gas Act</i>	2-15
2.1.6	<i>Canada Oil and Gas Operations Act</i>	2-16
2.1.7	<i>Species at Risk Act</i>	2-16
2.1.8	<i>Migratory Birds Convention Act</i>	2-16
2.1.9	<i>Constitution Act, 1982</i>	2-17
2.2	Provincial and Territorial Jurisdictions.....	2-17
2.2.1	Alberta.....	2-18
2.2.2	British Columbia.....	2-21
2.2.3	Manitoba	2-23
2.2.4	New Brunswick.....	2-25
2.2.5	Newfoundland and Labrador	2-25
2.2.6	Northwest Territories	2-26
2.2.7	Nova Scotia.....	2-27
2.2.8	Nunavut.....	2-28
2.2.9	Ontario	2-29
2.2.10	Prince Edward Island	2-30
2.2.11	Québec	2-31
2.2.12	Saskatchewan	2-32
2.2.13	Yukon.....	2-33
3	Description of Crossing Techniques.....	3-1
3.1	Pipeline Crossings.....	3-1
3.2	Temporary Vehicle Crossings.....	3-1
4	Risk-Based Watercourse Crossing Selection Process.....	4-1
4.1	DFO Risk Management Framework.....	4-1
4.1.1	Elements of a Risk Management Program.....	4-2
4.1.2	Process for Assessing Risk to Fish Habitat.....	4-2

4.2	Crossing Assessment	4-9
4.2.1	Aquatic Assessment	4-9
4.2.2	Geotechnical and Hydraulic Assessment.....	4-13
4.2.3	Cumulative Effects.....	4-14
4.3	Environmental Selection Considerations	4-16
4.3.1	Regulatory Risk	4-16
4.3.2	Habitat Compliance Decision Framework.....	4-17
4.3.3	Construction Risk.....	4-21
4.3.4	Post-Construction Risk	4-21
4.4	Economic Selection Considerations	4-26
4.4.1	Direct Costs.....	4-26
4.4.2	Indirect Costs	4-26
4.5	Crossing Method Selection.....	4-29
4.5.1	Pipeline Crossings.....	4-29
4.5.2	Vehicle Crossings	4-32
5	Environmental Mitigation Procedures	5-1
5.1	Planning and Design	5-1
5.2	Crossing Construction.....	5-2
5.2.1	General Mitigation Procedures	5-2
5.2.2	Surveying	5-5
5.2.3	Clearing.....	5-5
5.2.4	Topsoil Handling	5-6
5.2.5	Grading	5-7
5.2.6	Welding and Weighting.....	5-8
5.2.7	Instream Blasting	5-8
5.2.8	Isolated Crossing Methods.....	5-9
5.2.9	Pipe Installation	5-10
5.2.10	Instream Sediment Control	5-11
5.2.11	Subsurface Drainage Control.....	5-12
5.2.12	Backfilling.....	5-13
5.2.13	Surface Erosion and Sediment Control.....	5-13
5.2.14	Clean-up and Reclamation.....	5-14
5.2.15	Temporary Vehicle Crossings.....	5-15
5.2.16	Abandonment.....	5-15
6	Habitat Mitigation and Compensation.....	6-1
6.1	Compensation	6-1
6.1.1	Compensation Plans.....	6-2
6.1.2	Habitat Compensation Options.....	6-3
6.1.3	Determining the Amount of Compensation Required	6-5
6.1.4	Compliance and Effectiveness Monitoring of Compensation	6-5
6.2	Mitigation and Compensation Techniques	6-6
6.2.1	Bank and Riparian Habitat Restoration and Enhancement.....	6-7
6.2.2	Instream Habitat Restoration and Enhancement.....	6-8

7	Monitoring Crossing Project Performance	7-1
7.1	Environmental Monitoring During Construction.....	7-2
7.1.1	Environmental Inspection	7-2
7.1.2	Suspended Sediment Load.....	7-3
7.1.3	Substrate Composition.....	7-5
7.1.4	Biological Monitoring.....	7-6
7.1.5	Additional Monitoring for Horizontal Directional Drills	7-7
7.1.6	Monitoring During Blasting and Diversions.....	7-8
7.2	Post-Construction Monitoring	7-8
8	References.....	8-1

Appendices

Appendix A	Typical Watercourse Crossing Drawings
Appendix B	Watercourse Crossing Case History Summaries

Figures

Figure 4.1	Planning Summary for Watercourse Crossings	4-6
Figure 4.2	DFO Risk Assessment Matrix	4-7
Figure 4.3	Process for Assessing Risk to Fish Habitat.....	4-8
Figure 4.4	Process Map for the Application of the Habitat Compliance Decision Framework	4-19
Figure 4.5	Compliance Risk Assessment Matrix.....	4-20

Tables

Table 2.1	Regulatory and Information Contacts	2-2
Table 2.2	Fisheries and Oceans Canada’s Operational Statements Applicable to Pipeline Associated Watercourse Crossings Across Canada as of May 15, 2012	2-8
Table 3.1	Pipeline Watercourse Crossing Construction Techniques	3-2
Table 3.2	Vehicle Watercourse Crossing Techniques.....	3-14
Table 4.1	Environmental and Engineering Considerations for Pipeline Crossing Selection .	4-10
Table 4.2	Detailed Aquatic Assessment Evaluation Parameters.....	4-11
Table 4.3	Cumulative Effects Analysis Tools for Watercourse Crossings	4-15
Table 4.4	Risk Considerations for Watercourse Crossing Methods.....	4-22
Table 4.5	Relative Costs ^{1,2} of Watercourse Crossing Techniques	4-27
Table 4.6	Economic Considerations of Watercourse Crossing Methods	4-28
Table 4.7	Pipeline Crossing Construction Technique Selection Considerations	4-31
Table 4.8	Vehicle Crossing Technique Selection Considerations.....	4-33
Table 5.1	Erosion Control Techniques.....	5-17
Table 6.1	Bank Restoration and Enhancement.....	6-10
Table 6.2	Instream Habitat Restoration and Enhancement Techniques.....	6-13

1 Introduction

Watercourse crossings are a unique component of pipeline construction projects. Watercourse crossing construction typically requires devoted crews and specialized equipment, specific engineering design and specific planning and regulatory considerations. Watercourse crossings pose unique risks to the success of pipeline projects, and ultimately to the contractors that construct them.

The regulatory requirements for the approval and construction of pipeline associated watercourse crossings in Canada vary according to the jurisdiction in which the project is being built and the environmental setting within which the project is planned. The Canadian Association of Petroleum Producers (CAPP), formerly the Canadian Petroleum Association, the Canadian Energy Pipeline Association (CEPA) and various committees have been tracking this issue for over thirty years. To ensure that regulators, industry and other stakeholders are kept current on new initiatives from a regulatory and technical standpoint, CAPP, CEPA and the Canadian Gas Association (CGA) have updated the Third Edition, *Pipeline Associated Watercourse Crossings* (CAPP *et al.* 2005) with this Fourth Edition of *Pipeline Associated Watercourse Crossings*.

This document is intended to give regulators, industry practitioners and other stakeholders a summary of aspects of planning and constructing pipeline associated watercourse crossings. Its development is seen as a means to promote a consistent approach to pipeline associated watercourse crossings throughout Canada and to aid in developing a common understanding among industry, regulators and others (*e.g.*, nongovernment organizations). *Pipeline Associated Watercourse Crossings* strives to offer the reader options for consideration in the planning, review, approval and construction, as well as operations and maintenance, of pipeline associated watercourse crossings.

This document does not address any aspect of water withdrawal or discharge associated with hydrostatic testing. CAPP/CEPA have prepared a separate document on the regulatory and environmental requirements for hydrostatic testing in Canada (CAPP 1996).

In addition, this document does not address any aspect of wetlands and pipeline and vehicle crossings of wetlands. The regulatory and environmental requirements for wetlands often differ from watercourses and should be addressed separately.

1.1 Updates to Document

This edition concentrates on recent regulatory and technical advances in pipeline associated watercourse crossings. Much of the information is repeated from the Third Edition, *Pipeline Associated Watercourse Crossings* (CAPP *et al.* 2005), but has been updated with information from a consultation program involving key regulators from all jurisdictions as well as industry representatives. The

consultation program attempted to clarify objectives and information requirements from each jurisdiction, as well as tap the field expertise of industry representatives and regulatory agents as to their observations and recommendations regarding pipeline associated watercourse crossing construction.

This edition includes discussion related to changes to federal legislation resulting from the enactment in 2012 of the *Jobs, Growth and Long-term Prosperity Act* and the *Jobs and Economic Growth Act* (formerly Bills C-38 and C-45, respectively). However, not all of the changes were in force at the time this edition was published. This Fourth Edition should be seen as an interim document in effect until all of these legislative changes are in force and the federal government introduces any new regulations and policy associated with the new legislation. Once finalized, these changes to regulatory legislation and policy will impact the planning, construction, operation and maintenance of pipeline associated watercourse crossings.

The Third Edition of *Pipeline Associated Watercourse Crossings* was revised to incorporate Fisheries and Oceans Canada's (DFO) *Risk Management Framework for Development Projects Impacting Fish Habitat* and the Pathways of Effects (POE) models. As a component of their efforts to streamline the application and approval process for common development projects, DFO provided detailed comments of the technical aspects of this manual, as well as advised that approaches be based on selecting the correct watercourse crossing. Environmental impact (including mitigation and possibly compensation), navigation, the *Species at Risk Act* and other factors have been considered. Commentary on risk management during crossing selection and construction and cumulative environmental effects was added to the Third Edition.

The Fourth Edition of Pipeline Associated Watercourse Crossings has been revised to incorporate the DFO Habitat Compliance Decision Framework (DFO 2007a) which builds on the Practitioner's Guide to the Risk Management Framework (DFO 2005). The compliance framework provides information on the criteria used by DFO to determine if works are in compliance with the *Fisheries Act*. The Habitat Compliance Modernization (HCM) initiative deals specifically with remediation and enforcement. It is advisable to refer directly to the document where more detail is provided.

Comments on the Third Edition of this document were solicited from a variety of regulatory and industry sources in late 2011 and early 2012 and incorporated into this Fourth Edition. A draft of the Fourth Edition was circulated to those who responded with comments and again their input was incorporated into the document. This final version has since been reviewed by many practitioners active in the planning, construction and inspection of pipeline associated watercourse crossings, and takes into account their many years of collective experience.

1.2 Environmental Effects of Pipeline Watercourse Crossings

Aquatic resources can be affected adversely by watercourse crossing construction, specifically within the zone-of-influence (*i.e.*, the area of the watercourse that has been determined where 90% of the sediment load caused by construction activities is expected to fall out of suspension and be deposited). Potential environmental effects on aquatic habitat include:

- harmful alteration, disruption or destruction (HADD) of fish habitat including; instream, bank and riparian habitat at the crossing;
- elevated turbidity and increased deposition of sediment downstream arising from the release of silt during construction (clearing of the right-of-way banks, as well as trenching and backfilling of the channel);
- changes in water quality;
- interruption and/or reduction of flow within a watercourse; and
- introduction of invasive aquatic plants (*e.g.*, purple loosestrife, Eurasian milfoil).

Some factors that affect aquatic populations include:

- interruption of fish movements/migration upstream or downstream;
- increased stress to individuals;
- loss of or damage to key habitats needed for individual life-history stages;
- injury or mortality of fish associated with explosive charges used to facilitate trenching;
- injury or mortality of fish associated with improper operation and screening of water pump intakes;
- incidental mortality/injury associated with accidental release of toxic substances through spills; and
- introduction of disease, parasites or other pests detrimental to fish.

The adverse effects on fish of elevated total suspended solids (TSS) resulting from instream or riparian construction have been well documented. Numerous models have been developed to predict the effects of increased sediment loads on fish populations and their habitat downstream (Anderson *et al.* 1996). Lab and field studies provide evidence that pipeline crossings of watercourses can directly affect downstream physical habitat. Furthermore, flora and fauna can be affected either directly or indirectly by water crossing construction. The amount and duration of exposure to sediment and habitat disruption within a watercourse during and after construction influences the degree of effect on fish populations and their habitat.

1.2.1 Effects on Aquatic Habitat

Stream channel morphology is influenced by gradient (topography), basin catchment area, surficial and bedrock geology, channel substrate, amount of precipitation (average and extremes) and human and animal activity (beaver and

man-made dams or other impoundments). The distance that suspended and bedload sediment is transported along a watercourse is a function of particle size, water velocity and channel configuration. The smaller the particle size and steeper the gradient, the further it travels. Two classes of particles can affect fish habitat adversely: Silt and clay (diameter <62 microns) are readily suspended and travel farther than sand and coarser particles (diameter >62 microns), which are more likely to settle within a short distance of the crossing. Typically, it is the deposition of particles from the water column and the movement of bedload that can compromise aquatic habitat suitability for resident fish.

Elevated total suspended solids (TSS) and accelerated bedload movement can affect water quality, as well as alter channel morphology and streambed composition (Anderson *et al.* 1996). With traditionally trenched crossings, altered channel cross-sectional characteristics can arise following excavation and backfilling. In addition, particles carried by water are abrasive and their movement can physically erode channels (Anderson *et al.* 1996). If TSS levels remain elevated for a prolonged duration (days or weeks) during certain periods of the year, primary productivity of a watercourse can be inhibited downstream of the crossing.

Depending on the amount and type of substrate affected, and the duration of the effect, bedload movement can reduce substrate porosity, pool depth and riffle area. All three aspects can have negative consequences for fauna living downstream of the crossing. Reduced depth compromises a pool's ability to overwinter fish and can render it less suitable as a rearing and foraging habitat for juveniles and summer feeding and holding habitat for adults. Reduced riffle area results in a loss of oxygenated habitat suitable for benthic invertebrates, reduced diversity of benthic invertebrate communities downstream of the crossing, indirect loss of preferred prey for fish within the affected area, loss of spawning areas, loss of interstitial habitat for invertebrates and loss of interstitial nursery and rearing habitat for eggs and young fish.

Interruption or disruption of surface flows during open trenched watercourse crossings can produce areas immediately downstream that are dewatered and/or shallower than before the onset of the crossing. Habitat loss and/or mortality of fish and benthic invertebrates can occur due to stranding or reduced flow volumes. If suitable mitigation measures are not implemented, the timing, degree and duration of the disruption in streamflow dictates the consequences to aquatic resources downstream.

1.2.2 Effects on Fish Populations

In general, fish populations that inhabit coldwater watercourses are more sensitive to changes in TSS than populations in coolwater or warmwater habitats (Scott and Crossman 1973). Generally, fish populations that inhabit larger, slower flowing watercourses at lower elevations have evolved to tolerate higher suspended sediment concentrations. Since larger watercourses typically remain turbid for

longer periods of time, resident fish such as burbot (*Lota lota*), walleye (*Sander vitreus*), sauger (*Sander canadensis*), goldeye (*Hiodon alosoides*) and sucker spp. (*Catostomus spp.*) have adapted accordingly (Anderson *et al.* 1996).

Elevated TSS can affect fish individually through altered behaviour and/or physiology or, more generally, at the population level. Behavioural and physiological responses in fish are linked. In general, fish exposed to elevated levels of suspended sediment for extended periods experience biological (population) and physical (individual) stress. The degree of response is species and life-history stage specific (*i.e.*, egg, fry, juvenile, adult), and dictated by the magnitude and duration of exposure to the sediment plume.

Behavioural responses experienced by fish exposed to elevated TSS include suspension of territorial behaviour, depressed feeding rate and stimulated cough reflex. On experiencing discomfort, fish will move out of a sediment plume to ease the physical discomfort associated with gill abrasion if possible. Reduced feeding rate occurs in response to decreased instream visibility associated with elevated turbidity, TSS and stress in addition to reduced food supply. Increases in territoriality associated with movement out of the channel elevates biological stress both at the individual and population level as fish compete for less turbid territories, or establish new territories elsewhere within the system.

Physiological effects in fish exposed to elevated TSS are associated with stress, which can weaken an organism's immune system. Over extended periods, depressed feeding rates can be manifested in lower growth rate. Damaged gill filaments impair respiration and can lead to elevated stress, changes in blood chemistry, declines in overall fish health, reduced immune system function, increased vulnerability of an individual/population to disease and parasitism and, in the long term, reduced survival. Severe stress can lead to mortality once fish health is compromised.

Elevated sediment concentrations can affect fish further downstream of the crossing at the population level through increased egg mortality, decreased hatching success and loss of suitable spawning substrate. Like eggs, fish larvae have limited mobility and cannot avoid sedimentation of substrate or elevated TSS. Failed recruitment from eggs to larvae to juveniles ultimately affects annual production of a population within a watercourse. Similarly, loss of suitable spawning habitat as a consequence of sedimentation can adversely affect fish populations that rely on clean substrate for spawning and juvenile rearing.

1.2.3 Additional Consequences of Watercourse Crossings

Loss of riparian vegetation associated with clearing and/or grading of the banks to access a watercourse crossing can affect all life-history stages of fish. Clearing of riparian areas can locally raise water temperature within adjacent near shore shallow areas reducing their attractiveness as incubation, rearing, foraging and escape habitat for selected species. Loss of instream and overhead cover as a

result of right-of-way construction can reduce the habitat quality for resident fish populations. Cleared rights-of-way can become persistent sources of sediment to a watercourse if they are not suitably reclaimed. Introduction of sediment and increased water temperature can compromise water quality and the integrity of downstream aquatic habitat.

Crossings can create movement barriers that reduce fish distribution and abundance. On occasion contractors place large amounts of riprap over a pipeline, which can obstruct fish movement during periods of low flow. Furthermore, clearing and grading of rights-of-way at watercourse crossings can increase fish mortality indirectly, since improved access for anglers can expose previously remote sections of a watercourse to harvest.

The use of explosives can result in harm to fish habitat and/or mortality or injury of resident fish and invertebrates through damage to internal organs and crushing, as a consequence of the pressure wave associated with blasting. Mortality is influenced by factors such as water depth (*i.e.*, in shallow water much of the blast energy is released above the water), as well as the type and amount of explosive detonated, but tends to be limited to the immediate vicinity of the crossing. In addition, an accidental release of hazardous materials (*e.g.*, hydraulic fluid) from equipment or a fuel spill into a watercourse or within the riparian right-of-way, can lead to stress or fish kills at and downstream of the crossing.

Disruption of instream groundwater upwelling through sedimentation or disturbance to groundwater flows can adversely affect spawning habitat for salmonids and overwintering habitat.

The transfer of aquatic organisms between watersheds by dirty equipment or test water can lead to the introduction of weeds such as purple loosestrife (*Lythrum salicaria*) and Eurasian milfoil (*Myriophyllum spicatum*) as well as aquatic diseases, parasites or other pests such as whirling disease (*Myxobolus cerebralis*), zebra mussels (*Dreissena polymorpha*), didymo (*Didymosphenia geminata*) or exotic species not previously found in the watershed.

1.2.4 Natural Watercourse Dynamics

Natural storm and flood events can destabilize streambanks, create landslides within riparian zones and alter flow regimes within watercourses. It is the intensity and frequency of these events that ultimately influence channel morphology and the abundance, distribution and composition of resident fish and fish habitat. Natural flushing and stabilization of the system after an event permits recolonization and settlement of fish and benthic invertebrate populations within affected reaches. Watercourses are inherently dynamic and their fish populations have adapted to cope with natural catastrophic events. Landslides and floods can contribute large quantities of sediment, however, both typically occur when flows are high and dilution of sediment levels facilitates their tolerance by fish populations and transport downstream.

The cumulative effects of human activities within watercourses and riparian areas can magnify the outcome of a storm or flood event and prolonged, unnatural events can stress fish populations. Consequently, when designing pipeline crossings of watercourses, it is important to consider the degree of existing development in the area in conjunction with fish presence, distribution and habitat suitability for spawning, incubating, rearing, foraging, resting and overwintering at and immediately downstream of a proposed crossing.

1.3 Objectives for Watercourse Crossings

The overall goals and objectives of regulatory agencies for pipeline associated watercourse crossings are similar across Canada. However, there may be substantial variation in the construction techniques allowed as well as environmental protection and mitigation measures that are required for project approval among the various jurisdictions. The main guiding principle for all agencies across Canada, however, parallels the DFO guiding principle of ‘no net loss’ of productive capacity of fish habitat.

In addition, and consistent with the DFO guiding principle, the following goals and objectives have been identified by regional regulatory personnel to prevent or mitigate HADD on fish and fish habitat at watercourse crossings:

- minimize duration of time spent working instream;
- use the most practical construction method resulting in the least adverse effect;
- abide by instream timing restrictions (*i.e.*, avoid seasonal high risk periods within lifecycles of resident aquatic organisms);
- maintain clean water flow and eliminate where possible the release of sediment or suspended solids;
- minimize disturbance of the watercourse bed and banks;
- minimize erosion of the watercourse bed and banks;
- use sediment control measures when warranted;
- maintain downstream flow;
- restore riparian areas and crossing approaches to prevent or minimize the release of sediments into watercourses;
- maintain fish passage during instream construction activities;
- ensure that no deleterious materials (*e.g.*, sediment, fuel) are deposited into any watercourse;
- minimize cumulative effects of construction activities on the surrounding environment;
- fully mitigate all adverse effects of construction in a watercourse to minimize temporary and permanent fish habitat loss;
- restore hydraulic, hydrologic or hydrogeological characteristics of the watercourse to their pre-construction condition;
- ensure habitat compensation is implemented where harmful effects cannot be avoided or mitigated; and

- conduct post-construction/effectiveness monitoring using a multiple year program to assess the success of mitigation and/or compensation measures that were implemented and to document opportunities for procedural learning and improvement.

Ideally, proponents should use the above list to develop corporate watercourse crossing objectives or site-specific objectives for individual crossings or projects. Explicit watercourse crossing directives have the following benefits:

- facilitate consistent selection of appropriate crossing method;
- facilitate selection of most appropriate crossing locations;
- provide guidance to staff, contractors and regulators for approval, construction and monitoring;
- provide standard performance measures;
- allow proponents and contractors to evaluate crossing success;
- help proponents identify key risk areas and activities; and
- help proponents identify areas where cost or risk can be minimized with no adverse biophysical effects.

2 Regulatory and Information Requirements

The regulatory requirements for the construction, operation and abandonment of pipeline associated watercourse crossings in Canada vary according to the jurisdiction in which a project is being built. Each watercourse crossing may be subject to federal and provincial or territorial review. Many jurisdictional agencies have Codes of Practice, Operational Statements (OSs), guidelines and policies regarding watercourse crossings, and require a notification or application for permits, authorizations and licenses.

Sections 2.1 and 2.2 of this document describe the federal, provincial and territorial regulatory framework. Information requirements for each of these agencies are briefly discussed. This document has been written to reflect the regulatory information requirements at the time of publication. It does not address draft or proposed acts, Codes of Practice, OSs, guidelines or policies.

Table 2.1 provides a quick summary checklist of the regulatory framework and the appropriate contacts. Since the regulatory requirements are complex and continually changing across the country, the responsibility to ensure that all requirements are met falls on the proponent. Project planners should confirm with the appropriate agencies that the necessary permit applications are made and the regulatory requirements have been identified. Proponents should consult with regulatory authorities early in the planning process to ensure they understand the regulatory requirements.

2.1 Federal Jurisdictions

The *Jobs, Growth and Long-term Prosperity Act* and the *Jobs and Economic Growth Act* (formerly Bills C-38 and C-45, respectively) included changes to the following federal legislation related to the context of this document: the *Canadian Environmental Assessment Act*; the *National Energy Board Act*; the *Canada Oil and Gas Operations Act*; the *Fisheries Act*; the *Canadian Environmental Protection Act*; the *Species at Risk Act*; and the *Navigable Waters Protection Act*. At the time this Fourth Edition was published, some, but not all, of the legislative amendments resulting from the enactment of Bills C-38 and C-45 were in force; therefore, the Fourth Edition includes only the changes to the above mentioned acts that are in force as of November 2012.

There are nine federal acts that are most applicable to pipeline associated watercourse crossings in Canada:

- *Fisheries Act*;
- *Navigable Waters Protection Act*;
- *National Energy Board Act*;
- *Canadian Environmental Assessment Act, 2012*;
- *Indian Oil and Gas Act*;
- *Canada Oil and Gas Operations Act*;
- *Species At Risk Act*;
- *Migratory Birds Convention Act*; and
- *Constitution Act, 1982*.

Table 2.1 Regulatory and Information Contacts

Jurisdiction	Legislation	Contact
Federal	<i>Fisheries Act</i>	<ul style="list-style-type: none"> • Fisheries and Oceans Canada, Habitat Management Program, Regional Office
	<i>Navigable Waters Protection Act</i>	<ul style="list-style-type: none"> • Transport Canada, Navigable Waters Protection Program Regional Office
	<i>National Energy Board Act</i>	<ul style="list-style-type: none"> • National Energy Board
	<i>Canadian Environmental Assessment Act, 2012</i>	<ul style="list-style-type: none"> • Canadian Environmental Assessment Agency • Responsible Federal Authority (e.g., National Energy Board)
	<i>Indian Oil and Gas Act</i>	<ul style="list-style-type: none"> • Indian and Oil Gas Canada
	<i>Canada Oil and Gas Operations Act</i>	<ul style="list-style-type: none"> • National Energy Board
	<i>Species At Risk Act</i>	<ul style="list-style-type: none"> • Environment Canada, Canadian Wildlife Service
	<i>Migratory Birds Convention Act</i>	<ul style="list-style-type: none"> • Environment Canada, Canadian Wildlife Service
	<i>Constitution Act, 1982</i>	<ul style="list-style-type: none"> • Aboriginal Affairs and Northern Development Canada's Consultation Information Service, Treaties and Aboriginal Government and the Department of Justice
Alberta	<i>Environmental Protection and Enhancement Act</i>	<ul style="list-style-type: none"> • Alberta Environment and Sustainable Resource Development, Regulatory Approvals Centre, Enforcement and Monitoring Manager, Regional Office • Alberta Environment and Sustainable Resource Development, Fish and Wildlife, Regional and District Offices
	<i>Public Lands Act</i>	<ul style="list-style-type: none"> • Alberta Environment and Sustainable Resource Development, Public Lands and Forest, Regional Office
	<i>Water Act</i>	<ul style="list-style-type: none"> • Alberta Environment and Sustainable Resource Development, Water Management, Regional Office
British Columbia	<i>Environmental Assessment Act</i>	<ul style="list-style-type: none"> • British Columbia Ministry of Environment, Environmental Assessment Office
	<i>Fish Protection Act including the Riparian Areas Regulation</i>	<ul style="list-style-type: none"> • British Columbia Ministry of Environment, Environmental Stewardship Division, Regional Operations • British Columbia Ministry of Forests, Lands and Natural Resource Operations
	<i>Forest Range And Practices Act</i>	<ul style="list-style-type: none"> • British Columbia Ministry of Forests, Lands and Natural Resource Operations
	<i>Land Act</i>	<ul style="list-style-type: none"> • British Columbia Ministry of Forests, Lands and Natural Resource Operations
	<i>Oil and Gas Activities Act (OGAA) and the OGAA Environmental Protection and Management Regulation</i>	<ul style="list-style-type: none"> • British Columbia Oil and Gas Commission, Regional Office

Table 2.1 Regulatory and Information Contacts, Cont'd

Jurisdiction	Legislation	Contact
British Columbia cont'd	<i>Water Act</i>	<ul style="list-style-type: none"> British Columbia Ministry of Environment, Environmental Stewardship Division and Water Stewardship Division, Regional Operations British Columbia Ministry of Forests, Lands and Natural Resource Operations, FrontCounter British Columbia
Manitoba	<i>Crown Lands Act</i>	<ul style="list-style-type: none"> Manitoba Infrastructure and Transportation, Crown Lands and Property Agency
	<i>Environment Act</i>	<ul style="list-style-type: none"> Manitoba Conservation and Water Stewardship, Climate Change and Environmental Protection Division, Environmental Assessment and Licensing Branch
	<i>Water Resources Administration Act</i>	<ul style="list-style-type: none"> Manitoba Conservation and Water Stewardship, Regulatory and Operational Services Division
	<i>Water Rights Act</i>	<ul style="list-style-type: none"> Manitoba Conservation and Water Stewardship, Regulatory and Operational Services Division
	<i>Water Protection Act</i>	<ul style="list-style-type: none"> Manitoba Conservation and Water Stewardship, Ecological Services Division
New Brunswick	<i>Clean Environment Act</i>	<ul style="list-style-type: none"> New Brunswick Department of Environment, Sustainable Development, Planning and Impact Evaluation (Branch)
	<i>Clean Water Act</i>	<ul style="list-style-type: none"> New Brunswick Department of Environment, Sustainable Development, Planning and Impact Evaluation (Branch), Water and Wetland Alteration Program
	<i>Crown Lands and Forest Act</i>	<ul style="list-style-type: none"> New Brunswick Department of Natural Resources, Crown Lands Branch
Newfoundland and Labrador	<i>Water Resources Act</i>	<ul style="list-style-type: none"> Newfoundland and Labrador Department of Environment and Conservation, Water Resources Management Division
	<i>Environmental Protection Act</i>	<ul style="list-style-type: none"> Newfoundland and Labrador Department of Environment and Conservation, Environmental Assessment Division
Northwest Territories (Unsettled claims areas and transboundary projects)	<i>Mackenzie Valley Resource Management Act</i>	<ul style="list-style-type: none"> Mackenzie Valley Land and Water Board
Northwest Territories (Inuvialuit Lands)	<i>Inuvialuit Final Agreement</i>	<ul style="list-style-type: none"> Inuvialuit Land Administration
	<i>Territorial Lands Act</i>	<ul style="list-style-type: none"> Aboriginal Affairs and Northern Development Canada, Northwest Territories Region
	<i>Northwest Territories Waters Act</i>	<ul style="list-style-type: none"> Northwest Territories Water Board
Northwest Territories (Gwich'in Lands)	<i>Gwich'in Final Agreement</i>	<ul style="list-style-type: none"> Gwich'in Tribal Council
Northwest Territories (Gwich'in Lands) cont'd	<i>Mackenzie Valley Resource Management Act</i>	<ul style="list-style-type: none"> Gwich'in Land and Water Board
	<i>Northwest Territories Waters Act</i>	<ul style="list-style-type: none"> Gwich'in Land and Water Board
Northwest Territories (Sahtu Lands)	<i>Sahtu Dene and Metis Comprehensive Land Claim Agreement</i>	<ul style="list-style-type: none"> Sahtu Tribal Council

Table 2.1 Regulatory and Information Contacts, Cont'd

Jurisdiction	Legislation	Contact
Northwest Territories (<i>Sahtu Lands</i>) cont'd	<i>Mackenzie Valley Resource Management Act</i>	<ul style="list-style-type: none"> • Sahtu Land and Water Board
	<i>Northwest Territories Waters Act</i>	<ul style="list-style-type: none"> • Sahtu Land and Water Board
Northwest Territories (<i>Tlicho Lands</i>)	<i>Tlicho Final Agreement</i>	<ul style="list-style-type: none"> • Tlicho Government
	<i>Mackenzie Valley Resource Management Act</i>	<ul style="list-style-type: none"> • Wek'eezhii Land and Water Board
	<i>Northwest Territories Waters Act</i>	<ul style="list-style-type: none"> • Wek'eezhii Land and Water Board
Nova Scotia	<i>Crown Lands Act</i>	<ul style="list-style-type: none"> • Nova Scotia Department of Natural Resources, Land Services Branch
	<i>Environment Act</i>	<ul style="list-style-type: none"> • Nova Scotia Department of Environment and Labour, Environmental Monitoring and Compliance Division
Nunavut	<i>Nunavut Land Claim Agreement</i>	<ul style="list-style-type: none"> • Aboriginal Affairs and Northern Development Canada, Nunavut Region • Nunavut Planning Commission, Regional Planning Office • Nunavut Impact Review Board
	<i>Territorial Lands Act</i>	<ul style="list-style-type: none"> • Aboriginal Affairs and Northern Development Canada, Nunavut Region
	<i>Nunavut Waters and Nunavut Surface Rights Tribunals Act</i>	<ul style="list-style-type: none"> • Nunavut Water Board
Ontario	<i>Conservation Authorities Act</i>	<ul style="list-style-type: none"> • Ontario Conservation Authority • Local Authority
	<i>Environmental Assessment Act</i>	<ul style="list-style-type: none"> • Ontario Ministry of Environment, Environmental Approvals Access and Service Integration Branch
	<i>Environmental Protection Act</i>	<ul style="list-style-type: none"> • Ontario Ministry of Environment, Environmental Approvals Access and Service Integration Branch
	<i>Lakes and Rivers Improvement Act</i>	<ul style="list-style-type: none"> • Ontario Ministry of Natural Resources
	<i>Public Lands Act</i>	<ul style="list-style-type: none"> • Ontario Ministry of Natural Resources
	<i>Ontario Water Resources Act</i>	<ul style="list-style-type: none"> • Ontario Ministry of Environment, Environmental Approvals Access and Service Integration Branch
	<i>Ontario Energy Board Act</i>	<ul style="list-style-type: none"> • Ontario Energy Board, Ontario Pipeline Coordinating Committee
Prince Edward Island	<i>Environmental Protection Act</i>	<ul style="list-style-type: none"> • Prince Edward Island Department of Environment, Labour and Justice
Québec	<i>Loi sur la conservation et la mise en valeur de la faune (Conservation and development of wildlife act)</i>	<ul style="list-style-type: none"> • Ministère des Ressources naturelles et de la Faune
	<i>Loi sur la qualité de l'environnement (Environmental quality act)</i>	<ul style="list-style-type: none"> • Ministère du Développement durable, de l'Environnement et des Parcs
Saskatchewan	<i>Environmental Assessment Act</i>	<ul style="list-style-type: none"> • Saskatchewan Ministry of Environment, Senior Ecological Protection Specialist

Table 2.1 Regulatory and Information Contacts, Cont'd

Jurisdiction	Legislation	Contact
Saskatchewan cont'd	<i>The Environmental Management and Protection Act</i>	<ul style="list-style-type: none"> Saskatchewan Ministry of Environment, Senior Ecological Protection Specialist
	<i>Saskatchewan Watershed Authority Act</i>	<ul style="list-style-type: none"> Saskatchewan Watershed Authority
Yukon	<i>Yukon Environmental and Socioeconomic Assessment Act</i>	<ul style="list-style-type: none"> Yukon Government Executive Council Office, Development Assessment Process Branch <i>Yukon Environmental and Socioeconomic Assessment Act</i> Board
	<i>Territorial Lands (Yukon) Act</i>	<ul style="list-style-type: none"> Yukon Department of Energy, Mines and Resources Yukon Land Use Planning Council
	<i>Waters Act</i>	<ul style="list-style-type: none"> Yukon Water Board

2.1.1 Fisheries Act

As discussed in the Overview, as a result of the enactment of the *Jobs, Growth and Long-term Prosperity Act* and the *Jobs and Economic Growth Act* (formerly Bills C-38 and C-45, respectively) amendments have been made to the *Fisheries Act* that were not in force as of the date of this Fourth Edition. The following discussion reflects provisions of the *Fisheries Act* as currently in force. The accompanying policy changes associated with the amendments to the *Fisheries Act* have not been completed. Policy changes to support the *Fisheries Act* amendments are expected in 2013.

The federal *Fisheries Act* was enacted to protect fish, fish habitat and water frequented by fish and to provide for sustainable fisheries in Canada. Responsibility for the *Fisheries Act* rests with the Minister of Fisheries and Oceans (MFO). Fisheries and Oceans Canada (DFO) administers the habitat protection provisions (Section 35) of the *Fisheries Act*, while Environment Canada, under a 1985 Memorandum of Understanding with DFO, administers those provisions of the *Fisheries Act* dealing with the control of pollution (Section 36).

There are ten sections in the *Fisheries Act* (paraphrased below) most likely to pertain to pipeline associated watercourse crossings:

- Section 20 Provides for safe passage of fish.
- Section 22 Provides for flow of water and passage of fish.
- Section 30 Provides for water diversions or intakes to have a fish guard or screen.
- Section 32 Prohibits the destruction of fish by any means other than fishing except as authorized by the MFO or regulation.

- Subsection 35(1) Prohibits works or undertakings that result in harmful alteration, disruption or destruction (HADD) of fish habitat.
- Subsection 35(2) Allows for the authorization of HADD by the MFO.
- Subsection 36(3) Prohibits the deposition of deleterious substances in waters frequented by fish.¹
- Subsection 37(1) Where HADD of fish habitat or a deposit of deleterious substance results or is likely to result from an existing or proposed work or undertaking, the MFO may request plans and specifications to be submitted for review.
- Subsection 37(2) Where the Minister is of the opinion that contravention of ss.35(1) or ss.36(3) is being or is likely to be committed, the MFO may order modification, restrict or close an undertaking subject to Governor in Council approval.
- Subsection 38(6) Allows for enforcement of inspector's orders.

Additional Sections of the *Fisheries Act* (e.g., Sections 2, 34) provide definitions, such as those summarized in the Glossary. Other Sections (e.g., Sections 40, 42, 78, 79) describe matters such as fines, offences and penalties.

Failure to comply with the habitat protection or pollution prevention provisions of the *Fisheries Act* may result in charges being laid. A court, upon conviction for offences under these provisions, may impose fines and court orders. For example, upon conviction of an indictable offence, a person found guilty of contravening Subsection 35(1) is liable to a fine not exceeding 1 million dollars for a first offence.

DFO has developed tools to promote the protection of fish and fish habitat, the foremost of which is the *Policy for the Management of Fish Habitat* (DFO 1986). Additional guidance and advice are provided in the following documents.

- *Habitat Management Program: Standard Operating Policies* including:
 - *Application of the Habitat Protection Provisions of the Fisheries Act to Existing Facilities and Structures* (DFO 2007b);
 - *Habitat Compliance Decision Framework* (DFO 2007a);
 - *Position Statement on the Management of Fish Mortality* (DFO 2009a);
 - *Practitioners Guide to the Risk Management Framework* (DFO 2005);
 - *Practitioners Guide to Writing Letters Used in and for Fisheries Act and Species at Risk Act Reviews* (DFO 2007c);
 - *Practitioners Guide to Habitat Compensation* (DFO 2006a);
 - *Practitioners Guide to Writing an Authorization for the Application of the Habitat Protection Provisions of the Fisheries Act* (DFO 2012);
 - *Practitioners Guide to Letters of Credit* (DFO 2006b); and
 - *Practitioners Guide to Fish Passage for DFO Habitat Management Staff* (DFO 2007d).
- *Freshwater Intake End-of-Pipe Fish Screen Guideline* (DFO 1995a).

¹ Enforced by Environment Canada.

- *Proponent's Guide To Information Requirements For Review under The Fish Habitat Protection Provisions Of The Fisheries Act* (DFO 2009b).

The documents listed in the *Habitat Management Program: Standard Operating Policies* above were implemented in 2006, replacing the following documents.

The following documents are no longer relevant as of 2006.

- *Fish Habitat Conservation and Protection: Guidelines for Attaining No Net Loss* (DFO 1995b).
- *Fish Habitat Conservation and Protection: What the Law Requires - The Directive on the Issuance of Subsection 35(2) Authorizations*: (DFO 1995c).
- *Decision Framework for the Determination and Authorization of Harmful Alteration, Disruption or Destruction of Fish Habitat* (DFO 1998).
- *Habitat Conservation and Protection Guidelines* (DFO 1999).

DFO developed the Risk Management Framework as part of the Environmental Process Modernization Plan (DFO 2005). From that document, DFO has developed OSs to streamline its review and approval process for works that are low risk to fish habitat. Low risk activities can proceed without review by DFO if the conditions and Measures to Protect Fish and Fish Habitat in the applicable OSs for the work are met. Notification to DFO is requested prior to the commencement of the proposed works. The OS and notification forms have been developed separately among regions and are different between provinces. For example, review by DFO is required for all trenched crossings when water is present for pipeline crossings in the Pacific Region. However, there is an OS for isolated trenched crossings in Alberta. Therefore, if all of the conditions and measures in the Alberta OS can be met for an isolated trenched crossing in Alberta, review by DFO Central and Arctic Region is not required.

Table 2.2 lists the OSs for each province/territory related to pipeline crossings and associated works. If there is no OS for the work or if the work does not meet all the conditions and measures in the OS, review by DFO is required. New versions of the OS and/or new OS may be available, it is up to the proponent to ensure they are following the most current version.

Table 2.2 Fisheries and Oceans Canada’s Operational Statements Applicable to Pipeline Associated Watercourse Crossings Across Canada as of May 15, 2012.

Province/Territory	High-pressure Directional Drilling	Isolated or Dry Open-cut Stream Crossings ¹	Dry Open-cut Stream Crossings ²	Punch and Bore Crossings	Clear Span Bridges	Ice Bridges and Snow Fills	Temporary Stream Crossing ³	Temporary Ford Stream Crossing ⁴	Beaver Dam Removal	Bridge Maintenance	Culvert Maintenance	Maintenance of Riparian Vegetation in Existing Rights-of-Way	Timing Windows
Alberta	√	√		√	√	√	√		√	√	√	√	
British Columbia	√		√	√	√	√		√		√	√	√	
Manitoba	√	√		√	√	√	√		√	√	√	√	√
New Brunswick ⁵	√			√	√	√			√	√	√	√	
Newfoundland and Labrador	√			√	√	√	√		√	√	√	√	
Northwest Territories	√	√		√	√	√	√			√	√	√	√
Nova Scotia	No Operational Statements, the Nova Scotia Department of Environment and Labour is the first contact for activities occurring in and around freshwater												
Nunavut					√	√	√			√	√		
Ontario	√	√		√	√	√	√		√	√	√	√	√
Prince Edward Island ⁵	√			√	√				√	√	√	√	
Québec	√	√		√	√	√	√			√		√	
Saskatchewan	√	√		√	√	√	√		√	√	√	√	√
Yukon	√		√	√	√	√		√		√	√	√	

Notes:

1. Pertains to a trenched pipeline watercourse crossing in which the natural flow is diverted using flume or dam and pump techniques or the watercourse is dry or frozen to bottom at the time of construction.
2. Pertains only to a trenched pipeline watercourse crossing in which the watercourse is dry or frozen to bottom at the time of construction.
3. Pertains to a one-time ford in flowing watercourses, a seasonally dry streambed ford, or a temporary bridge (e.g., Bailey bridge or log stringer bridge).
4. Pertains only to either a one-time ford in flowing watercourses or a seasonally dry streambed ford.
5. No separate Operational Statements exist but are incorporated into provincial guidelines as part of collaborations between DFO and the provincial regulators.

In its review of project proposals, DFO applies the guiding principle of ‘no net loss’ of the productive capacity of fish habitat. Under this principle, DFO strives to balance unavoidable habitat loss with habitat replacement on a project-by-project basis. A more detailed discussion of habitat compensation appears in Section 6.0 of this document.

Section 35 of the *Fisheries Act* prohibits the HADD of fish habitat except where authorized by the MFO. Documents noted above, such as *Habitat Management Program: Standard Operating Policies* provide additional guidance to proponents. Section 58 and Schedule VI of the Fishery (General) Regulations provide the forms that applicants for Subsection 35(2) Authorizations may use.

Where proponents are planning a watercourse crossing that has a high risk of HADD, they must contact the appropriate regulatory authorities and technical specialists to discuss the project. It should be noted that DFO has developed working relationships with a number of other agencies and initial contact may differ throughout the country (see Section 2.2 of this document). Proponents are advised to familiarize themselves with local working relationships between DFO and other agencies. If after reviewing the information the regulatory decision is that HADD is not likely to result or can be mitigated, a letter of advice may be provided to the proponent that outlines the measures required to avoid HADD. Should the proponent not implement the measures or change the project and HADD occurs, charges under the *Fisheries Act* could be brought against the proponent.

In cases where it is not possible to protect fish habitat by mitigation or project design, a Subsection 35(2) Authorization may be issued. In accordance with DFO’s policy, an Authorization will stipulate the conditions necessary to achieve ‘no net loss’ of productive capacity of fish habitat (*i.e.*, compensation measures). Authorizations may not be issued in all cases.

Section 32 of the *Fisheries Act* prohibits the destruction of fish by means other than fishing except as where authorized by DFO. Section 32 may apply in situations where a proponent is planning the use of explosives for a watercourse crossing. Additional details regarding the use of explosives in watercourses are provided in sections 5.2.7 and 7.1.6 of this document.

Since the 1990’s, DFO has assumed greater responsibility with regards to consulting with Aboriginal communities. DFO will take into consideration Aboriginal community rights and their use of fish and fish habitat when reviewing proposed work. Refer to Section 2.1.9 of this document for discussion of the *Constitution Act, 1982*. Proponents should consult with provincial, territorial and federal authorities and technical specialists for information on Aboriginal community rights and their use of resources in the vicinity of proposed work.

2.1.2 Navigable Waters Protection Act

As discussed in the Overview, as a result of the enactment of the *Jobs and Economic Growth Act* (formerly Bill C-45) amendments have been made to the *Navigable Waters Protection Act* that were not in force as of the date of this Fourth Edition. The following discussion reflects provisions of the *Navigable Waters Protection Act* as currently in force.

The *Navigable Waters Protection Act* (*NWPA*) provides a legislative mechanism for the protection of the public right of marine navigation on all navigable waterways in Canada. This is accomplished through permitting of the construction of works built or placed in, over, through or across navigable waterways and through a legal framework to deal with obstacles and obstructions to navigation. The *NWPA* is administered by the Navigable Waters Protection Program (NWPP) of Transport Canada (TC).

A navigable waterway is defined as being any body of water capable of being navigated by floating vessels of any description for the purpose of transportation, commerce or recreation. This includes both inland and coastal waters. The authority to determine the navigability of a waterway rests with the Minister of Transport or his/her designated representative.

The pertinent sections of the *NWPA* for pipeline associated watercourse crossings are found in:

- Paragraph 5(1)(a) No work shall be built or placed in, on, over, under, through or across any navigable water unless the work, the site and plans thereof have been approved by the Minister, on such terms and conditions as the Minister deems fit, prior to commencement of construction.
- Subsection 5(2) Except in the case of a bridge, boom, dam or causeway, paragraph 5(1)(a) does not apply to any work that in the opinion of the Minister does not interfere substantially with navigation.

In 2009, amendments to the *NWPA* titled the *Minor Works and Waters (NWPA) Ministerial Order* (Canada Gazette 2009) came into force as a federal government initiative to streamline major resource and infrastructure project applications. This process establishes classes of navigable waters and works that do not require application/notification under the *NWPA* since they are considered ‘minor works’ or on ‘minor navigable waters’.

A proponent may use the *Minor Works and Waters (NWPA) Ministerial Order* (Canada Gazette 2009) to determine the need to submit a determination of navigability and/or an application to NWPP. If all the works on the proposed watercourse crossings meet the criteria of the *Minor Works and Waters (NWPA) Ministerial Order* (Canada Gazette 2009), then notification to NWPP of the project is not required. It is important to note that if the watercourses meet the

criteria it does not mean that they are not navigable, it means they are ‘minor works’ or on a ‘minor navigable water’ and mitigation outlined in the *Minor Works and Waters (NWPA) Ministerial Order* (Canada Gazette 2009) must be implemented during the work. The proponent does not need to implement the mitigation outlined in the *Minor Works and Waters (NWPA) Ministerial Order* (Canada Gazette 2009) if the proposed watercourse crossings are not navigable. If the proponent is not aware if the watercourse is navigable, a determination of navigability should be submitted to NWPP.

The criteria for determining if the work is a ‘minor work’ or is on a ‘minor navigable water’ is outlined in the *Minor Works and Waters (NWPA) Ministerial Order* (Canada Gazette 2009). The Sections in the *Minor Works and Waters (NWPA) Ministerial Order* applicable to pipeline associated watercourse crossings include: Section 2 (Erosion Protection Works); Section 4 (Winter Crossings); Section 7 (Pipeline Crossings); Section 8 (Water Intakes); Section 9 (Dredging); Section 10 (Temporary Works); and Section 11 (Minor Navigable Waters). Several brochures have been developed by Transport Canada for the ‘minor works’, the applicable brochures for pipeline associated crossings are: Pipeline Crossings (Transport Canada 2009a), Erosion Protection Works (Transport Canada 2009b), Dredging (Transport Canada 2009c), Winter Crossings (Transport Canada 2009d), Water Intakes (Transport Canada 2009e), Temporary Works (Transport Canada 2009f) and the Minor Waters User Guide (Transport Canada 2010a).

If any works on the proposed watercourse crossings do not meet the criteria of the *Minor Works and Waters (NWPA) Ministerial Order* (Canada Gazette 2009), a determination of navigability should be submitted to determine if the watercourse is navigable. If NWPP determines the watercourse to be navigable, then an application for the work is required under the *NWPA* and must be submitted to NWPP. The information required for a determination of navigability and an application can be obtained by contacting a NWPP regional office.

Projects that cross navigable waters and are not regulated by the National Energy Board (NEB) under the *NEB Act*, are not ‘minor works’ or are not on ‘minor navigable waters’ require either determination or approval under the *NWPA*. Projects are normally processed under Subsection 5(2) of the *NWPA* and a Subsection 5(2) determination is issued if the project does not interfere substantially with navigation. Proponents must submit a letter of application and plan information to the Regional NWPP Office of TC and notify the NWPP inspector when construction is finished so that a final inspection may be conducted to verify that all plans and recommendations were followed.

Projects in which construction has the potential to substantially interfere with navigation are dealt with under Subsection 5(1) and require a more formal approval process. Initial submissions for an approval include a letter of application, site and construction drawings, authorization by owner and

environmental assessment documentation. Application information is available on the Transport Canada website and by contacting a regional office.

Projects that are regulated by the NEB must obtain leave from Transport Canada to cross navigable waters under Section 108 of the *NEB Act*. More details regarding this approval are provided in Section 2.1.3 of this document.

Aboriginal consultation by NWPP forms part of the approval process and the TC Aboriginal Consultation Unit must sign off on approvals. Proponents are required to submit Aboriginal consultation information to NWPP. This may or may not be sufficient for the approval process to proceed. For example, in the Prairie and Northern Region, if the TC Aboriginal Consultation Unit deems it necessary to conduct Aboriginal consultation, the TC Aboriginal Consultation Unit will send notification letters to the Aboriginal communities involved and they have 30 days to respond. The TC Aboriginal Consultation Unit has the responsibility to determine if the proposed work infringes on Aboriginal navigation rights.

2.1.3 National Energy Board Act

As discussed in the Overview, as a result of the enactment of the *Jobs, Growth and Long-term Prosperity Act* (formerly Bill C-38) amendments have been made to the *National Energy Board (NEB) Act*; most, but not all of these amendments are in force as of the date of this Fourth Edition. The following discussion reflects provisions of the *NEB Act* as currently in force.

The *National Energy Board Act* is an independent federal agency established in 1959 by the Parliament of Canada to regulate international and interprovincial aspects of the oil, gas and electric utility industries. The NEB's purpose is to promote safety, environmental protection and economic efficiency in the Canadian public interest within the mandate set by Parliament in the regulation of pipelines, energy development and trade. Under the *NEB Act*, the NEB has assumed a mandate for environmental protection as a component of the public interest. The NEB also has responsibilities under the *Canadian Environmental Assessment Act, 2012 (CEAA, 2012)* to ensure that projects receive appropriate levels of assessment before proceeding. The NEB's environmental responsibility includes ensuring that the environment is protected during planning, construction, operation and abandonment of energy projects within its jurisdiction.

The NEB regulates:

- interprovincial and international pipelines;
- pipeline transportation, tolls and tariffs;
- international and designated Interprovincial power lines;
- exports of oil, natural gas and electricity; and
- frontier oil and gas activities (*Canada Oil and Gas Operations Act*) outside of Accord areas.

The NEB also regulates activities on or adjacent to rights-of-way under NEB jurisdiction in the interests of protection of property and the environment as well as the safety of the public and of the pipeline company's employees.

Before a company can conduct any pipeline construction work on a NEB-regulated project, it must apply for, and receive approval for the project from the NEB before it can build a pipeline, make changes to it, sell it or abandon it. To submit an application, the company must follow the *NEB Act*, the *NEB Rules of Practice and Procedure* (Government of Canada 1995, 2009) and the *NEB Filing Manual* (NEB 2004) and other legislation and regulations such as the *CEAA, 2012* that may be relevant. The application involves the preparation of an Environmental and Socio-economic Assessment (ESA). Pipeline associated watercourse crossing requirements include information on fish and fish habitat and traditional land and resource use. Companies preparing an application are required to anticipate the environmental issues and concerns created by the proposed project and to consult with appropriate government bodies, public interest groups, Aboriginal persons and affected landowners.

The application will describe:

- the purpose of the pipeline;
- the pipeline design;
- environmental impacts of the project;
- if any public consultations have been held;
- any land rights needed;
- the adequacy of supply and the market potential for the products it will carry;
- the economics of the pipeline;
- the proposed route corridor; and
- any other factors that may affect the NEB's decision.

Once the application has been submitted and filed, the NEB becomes directly involved with the project as the application is now a formal request for approval. It is the responsibility of the NEB to consider all aspects of the project in order to determine if the pipeline project is in the public interest.

Recent amendments to the *NEB Act* have introduced time limits for the approval process. The time limit is specified by the NEB Chair but cannot be longer than 15 months from the date upon which the NEB has determined that an application is complete. Time limits may only be extended by the Minister for a maximum of three months and by Cabinet for an additional period of time. Public hearings may be conducted orally or through written correspondence and documents only. Both processes allow for public participation, although recent amendments to the *NEB Act* now limit representations to any person who is directly affected or who has relevant information or expertise. A panel of NEB board members hears the evidence and then submits its report to the Minister with a recommendation to approve or deny an application. If the application relates to a 'designated project' within the meaning of the *CEAA, 2012* (explained below), the report must also set

out the NEB's environmental assessment prepared under that Act. Cabinet may order the NEB to reconsider its report, issue the certificate or dismiss the application.

The NEB can monitor the company's performance in several ways, one of which is through field inspections carried out by NEB Inspection Officers and specialized staff. They monitor the company's activities to make sure it is meeting the conditions that the NEB has set.

2.1.4 Canadian Environmental Assessment Act, 2012

As discussed in the Overview, as a result of the enactment of the *Jobs, Growth and Long-term Prosperity Act* and the *Jobs and Economic Growth Act* (formerly Bills C-38 and C-45, respectively) the former *CEAA* was repealed and replaced with *CEAA, 2012*. The following discussion reflects provisions of *CEAA, 2012* as currently in force.

The *Canadian Environmental Assessment Act, 2012 (CEAA, 2012)* came into force on July 6, 2012 to ensure environmental review (including cumulative effects assessment and public consultation) on a project specific basis. Under *CEAA, 2012*, a physical activity is a 'designated project' either as defined by regulation or by Ministerial order. The responsible authority (RA) is either the NEB for designated projects regulated under the *NEB Act* or the *Canada Oil and Gas Operations Act*, or the Canadian Nuclear Safety Commission (CNSC) for designated projects regulated under the *Nuclear Safety and Control Act*. For designated projects that do not fall within the purview of the NEB or the CNSC, the RA is the CEA Agency. These include, for example, non-NEB regulated pipelines of more than 75 km in length on new right-of-way (*i.e.*, certain provincially-regulated pipelines). Designated projects for which the RA is either the NEB or the CNSC (or another federal authority if specified by subsequent regulation), or where an activity has become a designated project by Ministerial order, an environmental assessment is required. For other designated projects, the CEA Agency will conduct a screening first to determine whether an environmental assessment is required.

Environmental assessments conducted by the RA are conducted in accordance with *CEAA, 2012* and must consider cumulative effects caused by the project in combination with other projects or activities that have been or will be carried out. Cumulative effects evaluations consider the combined effects now known to take place over larger study areas and longer time frames. While much of the focus of the environmental assessments is related to issues regarding watercourses, an overall assessment of the project's requirements is otherwise directed by the minister. The level of effort should be appropriate to the number of crossings being considered, other existing watershed disturbances, and the combined risk to fish and fish habitat. Additional information is provided in Sections 4.3.3 and 4.3.4 of this document.

In addition to environmental assessments for designated projects, *CEAA, 2012* also stipulates that a project on federal lands cannot be carried out unless the federal authority exercising any power, duty or function (*i.e.*, issuance of a permit or license, etc.) determines that the project is not likely to cause significant adverse environmental effects.

Information regarding content and process for all levels of environmental assessments is described in the *CEAA* documents, such as *The Responsible Authorities Guide to the Canadian Environmental Assessment Act* (CEA Agency 1994) and *Addressing Cumulative Environmental Effects under the Canadian Environmental Assessment Act* (CEA Agency 2007). The CEA Agency cooperates with provincial and territorial environmental assessment regulators and agreements have been made to foster greater efficiency and cooperation between both governments. These agreements apply to projects where an environmental assessment is required under both the *CEAA, 2012* and the applicable provincial or territorial act. In such cases only a single assessment is required and one government takes the lead in administering the assessment, but both governments are full and active participants. The following Agreements are in place:

- Canada - Alberta Agreement for Environmental Assessment Cooperation, 2005;
- Canada - British Columbia Agreement for Environmental Assessment Cooperation, 2004;
- Canada - Manitoba Agreement on Environmental Assessment Cooperation, 2007;
- Canada – Draft Newfoundland and Labrador Agreement for Environmental Assessment Cooperation, 2005;
- Canada - Ontario Agreement on Environmental Assessment Cooperation, 2004;
- Canada - Quebec Agreement on Environmental Assessment Cooperation, 2010;
- Canada - Saskatchewan Agreement on Environmental Assessment Cooperation, 2005; and
- Canada - Yukon Agreement on Environmental Assessment Cooperation, 2004.

2.1.5 Indian Oil and Gas Act

The *Indian Oil and Gas Act* is administered by Indian Oil and Gas Canada. The *Act* pertains to all oil and gas activities on Indian reserve land in Canada south of the 60th parallel. Proponents of a pipeline transporting products from a well located on reserve lands that entails a watercourse crossing on reserve lands will require approval from Indian Oil and Gas Canada. It should be noted that proponents of pipelines that traverse reserve lands but do not transport products from a well on reserve lands must conduct an EA under *CEAA, 2012*. In the event that watercourse crossings are proposed within land claim areas, proponents are

advised to discuss the project with AANDC, Indian Oil and Gas Canada and DFO.

2.1.6 Canada Oil and Gas Operations Act.

The *Canada Oil and Gas Operations Act* is administered by the NEB. The *Act* applies to the exploration, drilling, production, conservation, processing and transportation of oil and gas in the Northwest Territories, Nunavut, Sable Island, or offshore waters of Canada (not including interprovincial and international transmission pipelines, which are regulated by the *NEB Act*). Proponents are required to submit an application, as per the regulations, to the NEB, for a watercourse crossing in these areas. Proponents operating in Nova Scotia and Newfoundland and Labrador will also have to recognize the Atlantic Accords between the federal government and these provinces.

2.1.7 Species at Risk Act

The *Species at Risk Act* (SARA) is administered primarily by Environment Canada, Canadian Wildlife Service with assistance from DFO for aquatic species and Parks Canada Agency for species on federal lands that are protected as defined in the *Parks Canada Agency Act*. SARA automatically protects all listed species at risk on federal lands. This includes national parks, national marine conservation areas, national historic sites and other protected heritage areas administered by Parks Canada. All migratory birds listed by the *Migratory Birds Convention Act* on any lands and all listed aquatic species as defined by the *Fisheries Act* in any waterbody are also automatically protected. Under SARA, provincial and territorial governments are given the first opportunity to protect species and critical habitat found on non-federal lands. However, if necessary, the federal government may order that certain SARA restrictions apply on provincial or territorial lands.

SARA prohibits killing, harming or harassing listed species, trading in the parts of listed species and damaging or destroying the residence of an individual of a listed species. Proponents should ensure that no listed species at risk could be affected by their project.

2.1.8 Migratory Birds Convention Act

The *Migratory Birds Convention Act* is administered by Environment Canada, Canadian Wildlife Service. The *Act* implements a treaty between Canada and the United States that coordinates a system to prevent the indiscriminate harvest or destruction of migratory birds. The *Act* specifically prohibits the destruction of the nest, eggs and young of migratory birds but does not specifically protect habitat. Disruption of nests located in riparian habitat by watercourse crossing projects may have implications under the *Act*.

2.1.9 Constitution Act, 1982

In November 2007, the Government of Canada enacted an Action Plan on consultation and accommodation based on the judicial interpretation and obligation of the Crown (federal, provincial and territorial governments) to protect Aboriginal or Treaty rights set forth in Section 35 (1) of the *Constitution Act, 1982*. This duty to consult with First Nations, Métis and Inuit is an aspect of the process of fair dealing and reconciliation which flows from the historical relationship between the Crown and Aboriginal peoples. The federal Action Plan addresses the legal duty to consult with Aboriginal groups in a proper and timely manner when established or potential Aboriginal or Treaty rights may be adversely impacted. Duty to consult may be triggered by any proposed Government of Canada activity, including a federal approval, license, permit, project or activity that could adversely impact the rights outlined in the *Constitution Act, 1982*.

This legal duty to consult has resulted in increased Aboriginal engagement in project planning. It is becoming more important in regulatory framework. Aboriginal engagement should focus on the Aboriginal communities' experience, knowledge and current use of land for traditional activities. The planning of pipeline associated watercourse crossings may include discussions with Aboriginal communities' in regards to subsistence and recreational fishing, current or historical navigation, and cultural and traditional use.

2.2 Provincial and Territorial Jurisdictions

Each provincial and territorial jurisdiction has its own legislation, regulations, Codes of Practice, policies and/or guidelines affecting watercourse crossings. Provincial and territorial jurisdiction generally provides for the approval and regulation of the construction, operation and abandonment of oil and gas pipelines by provincially regulated proponents for a pipeline contained within the boundaries of one province. Interprovincial or international pipelines are regulated at a federal level under the NEB (see Section 2.1 of this document), but may still require provincial approval and need to follow provincial legislation.

Most provinces and territories require a permit, license and/or other authorization to use, affect or potentially affect, surface water and/or make alterations to stream beds and banks. The review of applications to alter stream beds and banks will involve the appropriate provincial fisheries management agencies and may include DFO depending on the agreement the province or territory has with DFO (see Section 2.1 of this document for more detail). Various conditions regarding construction schedule and techniques as well as required mitigative and restoration measures are usually appended to the approval document. The issuance of a permit or license generally does not exempt the applicant from the provision of any other applicable provincial or federal legislation, or any other processes of law including municipal by-laws.

The bed and banks of a watercourse are, in most instances, considered public lands in all provinces and territories in Canada. Proponents must apply to the appropriate provincial or territorial land agency for approval to cross these lands.

An overview of the regulatory requirements for each province and territory with regard to watercourse crossings is provided below. These requirements pertain to watercourse crossings only and it is assumed that the proponent will apply for any federal or provincial pipeline and/or oil and gas approvals required in addition to those listed above and below.

Aboriginal self-government, land claims and protocols are an ever-changing consideration in the approval processes. Documenting these requirements and recommendations are beyond the scope of this document. Nevertheless, to facilitate a timely review and approval, it is important that all proponents and regulators become familiar with the relevant agreements and other requirements. To ensure timely review and approval, it is beneficial that the appropriate applicable Aboriginal persons be consulted during the construction planning process.

2.2.1 Alberta

Alberta Environment and Sustainable Resource Development (AESRD), formerly Alberta Environment (AENV) and Alberta Sustainable Resource Development (ASRD), are the main provincial departments with responsibilities for pipeline associated watercourse crossings. There are currently three acts and their associated regulations and codes of practice under which a crossing may be regulated: (Note: Bill 2 was introduced on October 24, 2012 by the Government of Alberta and was enacted on December 10, 2012 as the *Responsible Energy Development Act* to establish a single energy regulator and create a new regulatory framework for energy resource projects in Alberta. It was not in force as of the date of this Fourth Edition but would encompass the following acts and regulations.)

- *Water Act*
 - Water Regulations
 - Codes of Practice
- *Environmental Protection and Enhancement Act*
 - Conservation and Reclamation Regulation
- *Public Lands Act*
 - Public Lands Pipeline Regulations

The *Water Act* and Ministerial Regulations allow for certain activities to be regulated by a Code of Practice. Currently there are two applicable Codes of Practice, *Code of Practice for Pipelines and Telecommunication Lines Crossing a Water Body* (AENV 2000a) and *Code of Practice for Watercourse Crossings* (e.g., culverts and bridges) (AENV 2000b). Projects that fall under these Codes of Practice do not require *Water Act* approval, however, the Director in the Regional

Area where the project is located must be given notice that a pipeline crossing(s) or watercourse crossing is going to be constructed.

The Codes of Practice set out engineering and aquatic environment protection standards that must be met for the construction of a pipeline or telecommunications line crossing a waterbody or watercourse crossing. The owner of the crossing must prepare a plan which includes specifications and written instructions as to when and how the crossing is to be constructed and that the standards of the Codes of Practice are met. There is a requirement that the engineering design for the pipeline or watercourse crossing be prepared by a professional engineer. To ensure that the aquatic environment is protected, any adverse impacts on the aquatic environment resulting from the construction of the crossing, must be fully mitigated. The proponent/owner must follow Schedule 1 of the Codes of Practice or have a qualified aquatic environment specialist prepare a plan that would ensure that the aquatic environment is protected. The Codes of Practice are accompanied by Management Area Maps covering the entire province. Recently, additional information has been released specifically on Class A watercourses in an overview and site maps collectively called the Atlas of Class A Watercourses Sites. Background information on the Codes of Practice and Management Area Maps can be obtained from AESRD.

Additional permits and approvals for pipeline associated watercourse crossings required under the *Environmental Protection and Enhancement Act* and the *Public Lands Act*, are discussed below.

Conservation and Reclamation (C&R) approval is required under the *Environmental Protection and Enhancement Act* for all Class 1 pipelines (pipeline index = mm O.D. x km $\geq 2,690$) in the White Area and requires proponents to submit a C&R report. Class 2 pipelines (pipeline index $< 2,690$) in the White Area do not require a C&R approval but are still subject to AESRD Guidelines (Alberta Environmental Protection [AEP] 1994a,b,c). As of May 30, 2011, an Environmental Field Report (EFR) is required for all pipelines on public land (White and Green Areas) with an index value greater than 2,690 (*i.e.*, Class 1 pipelines). Pipelines with an index value less than 2,690 on public land (White and Green Areas) (*i.e.*, Class 2 pipelines) must follow the Enhanced Approval Process (EAP).

Approval under the *Public Lands Act* is only required if public land is adjacent on both sides of the watercourse or if the proponent or AESRD requests an approval. To determine if an approval will be required and to obtain application forms, contact the AESRD Public Lands and Forest office nearest to the proposed activity.

Pipeline Agreements (PLAs) are required under the *Public Lands Act* to use Public land (*i.e.*, bed and banks of a watercourse).

Alberta has several provincial guidelines applicable to pipeline associated watercourse crossings:

- Fisheries Habitat Protection Guidelines
 - *Guideline 3 - Pipeline Construction and Stream Crossing* (Alberta Forestry, Lands and Wildlife 1987a)
 - *Guideline 4 - Vehicular Access Across Watercourses* (Alberta Forestry, Lands and Wildlife 1992a)
 - *Guideline 6 - Timing Constraints on Construction In and Around Watercourses* (Alberta Forestry, Lands and Wildlife 1992b)
 - *Guideline 7 - Timber Harvesting and Fish Habitat* (Alberta Forestry, Lands and Wildlife 1987b)
 - *Guideline 10 - Water Intakes: Screen Requirements for Fisheries* (Alberta Forestry, Lands and Wildlife 1993)
 - *Guideline 15 - Use of Explosives in the Water* (Alberta Forestry, Lands and Wildlife 1987c)
- *Stream Crossing Guidelines: Operational Guidelines for Industry* (Alberta Energy and Natural Resources 1985).
- *Design Guidelines and Application Procedures for a Bridge, Culvert or Other Structure Crossing a Watercourse or Waterbody* (Alberta Environment 1990).
- *Design Guidelines and Application Procedures for Buried Pipeline(s) Crossing a Watercourse or Waterbody* (AEP 1994a).
- *Environmental Protection Guidelines for Pipelines - C&R IL 94 5* (AEP 1994b).
- *Guide for Pipelines Pursuant to the Environmental Protection and Enhancement Act and Regulations* (AEP 1994c).
- *Conservation and Reclamation Guidelines for Alberta - C&R IL 97-1* (AEP 1997a).
- *Guidelines for the Application of Fish and Wildlife Conditions to Land Use Activities in Northeastern Slopes Region* (Draft) (AEP 1997b).
- *Guide to the Code of Practice for Pipelines and Telecommunication Lines Crossing a Water Body, Including Guidelines for Complying with the Code of Practice*. (AENV 2000c).
- *Guide to the Code of Practice for Watercourse Crossings, Including Guidelines for Complying with the Code of Practice*. (AENV 2000d).

As of December 1997, AESRD has no longer been actively participating in the federal regulatory processes involving fish habitat and navigable waters protection as they pertain to the *Fisheries Act* and the *NWPA*. Proponents are advised compliance with the Code of Practice or issuance of licences, authorizations and approvals by AESRD under the *Environmental Protection and Enhancement Act*, *Water Act* or the *Public Lands Act* does not mean the project has federal approval. If concerned about their project meeting the requirements of the *Fisheries Act*, proponents are encouraged to discuss their project with DFO.

2.2.2 British Columbia

In British Columbia (BC), the Ministry of Environment (MOE), the Ministry of Forests, Lands and Natural Resource Operations (MFLNRO) and the BC Oil and Gas Commission (OGC) are the main provincial regulating agencies for watercourse crossings. Watercourse crossings and water withdrawals for pipelines under NEB jurisdiction are subject to jurisdiction from the OGC as of April 2012. Several pieces of legislation which pertain to pipeline associated watercourse crossings are identified below:

- *Environmental Assessment Act*
 - Reviewable Projects Regulation, 2010
- *Oil and Gas Activities Act (OGAA) and the OGAA Environmental Protection and Management Regulation*
- *Fish Protection Act*
 - Riparian Areas Regulation, 2004
- *Forest Range And Practices Act Land Act*
- *Water Act*
 - Water Regulation, 2011
 - Pipelines are ‘reviewable’ under the *Environmental Assessment Act* by MOE if the construction of a new facility is a transmission pipeline in accordance with one of the following dimensions:<114.3 mm O.D., 60 km or more,
 - >114.3 and <323.9 mm O.D., 50 km or more,
 - >323.9 mm O.D., 40 km or more; or

The Minister may require other smaller projects to be reviewed under the *Environmental Assessment Act* if it is felt the project may have a significant adverse effect on the environment or if it is in the public interest to do so. The *Environmental Assessment Office Guide* (BC MOE 2009) provides details on what information requirements must be submitted on the application to MOE.

All provincially regulated oil and gas projects are reviewed by the BC Oil and Gas Commission. Proponents must complete consultation with government and stakeholders and submit an application form to the Commission. The Commission will then assess the project, conduct further consultation if required and provide a decision or approval for the project. If an environmental assessment is triggered under the *Environmental Assessment Act*, approval from MOE will be required prior to submitting the application to the BC Oil and Gas Commission.

The *Oil and Gas Activities Act* was implemented in October 2010 and is a consolidation of the *Oil and Gas Commission Act*, the *Pipeline Act* and the *Petroleum and Natural Gas Act*. This act updates and improves on BC's oil and gas regulatory framework and involved consultation with communities, local governments, Aboriginal communities, companies, landowners, environmental organizations and industry associations.

The *Fish Protection Act* provides for the protection of water flows for fish, designation of ‘sensitive streams’ requiring stronger management measures, protection of fish habitat and improved riparian protection. The Riparian Areas Regulation provides protection for riparian areas by ensuring that proposed activities are subject to a science-based assessment conducted by a Qualified Environmental Professional. Watercourse crossings will be subject to the *Fish Protection Act* and require compliance prior to the issuance of licenses and approvals by regional water managers.

Pipeline associated watercourse crossings require either approval from, or notification to BC MFLNRO under Section 9 of the *Water Act* and Part 7 of the Water Regulation. The *Water Act* has undergone some changes with respect to the *Fish Protection Act*. Fish habitat protection must be considered when applying for licenses under the *Water Act*. This includes adhering to timing windows to reduce risks to aquatic resources. Proponents are responsible for all debris entering a watercourse and must remediate or mitigate the effects of the introduction, as authorized by the regional water manager.

In BC, all watercourses are considered to be fish-bearing or have the potential to be fish-bearing unless proven otherwise (generally with at least two sampling seasons). Proponents must conduct a fisheries assessment for each watercourse crossing in which instream construction will take place. Fisheries assessments are also advised for bored or horizontal directionally drilled crossings where a contingency plan with instream construction will be initiated if drilling is not successful. Fisheries assessments must be conducted in accordance with recognized fish and fish habitat sampling methods and standards (Resources Inventory Committee (RIC) 1997, 1999, 2001; BC Ministry of Forests [MOF] 1998).

BC has several provincial codes of practices, guidelines and guides applicable to watercourse guidelines that are identified below:

- *Standards and Best Practices for Instream Works* (BC Ministry of Water, Land and Air Protection [MWLAP] 2004).
- *Stream Crossing Planning Guide* (Northeast BC) Version 2.0 – December 15, 2004 (BC Oil and Gas Commission 2004a).
- *Fish Stream Identification and Risk Management Tool* (BC Oil and Gas Commission 2004b).
- *Fish and Wildlife Timing Windows Document and Table* (BC Oil and Gas Commission 2004c).
- *Forest Practices Code of British Columbia: Fish-stream Crossing Guidebook* (BC MOF 2002a).
- *BC MFLNRO, BC MOE and DFO: Fish-stream Crossing Guidebook – Revised Edition* (BC MFLNRO et al. 2012)
- *Forest Practices Code of British Columbia: Riparian Management Area Guidebook* (BC MOF 1995).
- *Forest Road Engineering Guidebook* (BC MOF 2002b).

- *Environmental Protection and Management Guide* (BC Oil and Gas Commission 2011).
- *Environmental Assessment Office Guide* (BC MOE 2009).

DFO has developed *Land Development Guidelines for the Protection of Aquatic Habitat*, which are specifically designed for BC (DFO and BC MOE 1992). These guidelines pertain to the federal *Fisheries Act*.

2.2.3 Manitoba

The department of Conservation and Water Stewardship are the main regulatory agencies for watercourse crossings. There are five pieces of legislation noted below which pertain to pipeline associated watercourse crossings:

- *Environment Act*
- *Water Resources Administration Act*
- *Crown Lands Act*
- *Water Rights Act*
- *Water Protection Act*
 - Water Quality Standards, Objectives and Guidelines Regulation, 2011

A Manitoba *Environment Act* License is required for those projects that are likely to have a significant effect on the environment including construction and replacement of watercourse crossings. To acquire a license, an application must be submitted to the Environmental Assessment and Licensing Branch of Manitoba Conservation and Water Stewardship. Manitoba Conservation and Water Stewardship and other relevant federal and provincial departments will review the application. Fish and fish habitat protection measures are often included as conditions to the license for approved projects. Work permits may also be required under the *Environment Act* licenses and are used to ensure habitat is adequately protected in the manner described in the *Environment Act* License. Work permits are issued for a variety of activities including watercourse crossing installation and any activities which may alter the aquatic habitat.

Proponents of activities or developments which are to occur on, over or under Crown land must obtain a lease, general permit, easement or licence of occupation as required by *The Crown Lands Act*. This includes Crown lands under water. An application to carry out an activity or development affecting Crown land must be completed and returned to the Crown Lands and Property Agency of Manitoba Infrastructure and Transportation. The Crown Lands and Property Agency will undertake to circulate the application to relevant provincial government departments, Crown corporations and local government authorities for comment. Manitoba Conservation and Water Stewardship Lands Branch will review the comments received and either approve, conditionally approve or deny the application. The Lands Branch may, as part of the approval of the application, require the applicant to obtain a work permit issued in the region in which the activity or development is occurring. Work permits may be issued by a Manitoba Conservation Natural Resources Officer, Regional Director, Regional Supervisor

or Regional Land Manager. The Region is responsible for ensuring the conditions of the lease, permit, etc. and work permit are met. If the activity or development may adversely affect treaty or Aboriginal rights, the province may be required to undertake First Nation consultations prior to making a final decision on the application.

Under the *Water Resources Administration Act*, a proponent must obtain a permit to undertake instream or near shore construction in a designated river, stream or area (up to 107 m from the normal summer water mark). Deposition of any material that may impede or restrict the flow of water or affect bank stability as well as the construction of a structure that may affect bank stability is prohibited, unless authorized by issuance of a permit.

Under the *Water Rights Act*, a proponent must obtain a license to use or divert water in any matter, or to construct any works that may divert water. The permit or license application is made to the Regulatory and Operational Division, Manitoba Conservation and Water Stewardship. The Fisheries Branch also reviews the application and will provide recommendations based on fishery resources considerations.

The purpose of the *Water Protection Act* is to provide for the protection and stewardship of Manitoba's water resources and aquatic ecosystems, recognizing the following: that Manitoba's social and economic well-being is dependent upon the sustained existence of a sufficient supply of high quality water; the importance of comprehensive planning for watersheds, with respect to water, land and ecosystems, on a basis that acknowledges and considers their interdependence; that water resources and aquatic ecosystems require protection to ensure the high quality of drinking water sources; the importance of applying scientific information in decision-making processes about water, including the establishment of standards, objectives and guidelines; the need to protect riparian areas and wetlands; and, the benefits of providing financial incentives for activities that protect or enhance water, aquatic ecosystems or drinking water sources.

Guidelines for watercourse crossings were published by Manitoba Department of Natural Resources and DFO in 1996: *Manitoba Stream Crossing Guidelines for the Protection of Fish and Fish Habitat* (DFO and Manitoba Department of Natural Resources 1996).

Fish habitat management is coordinated between federal and provincial levels in Manitoba by a Memorandum of Understanding between Fisheries and Oceans Canada and Manitoba Conservation and Water Stewardship. The Memorandum of Understanding establishes the Canada/Manitoba Fish Habitat Committee that has the mandate of developing clear, concise and coordinated principles for fish habitat management by Canada and Manitoba.

2.2.4 New Brunswick

The New Brunswick Department of Natural Resources and Department of Environment administer most aspects of pipeline associated watercourse crossings. Crossings are subject to the following provincial legislation:

- *Clean Environment Act*
 - Environmental Impact Assessment Regulation
- *Clean Water Act*
 - Watercourse and Wetland Alteration Regulation
- *Crown Lands and Forest Act*

The approval and regulation of the construction and operation of oil and gas pipelines in New Brunswick are provided for by the Environmental Impact Assessment Regulation of the *Clean Environment Act*. All oil and gas pipelines exceeding 5 km in length are designated by this Regulation as projects which may result in significant environmental impact. These undertakings must be registered with the Department of Environment to determine whether the preparation of an environmental impact assessment is required.

DFO retains direct management control of fisheries in New Brunswick. However, a permit for a watercourse and wetland alteration may be required from the New Brunswick Department of Environment as legislated under the Watercourse and Wetland Alteration Regulation - *Clean Water Act*. The New Brunswick Department of Environment, Surface Water Protection Section will review the permit application and may request input from DFO and/or the New Brunswick Department of Natural Resources.

The New Brunswick Department of Natural Resources is responsible for the *Crown Lands and Forest Act*. Proponents must apply to receive an easement for a pipeline right-of-way on Crown lands including the bed and banks of a watercourse. All Crown Land applications involving a watercourse are referred to the Department of Environment for watercourse and wetland alteration permitting. Therefore the requirements under the *Clean Water Act* from the Department of Environment ensure compliance with the *Crown Lands and Forest Act* for pipeline associated watercourse crossings.

The New Brunswick Watercourse and Wetland Alteration Technical Committee is comprised of representatives from both provincial and federal government agencies and has prepared the Watercourse and Wetland Alteration Technical Guidelines (Province of New Brunswick Department of Environment, 2012).

2.2.5 Newfoundland and Labrador

The Newfoundland and Labrador Department of Environment and Conservation is responsible for the approval of pipeline associated watercourse crossings in Newfoundland and Labrador. Crossings are subject to the following legislation:

- *Environmental Protection Act*

- Environmental Assessment Regulations
- *Water Resources Act*

Pursuant to the Environmental Assessment Regulations of the *Environmental Protection Act*, oil and gas pipelines located a distance greater than 500 m from an existing right-of-way or located within 200 m of a federal *Fisheries Act* designated Salmon River must be registered and reviewed by the Minister of Environment and Conservation. An environmental preview report may be required to determine whether further environmental assessment is required or any significant adverse environmental impact is indicated. Alternatively, a proponent may proceed directly with the preparation of an environmental impact statement. Any alteration of a body of water, including a watercourse crossing, is an undertaking requiring approval under section 48 of the *Water Resources Act*. The approval must be obtained from the Department of Environment and Conservation, Water Resources Management Division and the application requires pertinent information relating to engineering, hydraulic design, site features, construction operations and anticipated engineering implications.

DFO retains direct management of fisheries of Newfoundland and Labrador. Authorizations may be required under the federal *Fisheries Act*.

2.2.6 Northwest Territories

Approval and regulation of oil and gas pipelines in the Northwest Territories (NWT) is administered by a number of different agencies and is dependent upon which region of the NWT the pipeline project will take place. The following descriptions illustrate the current regulatory environment in the NWT, but should not be considered prescriptive. Besides regional regulation, it is important to consider that overall the NEB administers, approves and regulates oil and gas pipelines and DFO retains direct management control of fisheries resources in the NWT.

Inuvialuit Settlement Region

The following legislation is relevant to the Inuvialuit Settlement Region (ISR):

- *Inuvialuit Final Agreement*
- *Territorial Lands Act*
 - Territorial Land Use Regulations, 2011
- *Northwest Territories Water Act*
 - Northwest Territories Water Regulations, 2011

In the ISR, the Inuvialuit Land Administration (ILA), is responsible for administering and managing the lands received under the Inuvialuit Final Agreement. All oil and gas applications involving use of Inuvialuit lands are filed with the ILA, which then forwards the applications to the Inuvialuit Environmental Impact Review Board for review and recommendations. Land use permits are granted by the ILA on Inuvialuit private lands and by AANDC on Crown lands according to Territorial Land Use Regulations of the *Territorial Lands Act*. The NWT Water Board issues all water licences according to the Northwest Territories Water Regulations within the ISR.

Mackenzie Valley

The following legislation is relevant to the Mackenzie Valley:

- *Mackenzie Valley Resource Management Act*
 - *Gwich'in Final Agreement*
 - *Sahtu Final Agreement*
 - *Tlicho Final Agreement*
 - Mackenzie Valley Land Use Regulations, 2011
- *Northwest Territories Water Act*
 - Northwest Territories Water Regulations, 2011

Developments in the Mackenzie Valley are subject to the regulatory regime established by the *Mackenzie Valley Resource Management Act*. The *Act* establishes regional land and water boards for the Gwich'in, Sahtu and Tlicho settlement areas for developments that will take place wholly within the settlement area boundaries. In addition, the *Act* designates the Mackenzie Valley Land and Water Board as the authority for unsettled claims areas and transboundary projects.

All land and water boards are responsible for the issuance of land use permits and water licences, both of which would be required for a watercourse crossing. Determination criteria for land use permits are set out in the Mackenzie Valley Land Use Regulations and water licences are issued pursuant to the Northwest Territories Water Regulations. If necessary, permit and license applications will be forwarded to the Mackenzie Valley Environmental Impact Review Board for environmental assessment and review.

2.2.7 Nova Scotia

DFO retains direct control of the fisheries of Nova Scotia. However, the Nova Scotia Government administers other provincial acts and regulations noted below.

- *Crown Lands Act*
- *Environment Act*
 - Activities Designation Regulations
 - Approvals Procedure Regulations
 - Environmental Assessment Regulations

The *Environment Act* requires that all projects altering a watercourse or its flow obtain a Water Approval for Watercourse Alteration from the Nova Scotia Department of Environment and Labour. Applications may be referred to other relevant provincial agencies or to DFO and TC for assessment. A blanket approval is available only for the installation of temporary bridges, single-span bridges and culverts. Proponents are required to take a Watercourse Alteration Certification training course and pass a certification exam to receive this blanket approval.

All onshore oil and gas pipelines greater than 5 km in length (with the exception of natural gas pipelines with an operating pressure less than 3450 kPa) require an Environmental Assessment from the Environmental Assessment Branch under the *Environment Act*. The Environmental Assessment information may be reviewed by other agencies such as DFO and Environment Canada and is made available for the general public to provide comments.

The Nova Scotia Department of Natural Resources is responsible for the *Crown Lands Act* and a right-of-way agreement must be obtained. The Water Approval for Watercourse Alteration from the Department of Environment ensures compliance with the *Crown Lands Act* for pipeline associated watercourse crossings.

2.2.8 Nunavut

Land use activities on Crown lands in Nunavut are regulated by many pieces of Federal and Territorial legislation including the Territorial Land Use Regulations of the *Territorial Lands Act*. Land use permit applications are submitted to AANDC who then forwards the application to the Nunavut Impact Review Board (NIRB). The NIRB was set up under Article 12 of the Nunavut Land Claim Agreement to examine potential development impacts for proposed projects. The NIRB may be required to assess the ecosystemic and socio-economic impacts of the project to determine whether the project should proceed to development and if so, under what conditions. Schedule 12-1 of the Nunavut Land Claims Agreement provides a list of activities that are exempt from screening by the NIRB. NIRB will forward the application to all interested parties for review. Interested parties include Federal/Territorial Regulatory agencies and Environmental Assessment Agencies, Nunavut Wildlife Management Boards, Nunavut Inuit Organizations, etc.

Land use activities on Inuit Owned Lands (IOL) are submitted to review by the the Nunavut Planning Commission (NPC). The NPC is responsible for ensuring projects conform to approved Land Use Plans (if one exists) and was set up under Article 11 of the Nunavut Land Claim Agreement.

Water license applications are submitted to the Nunavut Water Board (NWB) pursuant to the Nunavut Waters and Nunavut Surface Rights Tribunal Act. The NWB contributes fully to the assessment of development plans as they concern water in Nunavut and sets out the conditions in the Water licence issued. All water crossings and water uses or disposals of waste into water must be approved by the NWB. The NWB also collaborates with the NIRB and NPC in processing water license applications.

2.2.9 Ontario

Watercourse crossings in Ontario are administered by the Ontario Ministry of Natural Resources (OMNR) and Ontario Ministry of Environment (OMOE) in consultation with DFO and the Ontario Conservation Authority. Pipeline projects are subject to approval by the Ontario Energy Board which involves the preparation of an Environmental Report.

Pipeline associated watercourse crossings may require approval from the OMNR. If Crown lands are involved, the approval is issued in the form of a Work Permit under the *Public Lands Act* and if private or municipal lands are involved the permit is issued under the *Lakes and Rivers Improvement Act*. Pipeline associated watercourse crossings will require a Work Permit from OMNR in areas outside the jurisdiction of an Ontario Conservation Authority. Proponents should follow the procedures described in *Environmental Guidelines for Access Roads and Water Crossings* (OMNR 1990).

Approval from the OMNR is not required where the watercourse crossing is located within the jurisdiction of one of the 36 designated Conservation Authority Watersheds and falls under the *Lakes and Rivers Improvement Act* (*i.e.* on private or municipal lands). A permit can be obtained from the appropriate Conservation Authority on behalf of OMNR. The authority will issue a permit provided the construction of the crossing will not affect the control of flooding or pollution, or conservation of land. Work Permits for watercourse crossings under the *Public Lands Act*, and Easements for the watercourse crossing (*i.e.* on Crown lands) are issued by OMNR. Proponents are required to provide written information describing the proposed works to the local OMNR District Office in order to obtain written clarification on whether proposed works are subject to OMNR approval.

Trenchless crossings that do not include any work within the high water mark of a watercourse generally do not require an approval or Work Permit under the *Lakes and Rivers Improvement Act* or the *Public Lands Act*. However proponents should always seek confirmation from OMNR district offices on whether or not their particular project requires either a *Public Lands Act* or *Lakes and Rivers Improvement Act* approval prior to commencing any work. If the pipeline watercourse crossing is located within a Conservation Authority Watershed an approval may still be required if work is being done within the flood/erosion hazard limit. This can be clarified by the appropriate Conservation Authority.

Proponents should consult with OMOE to determine whether approval is required under the *Environmental Assessment Act*, *Environmental Protection Act* or *Ontario Water Resources Act*. A more detailed description of regulatory requirements and the referral process to conduct work in and around fish habitat is provided in *Fish Habitat Referral Protocol for Ontario* (OMNR 2009).

OMNR has developed generic drawings for dam/pump and flume crossing techniques and temporary access bridges. All open trenched crossing techniques will require a more extensive application and submission of a Sediment Control Plan. Information requirements for a Sediment Control Plan and copies of OMNR Generic Drawings can be obtained from OMNR offices.

Where applicable, Ontario Ministries may consult with local Aboriginal communities in their review and administration of watercourse crossing permit applications and approvals.

Listed below are several documents regarding guidelines and policies for pipeline associated watercourse crossings in Ontario:

- *Guidelines for Evaluating Construction Activities Impacting on Water Resources* (Ontario Ministry of Environment and Energy 1995).
- *Water Management - Goals, Policies, Guidelines, Objectives and Implementation Procedures of the Ministry of the Environment* (Ontario Ministry of the Environment 1984).
- *Ontario Generic Sediment Control Plans* (OMNR 1993a).
- *Sediment Control Plans for Wet Crossings* (OMNR 1993b).
- *Environmental Guidelines for Access Roads and Water Crossings* (OMNR 1990).
- *Environmental Guidelines for the Location, Construction and Operation of Hydrocarbon Pipelines and Facilities in Ontario* (Ontario Energy Board 2011).
- *Instream Sediment Control Techniques Field Implementation Manual* (Trow Consulting Engineers Ltd. 1996).
- *Fisheries-related Information Requirements for Pipeline Water Crossings* (Goodchild and Metikosh 1994).
- *Fish Habitat Referral Protocol for Ontario* (OMNR 2009).
- *Erosion and Sediment Control Guideline for Urban Construction* (Greater Golden Horseshoe Area Conservation Authorities 2006).

2.2.10 Prince Edward Island

Approval and regulation of pipeline associated watercourse crossings on Prince Edward Island (PEI) is administered by the PEI Department of Environment, Labour and Justice under the *Environmental Protection Act*. The proponent must provide an application for an Environmental Impact Assessment to the department with regard to the project. The Minister may request further information or ask the

proponent to develop an environmental impact statement, as well as provide public notification and input.

DFO retains direct management control of fisheries for PEI; however, a Watercourse, Wetland, and Buffer Zone Activity Permit is required from the PEI Department of Environment, Labour and Justice for all watercourse crossings. The review process for this permit includes comment from DFO. The Minister has appointed the PEI Watercourse Alteration Advisory Committee to review applications for watercourse alteration permits and to advise the Minister on these proposed projects. The Committee and DFO developed watercourse alteration guidelines in 1989 and have had various updates since then (PEI Watercourse Alterations Advisory Committee 1989). The guidelines were revised in 2006 to incorporate the measures outlined in the relevant DFO OSs. These guidelines are currently being updated to include buffer zones.

2.2.11 Québec

Watercourse crossings in Québec are subject to provisions under the *Loi sur la qualité de l'environnement* and the *Loi sur la conservation et la mise en valeur de la faune*.

Major pipeline associated watercourse crossings in Québec are subject to Articles 22 and 31.1 from the *Loi sur la qualité de l'environnement* and require an Environmental Impact Assessment as well as Public Hearings. Applications for major projects are submitted to la Direction des évaluations environnementales du ministère du Développement durable, de l'Environnement et des Parcs . Major projects are defined as one or both of the following:

- Construction of more than 2 km of new pipeline for the transportation of natural gas with a diameter of over 30 cm and pressure over 4000 kPa;
- Construction or reconstruction more than 2 km of electric line with a voltage of 315 kV or more;
- Involves dredging, digging, filling, leveling or backfilling of 300 m in length or larger or an area of 5,000 m² or more (up to the high water mark) in a 'river'; or
- Temporarily or permanently rerouting or diverting a 'river'.

Minor pipeline associated watercourse crossings in Québec are subject to Article 22 from the *Loi sur la qualité de l'environnement* and Article 128.7 of the *Loi sur la conservation et la mise en valeur de la faune*. Applications for authorization under article 22 of the *Loi sur la qualité de l'environnement* are submitted to the regional directors of the ministère du Développement durable, de l'Environnement et des parcs. Applications for authorization under Article 128.7 of the *Loi sur la conservation et la mise en valeur de la faune* can be submitted to either the regional director of the ministère des Ressources naturelles et de la Faune, or the ministère du Développement durable, de l'Environnement et des Parcs. However, if the project follows the regulations set out in the *Loi sur la conservation et la mise en valeur de la faune* then the proponent does not need to

obtain authorization from the ministère des Ressources naturelles et de la Faune. If the project occurs in a forested area, authorization under Article 3 of the *Loi sur les forêts* must also be obtained from the ministère des Ressources naturelles et de la Faune..

The ministère du Développement durable, de l'Environnement et des Parcs has outlined criteria under which projects are approved under the *Loi sur la qualité de l'environnement*. These criteria are published in a set of *fiches techniques* (fact sheets) that describe guidelines and regulations under the *Loi sur la qualité de l'environnement* and its application to proposed projects in Quebec, These technical bulletins include:

- Contrôle des plantes aquatiques et des algues (Control of aquatic plants and algae);
- Fiche technique sur la stabilisation des rives (Fact sheet on bank stabilization);
- Identification et delimitation des écosystèmes aquatiques, humides et riverains (Identification and delineation of aquatic ecosystems, wetlands and riparian areas);
- Stabilisation riveraine (Shoreline stabilization);
- Travaux en cours d'eau, bande riveraine et plaine inondable (in-stream, riparian and floodplain works); and
- Végétalisation de la bande riveraine (Shoreline revegetation).

2.2.12 Saskatchewan

Pipeline associated watercourse crossings in Saskatchewan are regulated by the Saskatchewan Ministry of Environment under the following legislation.

- *Environmental Assessment Act*
- *Environmental Management and Protection Act*
 - Water Regulations, 2002
- *Saskatchewan Watershed Authority Act*

The Saskatchewan Ministry of Environment requires proponents to apply for an Aquatic Habitat Protection Permit for all watercourse crossings under the *Environmental Management and Protection Act*. Proponents should contact the Senior Ecological Protection Specialist for the area in which the work is being undertaken. A map indicating the administrative areas for pipeline associated watercourse crossings is available from the Saskatchewan Ministry of Environment. A Saskatchewan Environmental Code is in the draft stage and will likely replace the Aquatic Habitat Protection Permit.

The Senior Ecological Protection Specialist will also advise whether the project is likely to require a review by the Environmental Assessment Branch regarding application of The *Environmental Assessment Act*.

The *Saskatchewan Watershed Authority Act* may be applicable to watercourse crossing involving the diversion of water. Proponents are advised to contact the Saskatchewan Watershed Authority to determine if a water rights license is required.

Several watercourse crossing guideline documents for Saskatchewan are identified below:

- *Fish Habitat Protection Guidelines: Road Construction and Stream Crossings* (Fisheries and Oceans Canada and Saskatchewan Environment and Resource Management 1995)
- *Environmental Operating Guidelines for the Saskatchewan Petroleum Industry* (Canadian Petroleum Association 1992).
- *Guidelines for Preparation of an Environmental Protection Plan for Oil and Gas Projects* (Saskatchewan Environment 2000).

2.2.13 Yukon

Approval and regulation of the construction and operation of oil and gas pipelines in the Yukon is administered by the Yukon government, Natural Resources Canada and the NEB. DFO has management control of marine and anadromous fisheries resources, and management of all fisheries habitat. The Yukon Fish and Wildlife Management Board and First Nation Renewable Resources Councils are responsible for non-anadromous fisheries and fulfill their responsibilities in consultation with DFO.

Watercourse crossings are subject to the following territorial legislation:

- *Yukon Environmental and Socio-economic Assessment Act (YESAA)*
 - YESAA Assessable Activities, Exceptions and Executive Committee Projects Regulations, 2005
- *Territorial Lands (Yukon) Act*
- *Waters Act*
 - Waters Regulations, 2003

The Development Assessment Process (DAP) established by the *Yukon Environmental and Socio-economic Assessment Act* was negotiated under the Yukon First Nations Umbrella Final Agreement and provides a comprehensive, integrated environmental assessment process that applies to First Nations settlement lands, Commissioner's (Territorial) lands and federal Crown lands. The YESAA Board (YESAB) and the Yukon Government Executive Council Office, DAP Branch oversee the administration of the *Act*. Generally, all oil and gas pipelines must be submitted to a Designated Office of the YESAB for an

environmental and socio-economic evaluation or screened by the Executive Committee.

The Yukon Water Board is responsible for the issuance of all water licences under the Waters Regulations of the *Waters Act*. A water license is required for any watercourse crossing that is 5 m wide or greater at the ordinary high water mark.

Land use permitting of land under the control of the Yukon government is conducted through the Department of Energy, Mines and Resources. Yukon First Nations have control over their individual settlement lands and must be contacted regarding proposed pipeline associated watercourse crossings within their jurisdiction. The Yukon Land Use Planning Council is in place to co-ordinate First Nation and government land use planning.

3 Description of Crossing Techniques

This section presents two tables summarizing the environmental and engineering/construction considerations for each type of pipeline and vehicle crossing technique. The intent is to help the reader to become aware of the advantages and disadvantages of each technique, and factor this information into the watercourse crossing planning process. Several pathways of effects (POE) models have been developed for in-water activities and land-based activities associated with the considerations listed in these two tables. Refer to DFO's website for the activities in which POE models have been developed.

3.1 Pipeline Crossings

This subsection outlines the various pipeline watercourse crossing construction techniques commonly used in Canada. Table 3.1 summarizes the environmental and construction advantages and disadvantages as well as the appropriate uses of each crossing method of construction. Drawings 1 to 11 (see Appendix A) outline the standard protection measures that should be incorporated with each technique. Although the appropriate uses for each technique are identified, implementation of alternative techniques with mitigation measures or a combination of techniques may also be applicable. Since the drawings and measures contained in this document are typical and not site-specific, detailed design drawings might be required with input from an engineer and other specialists.

3.2 Temporary Vehicle Crossings

This subsection outlines the various vehicle crossing techniques that are commonly used during the construction of pipeline associated crossings. Table 3.2 summarizes the environmental and construction advantages and disadvantages as well as the appropriate uses of each technique. Drawings 12 to 15 (see Appendix A) illustrate the more common techniques and outline the standard environmental protection measures that should be implemented with each crossing method. Typical vehicle crossing drawings should be designed by an engineer with input from other specialists to meet regulatory requirements. In many situations, typical drawings similar to those contained in this document will be sufficient; however, where site-specific cases warrant, or where special vehicle crossing techniques are necessary, individual crossing designs by an engineer should be considered.

Table 3.1 Pipeline Watercourse Crossing Construction Techniques

Description	Environmental Considerations		Construction / Engineering Considerations		Comments
	Advantages	Disadvantages	Advantages	Disadvantages	
OPEN TRENCHED i) Plow (see Dwg. 1)					
<ul style="list-style-type: none"> • plow-in pipeline without pretrenching • feed or drag pipeline into furrow behind plow 	<ul style="list-style-type: none"> • rapid construction / installation • minimizes period of instream activity • minimizes total sediment release • short period of sediment release • minimal temporary workspace required 	<ul style="list-style-type: none"> • grading of banks required • potential sediment release during grading of banks • sediment release during instream work • removal of riparian vegetation 	<ul style="list-style-type: none"> • reduces instream activity • eliminates backfilling phase • low cost if equipment onsite • rapid construction / installation 	<ul style="list-style-type: none"> • specialized equipment • need access ramps to creek • problematic in boulders and bedrock • depth of cover is limited 	<ul style="list-style-type: none"> • unconsolidated substrate (e.g., sand or gravel) • shallow lakes or watercourses with little or no flow (<1 m deep) • when pipeline on uplands is also being plowed-in • small diameter pipelines (<168.3 mm O.D.) • where instream work is permitted but sediment release is to be minimized
OPEN TRENCHED ii) Bucket / Wheel Trencher					
<ul style="list-style-type: none"> • trench through watercourse with bucket / wheel trencher 	<ul style="list-style-type: none"> • rapid construction / installation • minimizes period of instream activity • short period of sediment release 	<ul style="list-style-type: none"> • potentially high sediment release • spoil pile may block flow • trench is prone to sloughing • requires extensive grading of banks 	<ul style="list-style-type: none"> • no special equipment • not limited by width of watercourse • low cost • rapid construction / installation 	<ul style="list-style-type: none"> • limited by water depth (<1 m) • trench is prone to sloughing • trench may not be wide enough • equipment has trouble on steep banks • difficulty with rocky substrate or bedrock • trench depth may be inadequate 	<ul style="list-style-type: none"> • dry intermittent watercourses with fine-textured substrate where wheel ditcher is being used on uplands • possibly for low flow, low sensitivity streams with low banks • dry creeks and shallow swales

Table 3.1 Pipeline Watercourse Crossing Construction Techniques, Cont'd

Description	Environmental Considerations		Construction / Engineering Considerations		Comments
	Advantages	Disadvantages	Advantages	Disadvantages	
OPEN TRENCHED iii) Hoe (see Dwgs. 2 and 3)					
<ul style="list-style-type: none"> trench through watercourse with hoe from banks or instream 	<ul style="list-style-type: none"> rapid construction / installation minimizes period of instream activity generally maintains streamflow maintains fish passage relatively short duration of sediment release (<24 hours) 	<ul style="list-style-type: none"> potentially high sediment release during excavation and backfilling instream stockpiling of spoil on wide watercourses may interrupt streamflow 	<ul style="list-style-type: none"> no need for specialized equipment rapid construction / installation low cost compatible with granular substrates and some rock 	<ul style="list-style-type: none"> limited to channel width of less than 20 m unless hoe works instream limited by water depth unless hoe works off barge may require several hoes working together to facilitate excavation 	<ul style="list-style-type: none"> shallow (<1.5 m) watercourse with unconsolidated granular substrate
OPEN TRENCHED iv) Dragline (see Dwg. 4)					
<ul style="list-style-type: none"> trench through watercourse with dragline bucket from either bank 	<ul style="list-style-type: none"> equipment not in watercourse spoil on banks maintains streamflow maintains fish passage 	<ul style="list-style-type: none"> potentially high sediment release slow construction / installation long duration of sediment release safety concern with cables strung across watercourse may require grading of banks leading to sediment release large area required for equipment 	<ul style="list-style-type: none"> permits many passes over trench cleans sloughed material from trench good for unconsolidated substrate permits deeper trench 	<ul style="list-style-type: none"> moderately expensive inaccurate control on trench width and alignment slow construction / installation specialized equipment trench susceptible to sloughing need large working space for equipment set up cables restrict navigational use of watercourse incompatible with boulders or consolidated bottom material 	<ul style="list-style-type: none"> wide and deep watercourses with soft substrate and limited navigational concerns often used to clean out trench initiated with hoes

Table 3.1 Pipeline Watercourse Crossing Construction Techniques, Cont'd

Description	Environmental Considerations		Construction / Engineering Considerations		Comments
	Advantages	Disadvantages	Advantages	Disadvantages	
OPEN TRENCHED v) Dredging					
<ul style="list-style-type: none"> dredge trench through watercourse with suction and pump slurry to banks or tanks on barges 	<ul style="list-style-type: none"> minimal sediment release during trenching maintains streamflow maintains fish passage no instream spoil storage relies on natural sediment transport for backfill 	<ul style="list-style-type: none"> settling ponds required for slurry disposal of settled water possible mortality or injury to fish 	<ul style="list-style-type: none"> allows deep water trenching technique for transporting to shore no instream spoil storage 	<ul style="list-style-type: none"> expensive specialized equipment settling pond must be constructed difficult in large granular substrate or bedrock trench depth may be inadequate 	<ul style="list-style-type: none"> deep, wide rivers / lakes with fine unconsolidated substrate where sediment release is a concern
ISOLATED TRENCHED i) Flume (see Dwg. 5)					
<ul style="list-style-type: none"> block flow upstream of crossing and divert through flume pipe(s) laid in streambed perpendicular to pipeline dam downstream side of crossing area to prevent backflow flume(s) should be properly sized to accommodate flow high capacity variations (e.g., 'super flume') constructed out of 2 m x 3 m x 32 m steel box sections may be augmented with pump bypass 	<ul style="list-style-type: none"> limited sediment release maintains streamflow may allow fish passage minimal release and transport of sediment downstream; not likely to result in negative effects to fish and fish habitat. allows for flushing of substrates 	<ul style="list-style-type: none"> minor sediment release during dam construction, removal and as water flushes over area of construction slow construction / installation prolongs sediment release fish salvage may be required from dried up reach short-term barrier fish passage if water velocity in culvert is too high 	<ul style="list-style-type: none"> relatively dry or no flow working conditions ample time for pipeline construction may be adapted for nonideal conditions compatible with consolidated substrates may incorporate bridge may reduce ditch sloughing and ditch width 	<ul style="list-style-type: none"> difficult to trench and lay pipe, especially large diameter pipe, under flume pipe difficult to install properly flow limited by flume size 2 - 3 m³/s using multiple flume pipes or 'super flume' >20 m³/s moderately expensive work area may not stay dry in coarse, permeable substrate too short a flume may not be sufficient for unstable trench flume pipe can be crushed or blocked during pipeline construction requires relatively long, straight channel to install flume 	<ul style="list-style-type: none"> small watercourse with defined banks and defined channel with solid, fine-textured straight substrate where sediment release and fish passage are of concern works best in nonpermeable substrate common usage is for flows <1 m³/s

Table 3.1 Pipeline Watercourse Crossing Construction Techniques, Cont'd

Description	Environmental Considerations		Construction / Engineering Considerations		Comments
	Advantages	Disadvantages	Advantages	Disadvantages	
ISOLATED TRENCHED ii) Dam and Pump (See Dwg. 6)					
<ul style="list-style-type: none"> dam flow upstream and downstream of crossing and pump water around via hose(s) 	<ul style="list-style-type: none"> limited sediment release maintains streamflow minimal release and transport of sediment downstream; not likely to result in negative effects to fish and fish habitat. 	<ul style="list-style-type: none"> minor sediment release during dam construction, dam removal and as water flushes over area of construction slow construction / installation resulting in extended period instream and prolonged sediment release fish salvage may be required from dried up reach short-term barrier to fish movement 	<ul style="list-style-type: none"> relatively dry working conditions ample time for pipeline construction may be adapted for nonideal conditions hose can be routed around area of construction multiple pumps can be used compatible with consolidated substrates can be used in watercourses with meandering channel may reduce ditch sloughing and ditch width 	<ul style="list-style-type: none"> size of watercourse limited to pump capacity specialized equipment and materials slow construction / installation moderately expensive hose(s) may impede construction traffic seepage may occur in coarse, permeable substrate susceptible to mechanical failure requires standby pump(s) 	<ul style="list-style-type: none"> small watercourse with low flow, defined banks and channel with no requirement for fish passage where sediment release is of concern works best in non-permeable substrate common usage is for flows <1 m³/s (max. capacity of 1 pump ~0.3 m³/s)

Table 3.1 Pipeline Watercourse Crossing Construction Techniques, Cont'd

Description	Environmental Considerations		Construction / Engineering Considerations		Comments
	Advantages	Disadvantages	Advantages	Disadvantages	
ISOLATED TRENCHED iii) High Volume Pump Bypass / Sump and Pump (See Dwg. 7)					
<ul style="list-style-type: none"> install high volume pump(s) bypass in pool upstream of crossing and pump watercourse dry, discharging downstream of crossing construct work area sump downstream of ditch to permit 'washing' of work area pump silt-laden water from sump onto well vegetated area partial bypass in high flow situations may be used to reduce instream water velocity 	<ul style="list-style-type: none"> limited sediment release maintains streamflow normal streamflow can be restored instantly no sediment release as a result of dam construction minimal release and transport of sediment downstream; not likely to result in negative effects to fish and fish habitat. 	<ul style="list-style-type: none"> minor sediment release as water flushes over area after construction dries up short reach of streambed short-term barrier to fish movement fish salvage may be required from dried up areas sump areas are required 	<ul style="list-style-type: none"> no dams are required flow can be regulated if necessary hose(s) can be routed around area of construction multiple pumps can be used compatibility with consolidated substrates 	<ul style="list-style-type: none"> sump(s) may need to be excavated specialized equipment and materials required moderately expensive hose(s) may impede construction traffic requires stand-by pump(s) susceptible to mechanical failure 	<ul style="list-style-type: none"> small to moderate watercourses with low to moderate flow (1 m³/s) and no requirement for fish passage (max. pump capacity ~0.3 m³/s) partial bypass in high flow situations may be used to reduce instream water velocity

Table 3.1 Pipeline Watercourse Crossing Construction Techniques, Cont'd

Description	Environmental Considerations		Construction / Engineering Considerations		Comments
	Advantages	Disadvantages	Advantages	Disadvantages	
ISOLATED TRENCHED iv) Cofferdam (see Dwg. 8)					
<ul style="list-style-type: none"> install dam approximately 2/3 into watercourse surrounding work area pump area dry or work in 'still' waters remove dam and repeat on other side of watercourse materials such as regular sandbags, sheet piling, oversized (1 m³) sandbags, rock fill / median barriers, poly water structures or a combination of the above can be used 	<ul style="list-style-type: none"> maintains streamflow maintains fish passage minimal release and transport of sediment downstream; not likely to result in negative effects to fish and fish habitat. 	<ul style="list-style-type: none"> moderate sediment release based on amount of instream work may dry up long reach of watercourse fish salvage required from dried-up reach increased water velocity and potential scouring possible increased erosion on opposite bank potential washout of dam slow construction / installation extensive instream activity with heavy equipment may be required to install dams requires large right-of-way and terrain disturbance 	<ul style="list-style-type: none"> relatively dry or no flow working environment ample time for pipeline construction compatible with consolidated substrates 	<ul style="list-style-type: none"> source of dam materials needed (i.e., sandbags, rock fill, poly, etc.) pumping may be required expensive specialized materials difficult to make tie-in slow construction / installation potential washout of dam safety concerns 	<ul style="list-style-type: none"> moderate to large watercourses too large for flume or pump techniques where sediment release and fish passage are of concern braided stream channels watercourses with low banks where an extended instream period is required isolation of stream banks or portions of streambeds for maintenance and repair works

Table 3.1 Pipeline Watercourse Crossing Construction Techniques, Cont'd

Description	Environmental Considerations		Construction / Engineering Considerations		Comments
	Advantages	Disadvantages	Advantages	Disadvantages	
ISOLATED TRENCHED v) Channel Diversion (see Dwg. 9)					
<ul style="list-style-type: none"> divert streamflow into existing side channels or abandoned channel or construct a new channel use rockfill, sheet piling or poly water structures to divert flow channel may be lined or have a flexible stream diversion conduit installed 	<ul style="list-style-type: none"> maintains streamflow maintains fish passage minimal release and transport of sediment downstream; not likely to result in negative effects to fish and fish habitat. 	<ul style="list-style-type: none"> unless lined, very high sediment release when new channel is flushed through dries up long reach of watercourse fish salvage required from dried-up reach slow construction / installation potential washout of diversion dam damage to streambank and adjacent lands 	<ul style="list-style-type: none"> relatively dry working area ample time for pipeline construction compatible with consolidated substrates 	<ul style="list-style-type: none"> expensive source of dam (<i>i.e.</i>, sandbags, rock fill, poly, etc.) material needed may require channel liner or conduit may require extensive preparation and channel grading / restoration specialized materials required slow construction / installation potential washout of diversion dam 	<ul style="list-style-type: none"> watercourses too large to flume or pump best used when new channel is clear of fine substrate and will cause little sediment release braided stream channels where sediment release and fish passage are of concern

Table 3.1 Pipeline Watercourse Crossing Construction Techniques, Cont'd

Description	Environmental Considerations		Construction / Engineering Considerations		Comments
	Advantages	Disadvantages	Advantages	Disadvantages	
TRENCHLESS i) Boring (see Dwg. 10)					
<ul style="list-style-type: none"> • bore under water-course from bellhole on one side to bellhole on other with or without casing • wet boring with pilot hole and reaming bit can also be performed 	<ul style="list-style-type: none"> • no sediment release • no disturbance of streambed or banks • maintains normal streamflow • maintains fish passage • maintains vegetative buffer on either side of watercourse • not likely to result in HADD 	<ul style="list-style-type: none"> • pump(s) may be required to drain seepage within the bellholes onto surrounding lands • possibility of sump water causing sediment release in watercourse • requires additional workspace for bellholes, spoil piles and sump(s) • potential for borehole cave-in and/or dewatering 	<ul style="list-style-type: none"> • can be fast and economical under the right conditions • minimizes clean-up of bed and banks • road boring equipment may be available • may be able to construct during sensitive fisheries restricted activity windows 	<ul style="list-style-type: none"> • can be slow or not feasible under adverse conditions • difficult with till or coarse material • potential for borehole cave-in • excessive borehole depth on deeply incised watercourses or watercourses with moderate or greater approach slopes • with excessive seepage in course fluvial material it may be impossible to keep bell hole dry • seepage into bellhole may cause sloughing • possible need for specialized equipment and pump(s) • length limited to approximately 100 m, however, length varies with borehole diameter 	<ul style="list-style-type: none"> • fine-textured impermeable soils • low water table • where streambed cannot be disturbed • used most often on irrigation ditches • where fish / riparian habitat cannot be disturbed • where the watercourse is only slightly incised and approach slopes are absent or slight

Table 3.1 Pipeline Watercourse Crossing Construction Techniques, Cont'd

Description	Environmental Considerations		Construction / Engineering Considerations		Comments
	Advantages	Disadvantages	Advantages	Disadvantages	
TRENCHLESS ii) Punching / Ramming (see Dwg. 10)					
<ul style="list-style-type: none"> ram or punch casing or pipe under watercourse 	<ul style="list-style-type: none"> no sediment release no disturbance of streambed and banks maintains normal streamflow maintains fish passage maintains vegetative buffer on both sides of watercourse not likely to result in HADD 	<ul style="list-style-type: none"> pump(s) may be required to drain seepage within the bellholes onto surrounding lands possibility of sump water causing sediment release in watercourse requires additional workspace for bellholes, spoil piles and sump(s) ground vibrations and associated pressure waves could be an issue during sensitive life history phases for fish 	<ul style="list-style-type: none"> can be quick under the right conditions avoids clean-up of bed and banks cave-ins of borehole are unlikely larger pipe diameters can be accommodated may be able to construct during sensitive fisheries restricted activity windows 	<ul style="list-style-type: none"> can be slow under adverse conditions potential bellhole cave-in ahead of ram seepage into bellhole with excessive seepage in course fluvial material it may be impossible to keep hole dry specialized equipment may be required potential corrosion problems from coating stripping relatively inaccurate limited to ~50 m in length excessive borehole depth on deeply incised watercourses or watercourses with moderate or greater approach slopes 	<ul style="list-style-type: none"> fine-textured impermeable soils low water table irrigation ditches where streambed cannot be disturbed can also be used in coarse-textured substrate narrow to moderate watercourse (<i>i.e.</i>, <30 m) where the watercourse is only slightly incised and approach slopes are absent or slight

Table 3.1 Pipeline Watercourse Crossing Construction Techniques, Cont'd

Description	Environmental Considerations		Construction / Engineering Considerations		Comments
	Advantages	Disadvantages	Advantages	Disadvantages	
TRENCHLESS iii) Horizontal Directional Drilling (see Dwg. 11)					
<ul style="list-style-type: none"> • slant drill used to drill under watercourse and, where practical, approach slopes 	<ul style="list-style-type: none"> • no sediment release unless frac-out occurs • no bank disturbance • no streambed disturbance • may avoid approach slope disturbance • maintains normal streamflow • maintains fish passage • not likely to result in HADD • maintains vegetation buffer on both sides of watercourse 	<ul style="list-style-type: none"> • disturbance of drilling and target area • disposal of drilling fluids • fractures in substrate may release pressurized drilling fluids into watercourse • circulating drilling fluid may wash out cavities under the watercourse and banks resulting in sinkholes • possible spills from drilling sump(s) down towards watercourse • large area may be required on floodplains 	<ul style="list-style-type: none"> • eliminates clean-up and reclamation in between entry and exit points • avoids work in repairing and restoring banks • reduction in reclamation costs • reduction of long-term maintenance • may be able to construct during sensitive fisheries restricted activity windows • small diameter pipelines successfully drilled across sensitive watercourses or up steep slopes can be cost effective by reducing habitat compensation and reclamation costs 	<ul style="list-style-type: none"> • moderately to very expensive • success depends on substrate • specialized equipment • slow construction / installation • limited to arc that can be drilled for pilot hole (10-20° entry / exit angles) • limited arc that pipe can 'rope' through the hole, especially large diameter pipe • may take several attempts • drill stem may get 'stuck in the hole' and tools can get lost, especially on large diameter reams • no guarantees that drill will be successful • may damage coating / pipe 	<ul style="list-style-type: none"> • watercourse with sensitive habitat where no instream activity allowed • watercourses where HADD may result from instream activity • areas with very unstable approach slopes • high aesthetic concerns (<i>i.e.</i>, parks) • restrict HDD staging in the floodplain, where conditions allow.

Table 3.1 Pipeline Watercourse Crossing Construction Techniques, Cont'd

Description	Environmental Considerations		Construction / Engineering Considerations		Comments
	Advantages	Disadvantages	Advantages	Disadvantages	
TRENCHLESS iv) Micro-tunneling					
<ul style="list-style-type: none"> use a small tunnel boring machine to create a tunnel for the pipe or casing 	<ul style="list-style-type: none"> no sediment release no bank disturbance no streambed disturbance no approach slope disturbance maintains normal streamflow maintains fish passage not likely to result in HADD 	<ul style="list-style-type: none"> tunnel spoil / slurry requires large areas disposal of tunnel spoil large space requirements on flood plains 	<ul style="list-style-type: none"> can be utilized in most substrates above or below the water table eliminates clean-up and reclamation in streambed and banks may be able to construct during sensitive fisheries restricted activity windows 	<ul style="list-style-type: none"> special equipment and crew are required limited by length of pipe to be pushed and the friction forces imposed high cost may require detailed engineering tunnel spoil / slurry may require removal or settling tanks and water treatment if chemical lubricants were used 	<ul style="list-style-type: none"> large diameter pipelines crossings with ample room for tunnel spoil storage and bellholes high aesthetic concerns (i.e., parks)
AERIAL i) Bridge Attachment					
<ul style="list-style-type: none"> attach pipeline to existing bridge structure 	<ul style="list-style-type: none"> no sediment release no bank disturbance no streambed disturbance maintains normal streamflow maintains fish passage not likely to result in HADD 	<ul style="list-style-type: none"> possible visual impact safety and potential introduction of product into watercourse due to third party damage potential introduction of paint and cleaning products into watercourse during future maintenance 	<ul style="list-style-type: none"> reduces clean-up and reclamation of bed and banks 	<ul style="list-style-type: none"> potentially expensive depends on bridge design specialized crew and equipment slow construction / installation potential for third party damage regulatory approval may be delayed or denied ongoing maintenance required 	<ul style="list-style-type: none"> large watercourse with sensitive habitat where no instream activity is allowed areas with very unstable approach slopes high aesthetic concerns (e.g., parks) where an existing bridge has been built deep gorges / canyons urban areas where bridges are abundant

Table 3.1 Pipeline Watercourse Crossing Construction Techniques, Cont'd

Description	Environmental Considerations		Construction / Engineering Considerations		Comments
	Advantages	Disadvantages	Advantages	Disadvantages	
AERIAL ii) Self-Supporting Clear Span Bridge					
<ul style="list-style-type: none"> construct bridge or abutments to carry pipeline 	<ul style="list-style-type: none"> no sediment release no streambed disturbance no bank disturbance maintains normal streamflow maintains fish passage not likely to result in HADD 	<ul style="list-style-type: none"> visual impact safety and introduction of product into watercourse due to third party damage instream construction required for bridge abutments may trigger additional regulatory review may require removal of potential danger trees within riparian zone to maintain integrity 	<ul style="list-style-type: none"> reduces clean-up and reclamation of streambed and banks 	<ul style="list-style-type: none"> very expensive specialized crew and equipment slow construction / installation potential for third party damage regulatory approval may be delayed or denied ongoing maintenance required requires design to meet <i>Navigable Waters Protection Act</i> requirements 	<ul style="list-style-type: none"> large watercourse with sensitive habitat where no instream activity is allowed areas with very unstable approach slopes deep gorges / canyons

Table 3.2 Temporary Vehicle Watercourse Crossing Techniques

Description	Environmental Considerations		Construction / Engineering Considerations		Comments
	Advantages	Disadvantages	Advantages	Disadvantages	
EXISTING BRIDGE					
<ul style="list-style-type: none"> utilize existing bridge off right-of-way for access across watercourse 	<ul style="list-style-type: none"> no instream disturbance no bank disturbance no approach slope disturbance maintains regular streamflow maintains fish passage 	<ul style="list-style-type: none"> terrestrial disturbance caused by access to and from right-of-way via shoo-flies 	<ul style="list-style-type: none"> limited construction costs weight limit probably not an issue 	<ul style="list-style-type: none"> inefficient to drive around complications of shuttling equipment may slow process of construction 	<ul style="list-style-type: none"> where trenchless crossing methods are used where crossings are near bridges on larger rivers where other methods are not feasible where sediment release is of concern where streamflow and fish passage must be maintained
TEMPORARY BRIDGE (see Dwg. 12)					
<ul style="list-style-type: none"> construct temporary bridge with native timber or import portable bridge 	<ul style="list-style-type: none"> limited stream disturbance limited sediment release maintains streamflow maintains fish passage 	<ul style="list-style-type: none"> possible bank and approach slope disturbance sediment release if bank abutments are built to support bridge cap over timber bridge may cause sediment release in watercourse may interfere with navigable use of waterway sediment mobilization from scour if instream abutments are used for multiple bridge spans 	<ul style="list-style-type: none"> strong removable reusable (portable) can be located at optimal location 	<ul style="list-style-type: none"> may entail a substantial amount of work to transport or construct bridge moderate costs specialized equipment / crew timber bridge may require cap timber bridge span is limited regular maintenance and repair of erosion and sediment controls required 	<ul style="list-style-type: none"> small to moderate size watercourses with stable banks larger watercourses may be crossed with multiple bridge spans and instream abutments bridge must be maintained

Table 3.2 Temporary Vehicle Watercourse Crossing Techniques, Cont'd

Description	Environmental Considerations		Construction / Engineering Considerations		Comments
	Advantages	Disadvantages	Advantages	Disadvantages	
ICE BRIDGE (see Dwg. 13)					
<ul style="list-style-type: none"> construct bridge over ice on watercourse remove snow and flood to strengthen if warranted 	<ul style="list-style-type: none"> limited sediment release maintains streamflow maintains fish passage 	<ul style="list-style-type: none"> susceptible to winter thaw grading of banks and approach may be necessary potential safety hazard possible depression of ice and blockage of flow and fish passage in shallow watercourse contamination of watercourse may result during thaw 	<ul style="list-style-type: none"> can be easily constructed where needed 	<ul style="list-style-type: none"> slow to construct limited to freezing conditions potential for thawing safety concerns ice must be >0.5 m thick contingency required for thawing conditions logs may be required for reinforcement moderately expensive must be maintained free of soil 	<ul style="list-style-type: none"> moderate to large sized watercourses with low approach slopes and banks location where ice is thick and solid relatively low velocity and deep watercourses where sediment release is of concern where streamflow and fish passage must be maintained winter projects
SWAMP MATS					
<ul style="list-style-type: none"> cabled logs, timbers or prefabricated steel pipes or rails in the form of a mat or grid tie enough mats together to form crossing 	<ul style="list-style-type: none"> minimizes sediment release mat surface less likely to embed into substrate clean removal generally maintains streamflow can be used to span very narrow watercourses can be used to protect banks where bridge spans are secured 	<ul style="list-style-type: none"> possible grading of banks required could restrict flow and fish passage if watercourse is too shallow introduction of wood/bark into streambed 	<ul style="list-style-type: none"> easy to install easy to construct easy to remove portable low cost, local materials not prone to freezing into substrate 	<ul style="list-style-type: none"> logs deteriorate and break up with extensive use susceptible to washout not as stable as some other crossings has to be shallow crossing <0.3 m safety concerns due to instability 	<ul style="list-style-type: none"> small to moderate size shallow watercourse where disruption of substrate is a concern and ease of removal is important where fish passage, streamflow and sediment release are not a concern

Table 3.2 Temporary Vehicle Watercourse Crossing Techniques, Cont'd

Description	Environmental Considerations		Construction / Engineering Considerations		Comments
	Advantages	Disadvantages	Advantages	Disadvantages	
LOG / PIPE FILL					
<ul style="list-style-type: none"> • cable logs or pipes together and fill in channel • cap of snow often used • cable is wrapped around logs or pipes to ease removal 	<ul style="list-style-type: none"> • limited sediment release • pipes maintain flow and may maintain fish passage if installed correctly • clean removal on solid substrate 	<ul style="list-style-type: none"> • can sink into substrate • if they freeze in place, are hard to remove and may impede flow during spring run off • difficult removal may increase effects on bed and banks • small logs may block flow and fish passage 	<ul style="list-style-type: none"> • low cost, local materials • easy to install • easy to construct • easy to remove when not frozen 	<ul style="list-style-type: none"> • will freeze in during winter • difficult to remove • cap may be necessary and difficult to remove • prone to deterioration and break-up 	<ul style="list-style-type: none"> • small steep banked creeks • may be used like corduroy on shallower creeks • where fish passage and flow are not a concern
SNOW FILL					
<ul style="list-style-type: none"> • plow clean snow into creek channel and pack • logs may be used for reinforcement 	<ul style="list-style-type: none"> • limited sediment release • minimizes bank disturbance 	<ul style="list-style-type: none"> • introduction of soil into snowfill may lead to sediment release during spring break-up • some deterioration of banks may occur • may block flow and fish passage if no ice in watercourse 	<ul style="list-style-type: none"> • low cost • easy to construct • easy to remove • use of local material • only have to be notched open rather than removed to facilitate flow during spring run off 	<ul style="list-style-type: none"> • deteriorates with use • high maintenance • susceptible to thaw • logs may be needed for reinforcement • must be removed prior to spring break-up 	<ul style="list-style-type: none"> • small watercourse in winter where fish passage and streamflow are not a concern • most appropriate for small intermittent drainages • winter project • not practical when snow depth is limited
RAMP AND CULVERT / FLUME (see Dwg. 14)					
<ul style="list-style-type: none"> • divert flow through culvert laid perpendicular to pipeline • use steel pipe not galvanized culvert for flume • build ramp over top 	<ul style="list-style-type: none"> • limited sediment release • maintains stream flow and fish passage • bottomless arch culverts can be used where fish habitat/passage is a concern 	<ul style="list-style-type: none"> • sediment release when filling around culvert and removing culvert • susceptible to washout • icing in winter may block flow and fish passage • may require bank grading 	<ul style="list-style-type: none"> • when used in combination with flume construction technique, flume replaces culvert • forms one dam for dam and pump 	<ul style="list-style-type: none"> • heavy traffic may crush culvert • susceptible to washout • may require specialized materials such as sandbags and select fill 	<ul style="list-style-type: none"> • small to moderate sized watercourses with or without flow • where streamflow and fish passage are of concern • not as commonly used • watercourses with defined channel and banks

Table 3.2 Temporary Vehicle Watercourse Crossing Techniques, Cont'd

Description	Environmental Considerations		Construction / Engineering Considerations		Comments
	Advantages	Disadvantages	Advantages	Disadvantages	
FORD (see Dwg. 15)					
<ul style="list-style-type: none"> drive equipment across streambed 	<ul style="list-style-type: none"> no instream construction maintains streamflow and fish passage 	<ul style="list-style-type: none"> high potential for sediment release depending on substrate rutting of streambed requires grading of banks possible sediment release during grading of banks 	<ul style="list-style-type: none"> fast easy can be located in many places inexpensive 	<ul style="list-style-type: none"> watercourse depth is a limitation vehicles may get stuck streambed may not be level and may require gravelling or construction of a travel pad (see below) 	<ul style="list-style-type: none"> coarse-textured substrate all sizes of shallow watercourses where sediment release is not a concern where fish passage needs to be maintained
TRAVEL PAD					
<ul style="list-style-type: none"> construct rockfill ford below surface of watercourse a modified ford crossing 	<ul style="list-style-type: none"> maintains streamflow and fish passage 	<ul style="list-style-type: none"> large amount of sediment release during construction and removal each pass of a vehicle creates sediment release requires bank grading may be a barrier to fish if poorly designed may act as a weir and flood upstream areas 	<ul style="list-style-type: none"> easy to build can be placed in most locations levels out uneven bottom 	<ul style="list-style-type: none"> potentially expensive difficult to remove requires 20 cm (minimum) of water flow to maintain fish passage may require select material to be imported 	<ul style="list-style-type: none"> all sizes of shallow watercourses where sediment release is not a primary concern useful on wide shallow rivers where no bridges are available used with cobble sized fill, preferably clean (no fines)
BARGE					
<ul style="list-style-type: none"> construct or import barge to carry equipment across watercourse 	<ul style="list-style-type: none"> no instream construction no sediment release maintains streamflow and fish passage 	<ul style="list-style-type: none"> banks require grading or a loading ramp may be required may require special restrictions and mitigation for fuel transport 	<ul style="list-style-type: none"> may be used in conjunction with crossing construction from barge 	<ul style="list-style-type: none"> may be difficult to obtain or build slow if multiple shuttles are required expensive requires sufficient depth to float barge specialized equipment inaccessible in some regions 	<ul style="list-style-type: none"> large, deep water crossings, generally proximal to urban centres large, deep water crossings where no alternative form of summer access is available (e.g., northern Canadian rivers)

Adapted from Mutrie and Scott 1984

4 Risk-Based Watercourse Crossing Selection Process

The success of a pipeline associated watercourse crossing depends upon the selection of an appropriate crossing method to prevent or reduce the adverse environmental effects of crossing construction. The following subsections identify issues and risks that proponents may wish to consider, assisting them in the selection of appropriate watercourse crossing techniques. Since this document is intended to be general in nature, the exact technique and protection measures implemented during a watercourse crossing may vary according to the specific requirements of the project and site-specific conditions at the watercourse crossing.

When highly sensitive or high profile watercourse crossings are anticipated to be a component of a proposed project, it is important that government agency representatives, technical specialists and affected stakeholders be contacted during the initial stages of route and crossing selection. Once contact is established, ongoing feedback between the proponent and the agencies will clarify the concerns and facilitate approvals.

Planning a pipeline watercourse crossing project involves many steps, from route selection to post-construction monitoring. There are several points in the planning process where the details of the proposed project will require it to proceed along a specific regulatory course. Figure 4.1 outlines the key steps in planning watercourse crossing construction projects.

4.1 DFO Risk Management Framework

DFO has established a national Risk Management Framework (RMF) to provide consistency to the determination of potential effects of development projects, including pipeline associated watercourse crossings, on fish and fish habitat (DFO 2005). The text in Sections 4.1.1 and 4.1.2 of this document is based on the DFO Risk Management Framework (DFO 2005) and readers should review the document for additional information.

This nationally standardized approach to managing risk allows DFO biologists, partner agencies and proponents to determine what fish habitat concerns are associated with a project, develop appropriate mitigation to address anticipated effects and assess the risk of residual negative effects to fish habitat.

The RMF consists of a Pathways of Effects (POE) model used to determine the potential effects on fish habitat resulting from a work, and a Risk Assessment Matrix (Figure 4.2) that incorporates the scale of any residual negative effects and the sensitivity of the specific fish and fish habitat to make a determination of the appropriate regulatory approach. The POE model is a tool used to list the predicted effects on fish and fish habitat caused by specified land- and water-based construction activities. If the POE model identifies any residual negative

effects caused by a proposed project that cannot be fully mitigated, then these effects are examined by DFO in the context of the Risk Assessment Matrix.

4.1.1 Elements of a Risk Management Program

A risk management program, including the DFO RMF, is composed of three principal parts:

- **risk communication:** description of the elements of risk using common language
- **risk assessment:** determination of the nature and probability of the elements of risk
- **risk management actions:** measures taken to reduce risk to the lowest practical level

Comprehensively managing the environmental risk of a crossing project must include all of the above elements. It is important that the steps taken to communicate, assess and manage risk are well documented.

4.1.2 Process for Assessing Risk to Fish Habitat

The process for assessing the risk to fish habitat posed by a crossing project involves several proponent-directed steps and a final risk evaluation and decision by DFO biologists (Figure 4.3). The proponent must first determine whether the crossing is located in fish habitat that directly or indirectly supports a fishery or has the potential to support a fishery, and whether an OS applies to the proposed crossing method. These OSs specify the crossing method, habitat characteristics and mitigation and monitoring measures under which the project may proceed without further DFO review. If no OS applies to the proposed crossing project, or if not all of the conditions of the OS can be met, then the proponent determines the potential effects on fish habitat using the POE model and designs mitigation measures to break the identified pathways.

In the next step of the risk assessment, DFO biologists evaluate the certainty associated with the proposed mitigation measures and the direction (positive, neutral or negative) of any residual effects. If negative residual effects exist, then DFO will use the Risk Assessment Matrix to determine the appropriate management approach, which could include an authorization to commit HADD under Section 35 of the *Fisheries Act*. Such authorization may or may not be granted, or may be subject to habitat compensation conditions, depending on where on the Risk Assessment Matrix (Figure 4.2) the residual effects fall.

Certainty Associated with Mitigation Measures

In order to determine if the crossing project design, as proposed, is adequate to avoid any negative residual effects on fish and fish habitat, the certainty associated with the proposed mitigation measures will be evaluated by DFO biologists. There are two key factors that are considered when evaluating the level of certainty:

- **effectiveness of proposed mitigation:** many mitigation measures are standard industry practice and have been employed by proponents and contractors for many years and have been proven to be effective. Other innovative mitigation measures can be used in a risk-based approach, however, the uncertainty associated with their effectiveness must be assessed and contingency plans put in place in case of failure; and
- **knowledge base of effects:** in some cases the effects of a project on fish and fish habitat are well understood and can be accurately predicted. In other cases, the effects are much less understood and mitigation and contingency planning must acknowledge this knowledge gap.

It is important to note that even a moderate level of uncertainty does not mean that the project cannot proceed. Rather, monitoring, contingency planning and thresholds past which work cannot continue must be considered and incorporated by the proponent into the project design and/or by DFO into the project authorization.

Scale of Negative Residual Effects on Fish and Fish Habitat

A negative effect on habitat may not necessarily be high risk. Some negative effects may be of such short duration, limited spatial extent or small magnitude that they are still considered to be low risk. Examination of the attributes of negative effects permits a qualitative determination of the scale of risk associated with them. These attributes include:

- **intensity:** the amount of change from the baseline conditions that is expected. This attribute is usually considered in the context of quantitative, measurable parameters (*e.g.*, temperature, flow, water quality measures);
- **spatial extent:** the geographic size of the anticipated effect, including zone of influence downstream;
- **duration:** the expected duration of the effect, from some lasting only minutes to other effects causing permanent change;
- **reversibility:** the likelihood that the effect will reverse as the system re-achieves equilibrium;
- **timing:** the time of the year at which the effect takes place. For example, effects during critical spawning windows have a larger scale of negative effect; and
- **extreme events:** unlikely, but extreme, events may be associated with a negative effect. Such extreme events may be caused by severe weather, failure

of mitigation or accidents and malfunctions. The probability and severity of potential extreme events must be considered.

An evaluation of the combination of all of these attributes will determine the placement of a negative effect on the y-axis (scale of effect) of the DFO Risk Assessment Matrix (Figure 4.2).

Sensitivity of Fish and Fish Habitat at Crossing Location

The second factor in the determination of the overall risk of a negative effect is the sensitivity of the fish and their habitat at the location of the proposed crossing project and within its zone of influence. This factor is of importance as the overall risk of a negative effect of moderate scale will be greater in a habitat or fish community of higher sensitivity. The categorization of the sensitivity of fish habitat includes the following attributes:

- **species:** the sensitivity to disturbance will vary with species of fish present at a crossing location and in the zone of influence;
- **flow:** ephemeral systems that only contain water for a short duration after a rainfall event are less sensitive than perennial systems that always contain water;
- **thermal regime:** coldwater systems are more sensitive to perturbations than warm water systems; and
- **use of habitat:** spawning and rearing habitats are more sensitive than migratory corridors, although interruption of corridors may diminish the production of fish;

An evaluation of the combination of all of these attributes will determine the placement of a crossing location and its zone of influence on the x-axis (habitat sensitivity) of the DFO Risk Assessment Matrix (Figure 4.2). Several of the attributes should be rated high for a habitat to be considered to be highly sensitive.

Residual Effects and the Risk Matrix

The Risk Assessment Matrix (Figure 4.2) allows proponents and DFO biologists to qualitatively determine what level of DFO management involvement should be applied to a proposed project. The scale of the effect and the sensitivity of the affected habitat, as described above, define where a negative effect falls on the matrix. This approach also guides a proponent's communication with DFO in determining whether an authorization, notification or no contact is required for a particular crossing project.

The levels of management intervention by DFO, in increasing order, are:

- **no risk crossing:** no *Fisheries Act* requirements nor contact with DFO required;
- **low risk crossing:** follow available OSs and best management practices, submit notification to DFO;

- **medium risk crossing:** streamlined authorization process, regulations and class authorizations, letter of advice may be issued;
- **high risk crossing:** site specific DFO review and *Fisheries Act* authorization required, habitat compensation if residual negative effects; and
- **significant negative effects:** activity not permitted without intensive DFO consultation and habitat compensation measures, project approval questionable.

Role of Operational Statements in Project Review

DFO biologists have spent a great deal of time reviewing project proposals for which there is low or no risk to fish and fish habitat. In order to increase regulatory efficiency, DFO has produced OSs for low and no risk works that allow, under specific conditions, proponents to proceed with projects without DFO advice or approval. These OSs specify the crossing method, habitat characteristics and mitigation and monitoring measures under which the project may proceed without DFO review if all of the conditions and measures are implemented. Notification to DFO is requested prior to the commencement of the proposed works under the applicable OS. The information requested in the notification form is provided in order to evaluate the conformance of the work carried out in relation to the OS.

The most current OSs available in the province/territory where the project is to be constructed are provided in Table 2.2. It is the responsibility of the proponent to use the most current version of the OSs, visit DFO's website for the most current versions.

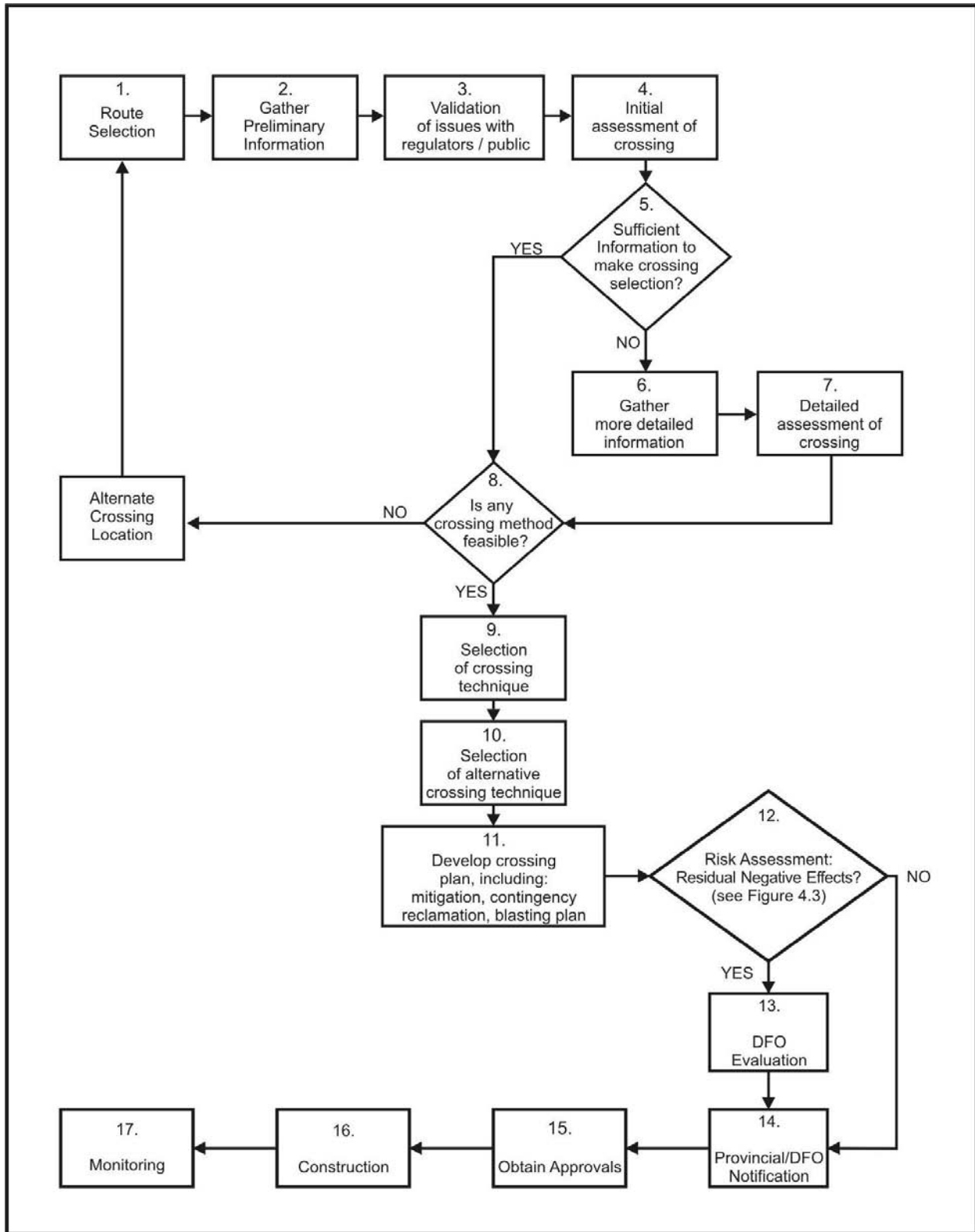

Figure 4.1 Planning Summary for Watercourse Crossings

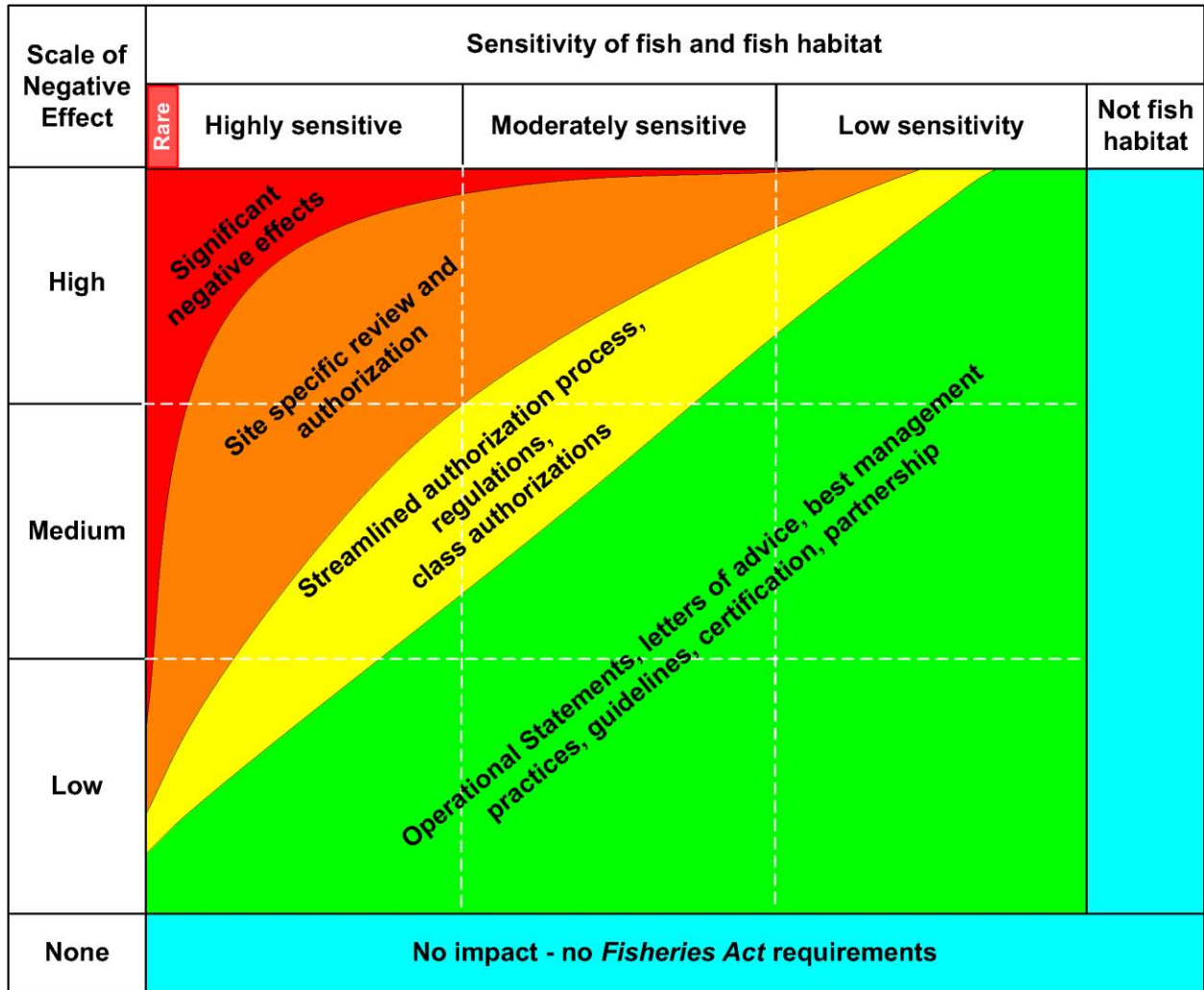

Figure 4.2 DFO Risk Assessment Matrix

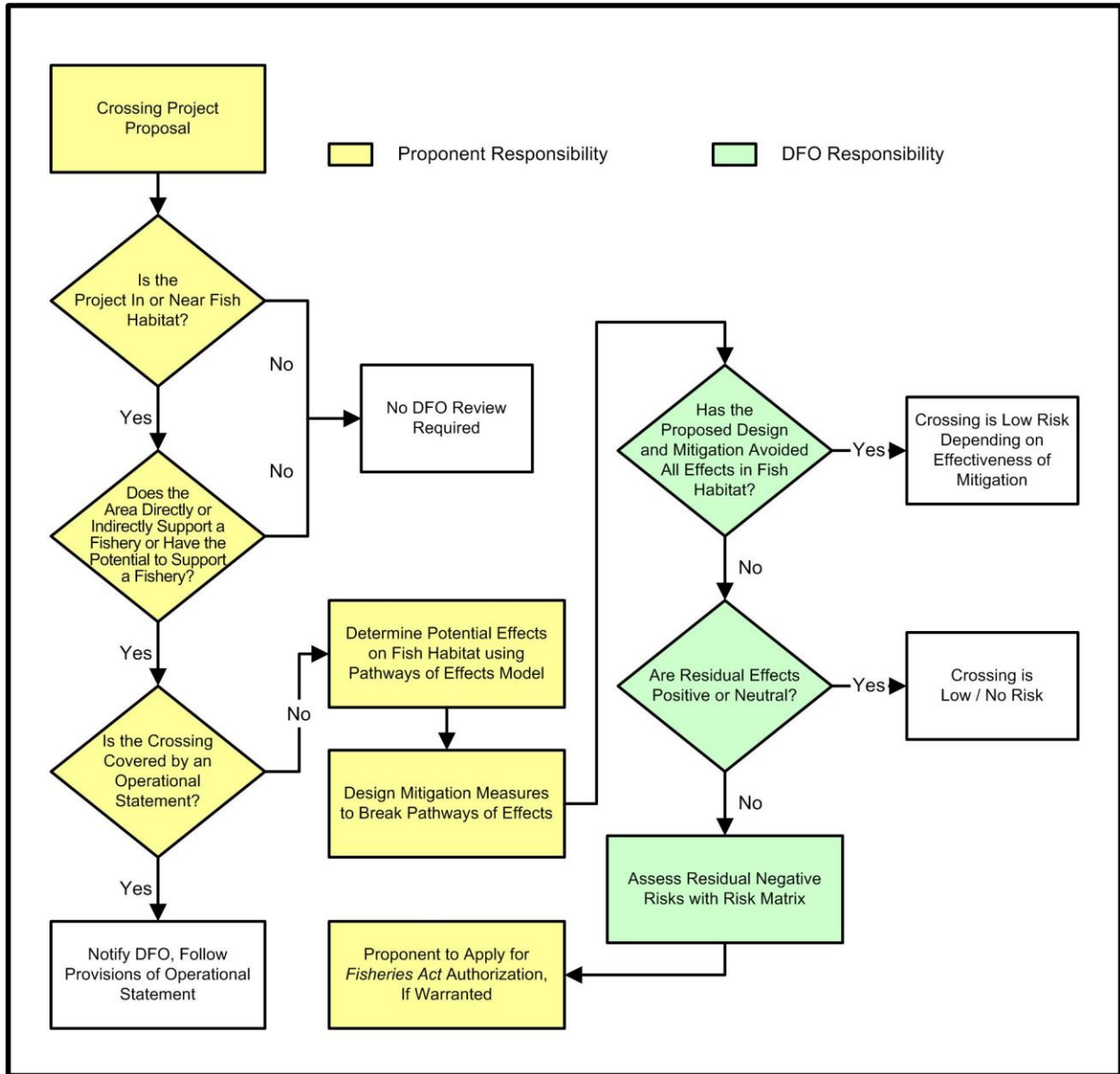

Figure 4.3 Process for Assessing Risk to Fish Habitat

4.2 Crossing Assessment

A site-specific environmental evaluation may be required where there are insufficient available data to adequately assess the risks associated with a crossing. Table 4.1 summarizes the general environmental considerations to be evaluated during an assessment.

4.2.1 Aquatic Assessment

The key objectives of an aquatic assessment are to:

- document preconstruction conditions;
- identify the level of sensitivity of the watercourse and aquatic resources;
- gather information for routing and crossing method selection; and
- develop appropriate mitigation measures.

In many cases, routine pipeline crossings of watercourses with known sensitivity do not require aquatic assessments since standardized mitigation, as outlined in Section 5.0 of this document, designed to protect the aquatic resources is implemented during construction. In situations where little information is known relative to the sensitivity further investigations are required.

The level of detail for these investigations will vary according to the watercourse and the construction techniques considered. Where crossing construction will not generally result in HADD of fish habitat (*i.e.*, reaches with limited habitat potential), field data collection should be limited to basic fish habitat information including: type of fish habitat (warmwater or coldwater), common fish species; and a general description of any fish habitat at the proposed crossing and within the zone of influence.

The level of detail required for field investigations can also vary based on the regulatory approval process expected for a watercourse crossing. For example, less field data may need to be collected for watercourse crossings that can be constructed under a DFO OS compared to a watercourse crossing that is submitted to DFO for review.

Where little information is available on a specific watercourse, yet regional information and initial routing investigations indicate that the watercourse may support sensitive or critical habitat, a more detailed aquatic assessment may be warranted. Table 4.2 presents a comprehensive list of parameters that could be evaluated. Generally, most watercourse assessments would include some, but not all those listed. Nevertheless, the greater the detail the more likely that the regulatory authorities will review and approve the crossing without delays caused by further field visits or additional meetings. Prior to conducting any assessments, proponents should discuss the level of detail required with regulatory agencies, at which time they may suggest the type of information and assessment requirements.

Table 4.1 Environmental and Engineering Considerations for Pipeline Crossing Selection

Considerations	Details
Geotechnical / Hydraulic	<ul style="list-style-type: none"> - depth of bedrock - stability of bedrock - contaminated substrates - slope stability -- bank height - watercourse discharge, velocities and roughness - channel depths/widths/slope/cross section - flood and low flow prediction/discharges - bank and substrate composition and stability - abandoned channels/floodplains - areas of scour, erosion and deposition - reach morphology - sediment transport potential - flow variation - water quality changes/depth of groundwater - future channel migrations - ice conditions - groundwater inflow - geotechnical results of subsurface conditions and potential for a successful trenchless crossing - potential to cross watercourse perpendicularly
Soils	<ul style="list-style-type: none"> - general soil composition - erosion hazard - chemical contamination - reclamation suitability
Vegetation	<ul style="list-style-type: none"> - rare and endangered species - existing disturbance at crossing
Fish and Wildlife	<ul style="list-style-type: none"> - fish species present - rare and endangered species - existing aquatic and terrestrial habitat - sensitive periods and timing constraints - spawning areas - nursery/rearing areas - fish overwintering areas - fish migration - wildlife overwintering or nesting areas - sensitivity of watercourse - existing barriers to fish migration - existing disturbance at crossing - proximity to known fish habitat - time of construction and potential for watercourse to be dry or frozen to bottom - beaver activity and potential for beaver dam removal
Land Uses	<ul style="list-style-type: none"> - existing rights-of-way - aesthetics - navigability and potential for impacts to navigation - recreational, domestic and commercial fishery - agricultural and/or recreational use contributing to erosion or sediment transport - Aboriginal traditional land use - historical, palaeontological and archaeological resources

Table 4.1 Environmental and Engineering Considerations for Pipeline Crossing Selection, Cont'd

Considerations	Details
Downstream Water Users	<ul style="list-style-type: none"> - licensed water use - domestic, municipal, agricultural and/or industrial water supply - irrigation/drainage - water quality changes (appearance, odour, taste, chemical contamination)
Cumulative Effects	<ul style="list-style-type: none"> - barriers to fish migration - fish mortality - number of adjacent watercourse crossings - number of watercourse crossings and barriers in watershed - total existing riparian clearing in watershed - total existing road network in watershed - public right-of-way use - need for access management - operation and maintenance requirements

Table 4.2 Detailed Aquatic Assessment Evaluation Parameters

General Characteristics	Land Use / Access
Date	Land Use
Name of Watercourse	Access
Kilometre Post	Recommended Work Side
Legal Land Location	
Topographic Map No.	
UTM Coordinates	Waterflow
Watercourse Length Inspected Upstream (m)	General Flow Characteristics
Watercourse Length Inspected Downstream (m)	Velocity (m/s)
Estimated Zone-of-influence	Discharge (m ³ /s)
General Terrain Setting	Stage
Floodplain Material	
Watercourse Navigability	
Photographs of Banks and Channel	Bank Characterization
Beaver Activity	Bank Stability
	Bank Height (m)
General Watercourse Characteristics	Bank Slope (%)
Mean Wetted Channel Width (m)	Approach Slope (%)
Mean Bank Full Width (m)	% of Bank with Riparian Vegetation
Length and depth of Pool / Run / Riffle (m)	% of Bank With Overhanging Vegetation
Ordinary High Water Mark (m)	% of Bank With Undercut
General Streambed Characteristics	Dominant Riparian Plant Species
Parent Streambed Material	Functional Riparian Width (m)
Bank and Channel Widths	
Bank Material Characterization	Substrate Characterization
Organics (%)	Bedrock (%)
Clay (%)	Boulder (%) (>25 cm)
Silt (%)	Cobble (%) (8 - 25 cm)
Sand (%) (<0.2 cm)	Gravel (%) (0.2 - 8 cm)
Gravel (%) (0.2 - 8 cm)	Sand (%) (<0.2 cm)
Cobble (%) (8 - 25 cm)	Silt (%)
Boulder (%) (>25 cm)	Clay (%)
Bedrock (%)	Detritus Present

Table 4.2 Detailed Aquatic Assessment Evaluation Parameters, Cont'd

Channel Characteristics	Water Quality
Location of Thalweg	Temperature (°C)
Stream Confinement	pH
Channel Cross Section	Conductivity (µs/cm)
Side Channel (%)	Dissolved Oxygen (mg/L)
Streambed Gradient (%)	Total Suspended Solid
Turbulence	Turbidity (NTU)
Natural Drop Offs	
Evidence of Bedrock Outcrops	Fish Sampling Results Summary
Sinuosity	Fish Collection Card
Habitat Features	Fish Reported in the Watercourse
Fish Habitat Potential and Habitat Features	Electrofishing(s)
Aquatic Macrophytes	Gill Netting (panel length x time)
Algae	Seining (net length x hauls)
Natural Barriers to Fish Movement	Minnow Trap (number of traps x time)
Artificial Barriers to Fish Movement	
	Available Overhead Cover %
Fish Captured	Percentage of Total Overhead Cover
Species	Large Organic Debris
Number	Undercut Bank
Fork Length	Overhanging Trees
Life Phase	Overhanging Shrubs
	Overhanging Grass
Erosion	
Bank Erosion Potential	
Evidence of Slumping on Banks	
Evidence of Slumping on Approach Slopes	
Evidence of Gulying	
Other Erosion Features	
Scour Potential	
Bed Erosional Potential	
Relative Sediment Transport Potential	
Relative Suspended Solids Load	
Groundwater Seepage	

Sources: Adapted from RIC (1999) and Alberta Transportation (2001).

Note: These parameters should be considered as a very comprehensive list and not those that should be used in all assessments. Aquatic assessments should be tailored to the size and sensitivity of the watercourse. This list should be used as a guideline from which to select those parameters that are appropriate for the size and sensitivity of the watercourse.

4.2.2 Geotechnical and Hydraulic Assessment

The objective of a geotechnical and hydraulic assessment is to identify long- and short-term processes that could affect habitat and water quality as well as the presence of potential hazards that may threaten the integrity of a pipeline and, to a lesser extent, vehicle crossing. In addition, a detailed geotechnical evaluation of subsurface conditions may be required for trenchless techniques (*e.g.*, horizontal directional drill).

Depending on the local conditions, the geotechnical and hydraulic assessment should include:

- river hydrology;
- geology of the approach slopes, bed and banks;
- drainage control on the approach slopes;
- slope stability; and
- bed scour.

In some cases it may be advisable to also consider surficial and fluvial materials.

River hydrology should be evaluated to identify the discharges that could be encountered during the period of construction and the potential discharges that could be encountered during a flood. Other streamflow information indicating which periods would not be suitable for construction should also be included.

The geology and surficial geology of the approach slopes, bed and banks of the watercourse should be identified and evaluated. Information on the type of substrate material aids in the determining of construction techniques, requirements for blasting and the potential for the introduction of sediment into the watercourse. The bank and approach slope geology analysis is used in establishing the stability of the slopes and in evaluating the likelihood of major channel migrations.

A geotechnical engineer should design detailed drainage and sediment control for the approach slopes. Examination of the approach slopes and textural classes of soils in the valley aids in the positioning of subdrains, trench breakers, silt fences, netting, cross ditches and diversion berms.

Before planning trenchless techniques, surficial and fluvial materials within the drill or bore path should be evaluated to determine whether they are appropriate for this method. Common techniques include ground penetrating radar (GPR) and drilling of bore holes.

4.2.3 Cumulative Effects

Watercourse crossings often contribute to cumulative effects on fish and fish habitat, wildlife and wildlife habitat and land and resource use. Planners and engineers should be aware of the issues, timing restrictions, mitigation measures, and possible regulatory requirements for assessing and managing cumulative effects.

Cumulative effects evaluations consider the combined effects now known to take place over larger study areas and longer time frames. Cumulative effects must be specifically considered for all individual watercourse crossings where HADD authorizations are required and for all NEB-regulated projects (see Section 2.1.4 of this document). Unlike aquatic assessments that focus on sensitivity and risk during the construction period, the primary objective of cumulative effects analysis is to identify and mitigate long-term effects on fish and wildlife mortality, movements, and maintenance of habitat availability and quality. This analysis recognizes that watercourse crossings and rights-of-way have an ‘indirect footprint’ that extends well beyond the physical footprint until native vegetation on and immediately adjacent to the right-of-way returns to pre-disturbance conditions.

In recent watercourse crossing applications, some projects have been required to assess the wildlife and vegetation resources of valleys associated with the watercourse. In particular, some jurisdictions pay special attention to overwintering ungulates (*i.e.*, moose, deer, elk), species with special conservation status (*e.g.*, *Species At Risk Act* or the Committee on the Status of Endangered Wildlife in Canada (COSEWIC) listed species, provincially listed species or migratory birds) or special status vascular plants (*e.g.*, *Species At Risk Act* or COSEWIC listed species or provincially listed species).

Cumulative effect assessment is an evolving practice and no standard accepted method exists for watercourse crossings. The level of effort should be appropriate to the number of crossings being considered, other existing watershed disturbances, and the combined long-term risk to fish and fish habitat. One of the key deficiencies of some approaches is that they overlook the long-term cumulative effects risk from: increased harvest; movement barriers (*e.g.*, culverts); and non-point sediment, nutrient, and contaminant input. Note that an assessment of other potential residual causes would also be necessary as part of the cumulative effects assessment.

A detailed discussion of analysis tools is beyond the scope of this document, however proponents and technical specialists should choose the most appropriate approach from the suite of tools described in Table 4.3. Additional information is provided in the *Filing Manual* (NEB 2004 and Hegmann *et al.* [1999]).

Table 4.3 Cumulative Effects Analysis Tools for Watercourse Crossings

Approach	Description	Advantages	Disadvantages
Qualitative	<ul style="list-style-type: none"> • Descriptive evaluation of potential cumulative effects associated with aquatic and terrestrial POE. Should consider construction and operations phases and entire watershed(s). 	<ul style="list-style-type: none"> • Lowest cost and time requirements. • POE can be explicitly discussed. 	<ul style="list-style-type: none"> • Analysis generally not systematic and transparent, increasing long-term risk to fish and fish habitat. • Effects of increased access and mortality (the proximate cause of most cumulative effects) generally not considered.
Species or Habitat Models	<ul style="list-style-type: none"> • Habitat-based models used to evaluate potential project-specific and cumulative effects on species or habitats of ecological, social, or economic importance (e.g., evaluate loss of brook trout spawning, rearing, and overwintering habitat). 	<ul style="list-style-type: none"> • Based on accepted impact assessment methods that consider habitat loss, the ultimate cause of cumulative effects. • Able to quantify species- and site-specific habitat loss or alteration requiring mitigation or compensation. • DFO guidance documents exist (e.g., Ford <i>et al.</i> 1995; Minns 1995, 1997; Minns <i>et al.</i> 1995, 1996; Portt <i>et al.</i> 1999). 	<ul style="list-style-type: none"> • High cost and time requirements. • Independent analyses of different species or habitats makes direct comparison of trade-offs difficult. • Generally underestimates long-term cumulative effects risk because all POE cannot be explicitly considered (e.g., habitat-based approaches generally overlook mortality risk, barriers, and chronic non-point effects; Warren and Pardew 1998; Angermeier <i>et al.</i> 2004).
Watershed Evaluations	<ul style="list-style-type: none"> • Calculate numerical measures of watershed or landscape conditions to evaluate incremental and cumulative effects risk (e.g., determine stream crossing density or area of roads within riparian corridors; BC MOF 1999). 	<ul style="list-style-type: none"> • Medium cost and time requirements. • Provides quick test to determine if project modifications or more detailed assessment are necessary. • Best able to document project contribution to long-term cumulative effects risk. 	<ul style="list-style-type: none"> • Does not quantify species-specific habitat loss or alteration. • Value of mitigation strategies may not be quantifiable because underlying mechanisms can differ.
Integrated Evaluations	<ul style="list-style-type: none"> • Combine habitat-based models with watershed evaluations to consider how local effects contribute to long-term watershed effects. 	<ul style="list-style-type: none"> • Combined benefits of both approaches. 	<ul style="list-style-type: none"> • Highest cost and time requirements; generally only done for very large or contentious projects or for watershed restoration. • Complex.

4.3 Environmental Selection Considerations

Selection and approval of watercourse crossings by the proponent and regulators, respectively, requires a thorough knowledge of the advantages and disadvantages of various crossing methods and techniques. Unfortunately, except for a few senior field personnel, most engineers, planners and regulatory staff do not attain sufficient experience to understand the various techniques to be able to sufficiently evaluate the risks of each. Tables 3.1 and 3.2 summarize the engineering and environmental advantages and disadvantages of the various techniques discussed in this document.

TERA Environmental Consultants (1996) and P.A. Harder and Associates Ltd. (1995) summarized a total of 326 pipeline associated watercourse crossing case histories as background documents to this document (Appendix B). These studies, although largely anecdotal, portray a good cross section of both successful and poorly constructed crossings.

In summary, unsuccessful watercourse crossing projects had the following problems:

- poor planning;
- no contingency planning;
- selection of an inappropriate construction technique for the conditions experienced during construction;
- inexperienced construction crews and inspectors;
- overestimation by the contractor of his ability;
- underestimation of the energy of a watercourse;
- insufficient quantity and size of equipment onsite;
- inadequate knowledge of the flows and subsurface conditions; and
- unforeseen/unanticipated circumstances.

Risk associated with the environmental aspects of a watercourse crossing project can generally be divided into three types: regulatory risk; construction risk; and post-construction risk.

4.3.1 Regulatory Risk

Risks associated with not fulfilling the regulatory requirements during a crossing may be twofold. Firstly, the project may be delayed or rejected if no or insufficient information is submitted. In the event that an application is approved, insufficient information may cause the regulatory agency to invoke restrictive conditions to ensure protection of the resources. Secondly, if a project proceeds without the appropriate approvals, shut downs, charges and potentially convictions may result.

In a regulatory climate in which more emphasis is being placed on codes of practice, OSs and other increasingly independent regulatory tools, industry can

expect that any violation of the regulatory requirements may result in more rigid interpretation of the legislation. Therefore, it is imperative that all permits and approvals are obtained and associated approval/permit/code of practice conditions are implemented to ensure compliance. Consider obtaining approvals for alternative crossing methods early in the planning process. This will minimize the risk of project delays during construction should the preferred crossing method fail and an alternative crossing approach be necessary.

4.3.2 Habitat Compliance Decision Framework

In an effort to clarify compliance decision-making and promote consistency and transparency in the decision-making process regarding compliance, DFO has developed the Habitat Compliance Decision Framework (HCDF) (DFO 2007a). This subsection was prepared based on information in the HCDF (DFO 2007a).

The purpose of the framework is to deal specifically with remediation and enforcement, which is outside of this manual's intended purpose. Refer directly to the HCDF document where more detail is required.

The HCDF consists of four components. Figure 4.4 shows the process map for the application of the HCDF. The components are:

- **compliance monitoring:** monitoring of DFO reviewed works or undertakings (*i.e.*, Authorizations, letters of advice, OS notifications) and monitoring of works or undertakings that have not been reviewed (*i.e.*, works DFO was previously unaware of, previously reviewed works or undertakings that are the subject of a complaint, or events related to the operation or maintenance of existing facilities and structures).
- **compliance risk assessment:** determine the impacts (real or potential) on fish and fish habitat and assess the compliance factors based on the Compliance Risk Assessment Matrix then categorize the level of compliance risk among four categories: no risk (green); minor risk (yellow); moderate risk (orange); and significant risk (red).
- **responding to the compliance issues:** an appropriate course of action is decided upon based on the level of risk; and
- **follow-up:** DFO ensures the measures required to address a compliance issue were implemented.

The process for determining the impacts on fish and fish habitat for non-compliance is similar to the process of determining risk in a proposal as described in Section 4.1 of this document. Risk is assessed using the scale of negative effect associated with a work or undertaking in the context of the sensitivity of fish and fish habitat being affected. Figure 4.5 shows the Compliance Risk Assessment Matrix used to illustrate the categories of risk associated with non-compliance.

Based on the assessment of impacts on fish and fish habitat and the assessment of the compliance factors, the colours of the compliance risk matrix (Figure 4.5) can be used to identify the level of risk among four categories:

- **no risk (green):** no violation of the habitat protection provisions of the Fisheries Act has occurred since compliance issues have not or will not result in impacts on fish and fish habitat;
- **minor risk (yellow):** resolution of the non-compliance issue can be completed by a combination of compliance promotion and assistance activities by DFO since the impacts (real or potential) on fish and fish habitat are medium to low;
- **moderate risk (orange):** DFO intervention by implementing additional mitigation measures would be required to bring the proponent into compliance. If this approach fails, the use of stronger measures to compel compliance may be considered since risks associated with the compliance factors can be relatively high or the potential impacts to fish and fish habitat may be characterized as high; and
- **significant risk (red):** Actions aimed at compelling a proponent to comply with the Fisheries Act since both the risks associated with the compliance factors can be relatively high and the potential impacts to fish and fish habitat may be characterized as high.

In following up to non-compliance, DFO will ensure the compliance issue has been resolved. Where measures required by DFO are not implemented, a new compliance risk assessment may be required. The compliance factors should be reconsidered to account for the failure to implement the measures required by DFO.

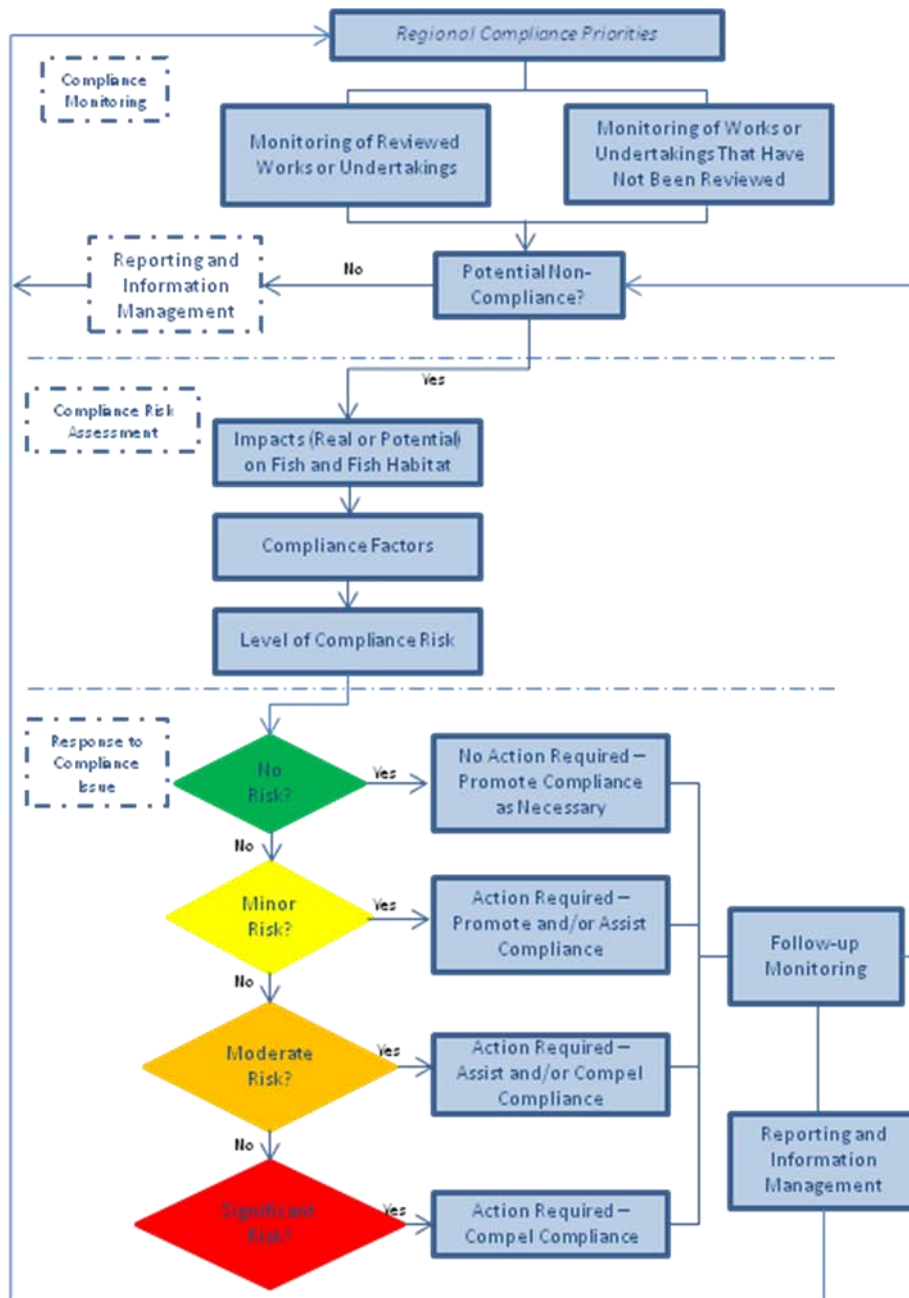

Figure 4.4 Process Map for the Application of the Habitat Compliance Decision Framework

adapted from DFO 2007a

		Impacts (Real or Potential) on Fish and Fish Habitat			
		High	Medium	Low	No Impacts
Compliance Factors	High				
	Medium				
	Low				

Figure 4.5 Compliance Risk Assessment Matrix

adapted from DFO 2007a

4.3.3 Construction Risk

Each watercourse crossing technique has its own risks, some for which can be difficult to plan and others for which it may be challenging to mitigate problems that arise. Selecting and approving crossing techniques must be done with a full knowledge of the risks and proponents and regulators should recognize the adverse effects that can occur. The risks associated with each technique will vary according to many factors. This includes but is not limited to: project scope; contractor's ability, experience and commitment; pipe size; and season of construction.

Table 4.4 summarizes some of the more common problems associated with various techniques and identifies the environmental risks associated with each. In addition, Table 4.4 provides an indication of the scale of the identified risks as well as general mitigation measures and contingency plans that should be considered in advance of construction during the planning phase.

4.3.4 Post-Construction Risk

Proponents evaluate the short-term risks associated with various crossing techniques, but may not consider some of the longer-term, life-cycle factors. The following considerations should also factor into the planning and crossing design:

- long-term stability of slopes, stream banks and approach slopes;
- erosion and sedimentation;
- maintenance;
- pipeline integrity;
- monitoring;
- ongoing use of the right-of-way by off highway terrain vehicles; and
- other land uses.

In many situations, the long-term implications of operating a pipeline in a particular location may strongly affect the decisions regarding crossing technique, construction methods and reclamation.

Table 4.4 Risk Considerations for Watercourse Crossing Methods*

Selected Potential Problems ¹	Environmental Risk(s)	Scale of Risk ²	Mitigation and/or Contingency Plan(s)
OPEN TRENCHED: Plow, Bucket Wheel Trencher			
Unexpected extended periods in watercourse	Prolonged sediment load and deposition	Medium	Work through the night, ensure approvals are in place for extended periods, utilize larger and more equipment
Erosion of instream spoil storage	Prolonged sediment load and deposition	Medium	Ferry as much spoil to shore as practical
Equipment too small and prolonged instream activity	Prolonged sediment load and deposition	Medium	Bring in larger and more equipment
Fine textured substrate	Increased suspended solids introduced into water column during trench, backfilling and from spoil storage area	High	Prepare a sediment control plan in advance
Loss of ditch as a result of unstable bed materials	Prolonged sediment load and deposition	High	Work through the night, ensure approvals are in place for extended periods, obtain larger and more equipment
OPEN TRENCHED: Hoe			
Unexpected extended periods in watercourse	Prolonged sediment load and deposition	Medium	Work through the night, ensure approvals are in place for extended periods, utilize larger and more equipment
Erosion of instream spoil storage	Prolonged sediment load and deposition	Medium	Ferry as much spoil to shore as practical
Equipment too small and prolonged instream activity	Prolonged sediment load and deposition	Medium	Bring in larger and more equipment
Fine textured substrate	Increased suspended solids introduced into water column during trench, backfilling and from spoil storage area	High	Prepare a sediment control plan in advance
Loss of ditch as a result of unstable bed materials	Prolonged sediment load and deposition	High	Work through the night, ensure approvals are in place for extended periods, obtain larger and more equipment
OPEN TRENCHED: Dragline			
Equipment failures	Prolonged sediment load and deposition	Medium	Ensure sufficient back-up equipment is available
Unexpected extended periods in watercourse	Prolonged sediment load and deposition	Medium	Work through the night, ensure approvals are in place for extended periods, utilize larger and more equipment
Fine textured substrate	Increased suspended solids introduced into water column during trench, backfilling and from spoil storage area	High	Prepare a sediment control plan in advance, ensure approvals are in place for alternate crossing
Loss of ditch as a result of unstable bed material	Prolonged sediment load and deposition	High	Work through the night, ensure approvals are in place for extended periods, utilize larger and more equipment
OPEN TRENCHED: Dredging			
Unexpected extended periods in watercourse	Prolonged sediment load and deposition	Medium	Work through the night, ensure approvals are in place for extended periods, utilize larger and more equipment
Loss of ditch as a result of unstable bed materials	Prolonged sediment load and deposition	High	Work through the night, ensure approvals are in place for extended periods, utilize larger and more equipment

Table 4.4 Risk Considerations for Watercourse Crossing Methods, Cont'd

Selected Potential Problems ¹	Environmental Risk(s)	Scale of Risk ²	Mitigation and/or Contingency Plan(s)
ISOLATED: Flume			
Leaking dam or flange	Increased water pumping and disposal concerns, flooding of work area and washout of dam	High	Ensure there are sufficient materials on hand to keep dams and flanges sealed
Flume may be of insufficient diameter	Uncontrolled flow through isolated area	High	Ensure that flume is sized to at least 150% of maximum anticipated flows and pumps are on standby to assist in a partial bypass
Flume is too long, straight or large for reach or watercourse	Undue disturbance to riparian habitat, banks and bed	High	Consider switching to an alternative technique Ensure flume is properly sized
Ditch water disposal problem	Water pumped onto land flows back to the watercourse	Medium	Have additional stand by pumps on hand and identify suitable settling ponds/sumps
Icing of flume pipe in winter	Work area flooding	High	Have additional stand by pumps on hand and identify suitable settling ponds/sumps
Flume may be of insufficient length and/or ditch excavation becomes too wide and threatens flume installation	Increased suspended solids introduced into water column in the event of a flume collapse	High	Have additional standby pumps at hand to assist in a partial bypass Consider switching to alternative technique or properly sized flume
Approaches too steep to thread bends in pipe under flume	Excessive grading, reclamation and bank restoration	Medium	Replace flume with high volume pumps or dam and pump to allow easier lowering in of pipe
Groundwater seepage into work area	Increased water pumping and disposal concerns	Medium	Have additional stand by pumps at hand and identify suitable settling areas
ISOLATED: Dam & Pump			
Dam poorly sealed	Increased water pumping and disposal concerns, potential washout of dam and flooded work area	High	Ensure there are sufficient materials at hand to keep dams sealed
Insufficient pump capacity (by design or icing of pump hose)	Work area flooding and increased water pumping and disposal concerns	Medium	Have additional stand by pumps and hoses at hand and identify suitable settling areas
Pump malfunctions	Work area flooding and increased water pumping and disposal concerns	Medium	Have additional stand by pumps and hoses at hand
Dam topped or washed out	Increased suspended solids introduced into water column in the event of a collapse	High	Have additional stand by pumps and hoses at hand and identify suitable settling areas
Ditch water disposal problems	Water pumped onto land flows back to the watercourse	Medium	Have additional standby pumps and hoses on hand and identify suitable settling ponds/sumps
Groundwater seepage into work area	Increased water pumping and disposal concerns	Medium	Have additional stand by pumps and hoses at hand and identify suitable settling areas
ISOLATED: High Volume Pump (Sump and Pump)			
Pump malfunctions	Work area flooding and increased water pumping and disposal concerns	Medium	Have additional stand by pumps and hoses at hand
Insufficient pump capacity (by design or icing of pump hose)	Work area flooding and increased water pumping and disposal concerns	Medium	Have additional stand by pumps and hoses at hand and identify suitable settling areas

Table 4.4 Risk Considerations for Watercourse Crossing Methods, Cont'd

Selected Potential Problems¹	Environmental Risk(s)	Scale of Risk²	Mitigation and/or Contingency Plan(s)
Ditch water disposal problems	Increased water pumping and disposal concerns	Medium	Have additional stand by pumps and hoses at hand and identify suitable settling areas
Groundwater seepage into work area	Increased water pumping and disposal concerns	Medium	Have additional stand by pumps and hoses at hand and identify suitable settling areas
ISOLATED: Cofferdam			
Ditch water disposal problems	Water pumped onto land flows back to the watercourse	Medium	Have additional stand by pumps and hoses at hand and identify suitable settling areas
Groundwater seepage into work area	Increased water pumping and disposal concerns	Medium	Have additional stand by pumps and hoses at hand and identify suitable settling areas
Insufficient pump capacity (by design or icing of pump hose)	Work area flooding and increased water pumping and disposal concerns	Medium	Have additional stand by pumps and hoses at hand and identify suitable settling areas
Pump malfunctions	Work area flooding and increased water pumping and disposal concerns	Medium	Have additional stand by pumps and hoses at hand
Dam poorly sealed	Increased water pumping and disposal concerns, potential washout of dam and flooded work area	High	Ensure there are sufficient materials at hand to keep dams sealed
Dam failure	Work area flooding, increased suspended solids introduced into water column and safety	High	Have additional dam building materials at hand (<i>i.e.</i> , median barriers and water-filled dams)
ISOLATED: Channel Diversion			
Erosion and flushing of large quantities of material in 'new' channel - especially if not lined	Flooding and increased suspended solids introduced into water column	High	Line channel or use a water diversion tube/ structure
Dam poorly sealed	Increased water pumping and disposal concerns, potential washout of dam and flooded work area	High	Ensure there are sufficient materials at hand to keep dams sealed
Dam failure	Work area flooding, increased suspended solids introduced into water column and safety	High	Have additional dam building materials at hand (<i>i.e.</i> , median barriers and water-filled dams)
TRENCHLESS: Bore			
Caving-in of bellhole	Failure of bore leads to subsequent attempts and possible additional land requirements	Low	Ensure sufficient land is obtained to attempt subsequent attempts and a protection plan is in place to minimize land disturbance
Bellholes fill with water	Inability to de-water bell-holes leading to abandonment of technique	Medium	Ensure measures are in place to handle de-watering and approvals in place for alternative techniques
Boulders prevent punching or ramming tool from progressing	Failure leads to subsequent attempts and possible additional land requirements	Medium	Ensure sufficient land is obtained for subsequent attempts and ensure approvals are in place for alternative techniques
TRENCHLESS: Punch/Ram			
Boulders prevent punching or ramming tool from progressing	Failure leads to subsequent attempts and possible additional land requirements	Medium	Ensure sufficient land is obtained for subsequent attempts and ensure approvals are in place for alternative techniques

Table 4.4 Risk Considerations for Watercourse Crossing Methods, Cont'd

Selected Potential Problems ¹	Environmental Risk(s)	Scale of Risk ²	Mitigation and/or Contingency Plan(s)
Bellholes fill with water	Inability to dewater bell-holes leading to abandonment of technique	Medium	Ensure measures are in place to handle de-watering and ensure approvals are in place for alternative techniques
TRENCHLESS: Micro-tunneling			
Caving-in of bellhole	Failure of bore leads to subsequent attempts and possible additional land requirements	Low	Ensure sufficient land is obtained for subsequent attempts and a protection plan is in place to minimize land disturbance
Bellholes fill with water	Inability to de-water bell-holes leading to abandonment of technique	Medium	Ensure measures are in place to handle de-watering and approvals in place for alternative techniques
Boulders prevent punching or ramming tool from progressing	Failure leads to subsequent attempts and possible additional land requirements	Medium	Ensure sufficient land is obtained for subsequent attempts and ensure approvals are in place for alternative techniques
TRENCHLESS: Horizontal Directional Drill			
Collapsed hole, stuck drill stem, lost tools	Failure leads to subsequent attempts and possible additional land requirements	Low	Ensure sufficient land is obtained for subsequent attempts and ensure approvals are in place for alternative techniques
Loss of circulation	Failure leads to excavation to find cause of lost circulation and possible additional land requirements	Low	Ensure sufficient land is obtained for excavation and ensure approvals are in place for alternative techniques Activate contingency plan if frac-out is occurring or suspected
Drill mud seepage directly into watercourse	Prolonged sediment load and deposition	High	Ensure a drilling mud contingency plan is in place
Drill mud seepage onto land and then into watercourse	Prolonged sediment load and deposition	Medium	Ensure a drilling mud contingency plan is in place
Washout of cavities and collapse of right-of-way	Sink holes on right-of-way	Low	Ensure sufficient equipment is on site to strip topsoil, grade sink hole and reclaim area
	Sink holes under watercourse	Medium	Ensure a drilling mud contingency plan is in place
AERIAL: Bridge Attachment			
Target for vandalism	Release of product	Low	Ensure company has an emergency response plan tailored to address the issue
AERIAL: Self Supporting Bridge			
Target for vandalism	Release of product	Low	Ensure company has an emergency response plan tailored to address the issue

Notes: 1 Sources: P.A. Harder and Associates Ltd. (1995), TERA (1996), authors' experience
 2 Scale of risk incorporates probability of occurrence and severity of effect.

* DFO provided the following detailed comment - Risks might also include: fuel/oil/hydraulic fluid spill; flooding due to rain or upstream rain; hitting larger substrates than expected; often times bank stabilization doesn't hold - needs to be revisited and re-enforced; failure of sediment fences; overwhelming of dewatering pits; inability to relocate all the fish; need to extend work into fish spawning/migration times; freezing temperatures; and permafrost addressed, or freezing of streambed - which could lead to fish migration barrier.

4.4 Economic Selection Considerations

In selecting a watercourse crossing technique, proponents and regulatory agencies must evaluate the economic considerations at each particular site. Ideally, the cost of protective measures should be related to the social or environmental ‘value’ of the resource potentially at risk. For this reason, the economic costs associated with various construction techniques must be balanced against the potential adverse environmental effects.

4.4.1 Direct Costs

The direct costs of various crossing techniques are difficult to predict for the following reasons:

- depth of cover, pipe diameter and substrate composition will strongly influence the costs;
- most small crossings are constructed by mainline crews and are built into the line cost for construction of the entire pipeline;
- more difficult crossings bid at a fixed price will have a contingency factor built into the price to allow for subsequent attempts or contingencies;
- all crossings and site conditions are different and the actual costs may vary significantly;
- many contractors are reluctant to give actual prices since the industry is competitive based on bid prices; and
- maintenance costs of fish habitat mitigation /compensation.

Nevertheless, Table 4.5 outlines the relative cost that can be expected based on various techniques and watercourse sizes.

4.4.2 Indirect Costs

In evaluating the economics of a crossing, possible reductions in indirect costs are often overlooked. For instance, directionally drilling a watercourse may lead to considerable savings since no bank reclamation or ongoing maintenance will be necessary at that location and mitigation requirements for other resources (*e.g.*, wildlife habitat) may be reduced or avoided. Conversely, horizontal directional drilling may be disproportionately expensive if contractors are unavailable, extensive geotechnical evaluation is needed prior to construction or large volumes of drilling fluids require disposal. Table 4.6 identifies relative costs associated with various activities and requirements of each watercourse crossing method.

Table 4.5 Relative Costs^{1,2} of Watercourse Crossing Techniques

Technique	Small Watercourses <10 m Wide	Medium Watercourses 10-20 m Wide	Large Watercourses >20 m Wide
OPEN TRENCHED			
i) Plow	low	n/a ³	n/a
ii) Bucket / Wheel Trencher	low	n/a	n/a
iii) Hoe	low	low	low to high
iv) Dragline	n/a	high	high
v) Dredging	n/a	high	high
ISOLATED			
i) Flume	low to moderate	moderate	n/a
ii) Dam and Pump	low to moderate	moderate	n/a
iii) High Volume Pump Bypass	low to moderate	moderate	n/a
iv) Cofferdam	n/a	high	high
v) Channel Diversion	n/a	high	high
TRENCHLESS			
i) Boring	low to moderate	moderate	moderate
ii) Punching / Ramming	low to moderate	moderate	high
iii) Horizontal Directional Drilling	low to high	low to high	low to high
iv) Micro-tunnelling	n/a	very high	very high
AERIAL			
i) Bridge Attachment ⁴	low to moderate	low to high	low to high
ii) Self-Supporting Bridge or Span	moderate to high	high	high

Notes:

There are many watercourse characteristics such as width, depth, channel shape, flow volume and substrate composition that affect the cost of each crossing. Most crossings have to be evaluated on a case by case basis. The above relative costs are based on the following assumptions:

- No bedrock is encountered during construction (*i.e.*, drilling and blasting costs are not considered).
 - Single pipe, small diameter crossings (4" to 12").
 - Larger, more complex crossings should be assessed on a site-specific basis.
 - All isolation techniques assume trench excavation by backhoe.
1. This table identifies relative costs of construction methods compared to the lowest cost, technically feasible technique that would be selected if no consideration was made of environmental risk.
 2. The provision of relative costs in the table does not imply that the crossing method is generally environmentally suitable - see Table 4.6.
 3. n/a = not applicable / practical
 4. The bridge used to attach the pipeline to in the 'Bridge Attachment' option must be along the pipeline route or additional costs will be incurred to reach the bridge.

Table 4.6 Economic Considerations of Watercourse Crossing Methods

Activities and Requirements of Watercourse Crossings	Type of Technique															
	Open Trenched					Isolated					Trenchless				Aerial	
	Plow	Trencher	Hoe	Dragline	Dredging	Flume	Dam and Pump	High Volume Pump	Coffer dam	Channel Diversion	Bore	Punch / Ram	Horizontal Directional Drill	Micro-tunnelling	Bridge Attachment	Self-Supporting Clear Span Bridge
Design and geotechnical investigation	L	L	M	M	M	M	M	M	H	H	M	M	H	M	H	H
Availability of experienced contractors and the ability to obtain competitive bids	M	L	M	H	H	M	M	M	H	H	M	H	H	H	H	H
Special permits and approvals	M	M	M	M	M	M	M	M	M	H	L	L	L	L	H	H
Extra temporary workspace	L	L	M	H	H	M	M	M	H	H	M	M	H	M	L	H
Land surveying	L	L	M	M	M	M	M	M	M	H	M	M	H	M	L	H
Clearing	L	L	M	H	H	M	M	M	M	H	M	M	M	M	L	L
Grading	M	M	M	M	M	L	M	M	L	H	L	L	L	M	L	L
Trenching / drilling	L	L	M	H	H	H	M	M	H	H	M	M	H	H	X	X
Special materials	M	M	M	M	M	H	H	M	H	H	M	M	H	M	H	H
Special equipment	M	M	M	H	H	H	H	H	H	H	H	H	H	H	H	H
Disruption of navigation and recreation	L	L	M	H	H	H	H	H	H	H	X	X	X	X	X	X
Dewatering	X	L	M	M	M	H	H	H	H	H	H	H	X	H	X	X
Special instream mitigative measures	L	L	M	M	M	H	H	M	H	H	X	X	X	X	X	X
Bank reclamation and restoration	M	M	M	H	M	M	M	M	H	H	X	X	X	X	X	X
Inspection	L	L	M	H	H	H	H	H	H	H	L	L	H	M	H	H
Site / work area access	L	L	M	H	H	M	M	M	H	H	M	M	H	M	H	H
Operations and maintenance	M	M	M	M	M	M	M	M	M	M	L	L	L	L	H	H
Habitat compensation	M	M	M	M	M	M	M	M	M	M	X	X	X	X	X	X

Notes:

- H - High Greater time and cost requirements than with traditional hoe construction
- M - Moderate Traditional construction costs and time requirements
- L - Low Less than traditional construction costs and time requirements
- X - Nil No costs or time requirements

4.5 Crossing Method Selection

4.5.1 Pipeline Crossings

The selection of a watercourse crossing method often causes the greatest conflict between industry and regulatory agencies. In recent years, the expectations of the regulatory agencies have evolved to the point that in some jurisdictions, proponents are informed that no instream activity is permitted in flowing waters that have the potential to support any fish. In other jurisdictions, industry has become accustomed to a regulatory environment that permits instream activity as long as it is not within restricted activity periods. In either situation, it is prudent to select a crossing method in a logical and reproducible manner based on site conditions, sensitivity and mitigation potential.

In selecting a watercourse crossing method, many factors must be taken into consideration. These include, among others:

- pipeline diameter;
- crossing width, depth and flow characteristics;
- environmental sensitivity;
- instream timing constraints;
- geotechnical concerns including bank stability, bank height and the approach slope gradient and stability, and erosion potential;
- substrate composition;
- hydrological data;
- costs;
- navigation;
- amount of working space required and available;
- regulatory constraints;
- equipment availability;
- contractor expertise;
- downstream water users;
- landowner and community input;
- traditional ecological/environmental knowledge;
- engineering constraints; and
- season.

The selection of a final method is an exercise in striking a balance among the considerations listed above and potentially others, to derive the most practical solution. The method that is preferred is usually that which is technically feasible and offers the required level of environmental protection for the lowest cost.

Some projects have related crossing methods to established sensitivity criteria for each watercourse. This leads to a reproducible selection of crossing methods. A more detailed matrix included in the application may allow some regulatory agencies to follow the logic behind the selection process and approve in principle other crossings as long as the proposed methods are used.

Since there are many factors, more complicated crossing selection flow diagrams have usually not been practical. It, therefore, falls upon the environmental planner and engineer to use professional judgment and experience to evaluate all the factors in the final technique selection.

Table 4.7 summarizes considerations that can be used in selecting a watercourse crossing technique. The table is based on generic crossings and, where several techniques are suggested, the decision as to which will be selected will depend on detailed evaluation of specific concerns.

Table 4.7 provides guidance for the selection of a crossing technique. However, the most appropriate technique for a specific project should be determined on a case-by-case basis. Depending on circumstances, regulatory agencies may have different requirements in regard to their preferred method of crossing. For example, DFO may consider such factors as site location, geographic particularities, type of fish communities affected, regional fisheries management priorities, etc., which may lead to regional differences in preferred crossing methods. There is no automatic selection process.

It should be recognized that no one technique is a panacea for environmental protection and both regulatory and industry representatives must be familiar with the advantages and disadvantages as well as the risk(s) associated with each technique. These are discussed in Sections 4.3 and 4.4 of this document.

In many situations, regulatory agencies are asked to approve crossing methods with insufficient data and, consequently, take a conservative approach. In these situations, the agencies have responded with an assumption that aquatic resources may be adversely affected unless the proponent indicates otherwise. The onus falls on the proponent to undertake a suitable assessment to assist in the selection of the crossing technique and to communicate the probability of success of the method selected to all parties included in the review of the project. Detailed information, extensive site-specific planning and communication of procedures between the proponent and contractors are required to ensure high probability of success. Where insufficient information is submitted, the proponent can expect that the project may not be reviewed in a timely manner or may be approved only with the most restrictive conditions.

Table 4.7 Pipeline Crossing Construction Technique Selection Considerations

Watercourse Construction Method		Small Watercourse <10 m Wide			Medium Watercourse 10-20 m Wide			Large Watercourse >20 m Wide		
		Environmental Sensitivity ¹			Environmental Sensitivity ¹			Environmental Sensitivity ¹		
		Low	Moderate	High	Low	Moderate	High	Low	Moderate	High
OPEN TRENCHED	Plow	Y	x	x	n/a	n/a	n/a	n/a	n/a	n/a
	Wheel Ditcher	Y	x	x	n/a	n/a	n/a	n/a	n/a	n/a
	Backhoe	Y	x	x	Y	Y	x	Y	Y	x
	Dragline	n/a	n/a	n/a	\$	\$	x	Y	Y	x
	Dredging	n/a	n/a	n/a	\$	\$	x	Y	Y	x
ISOLATED	Flume	Y	Y	Y	Y	Y	Y	\$	Y	Y
	Dam and Pump	Y	Y	Y	Y	Y	Y	\$	Y	Y
	High Volume Pump	Y	Y	Y	Y	Y	Y	\$	Y	Y
	Coffer Dam	n/a	n/a	n/a	\$	Y	Y	\$	Y	Y
	Channel Diversion	n/a	n/a	n/a	\$	Y	Y	\$	Y	Y
TRENCHLESS	Boring	Y	Y	Y	Y	Y	Y	Y	Y	Y
	Punching	Y	Y	Y	Y	Y	Y	\$	\$	\$
	Micro-tunnelling	n/a	n/a	n/a	\$	\$	Y	\$	\$	Y
	Horizontal Directional Drill	\$	Y	Y	\$	Y	Y	\$	Y	Y
AERIAL	Bridge Attachment	\$	\$	Y	\$	\$	Y	\$	\$	Y
	Self-Supporting	\$	\$	Y	\$	\$	Y	\$	\$	Y

NOTES:

- Environmental sensitivity levels of watercourses are dependent on factors that vary regionally across Canada. The proponent, in consultation with provincial, territorial and federal fisheries authorities and other aquatic specialists, should determine the environmental sensitivity of a particular watercourse crossing location. Parameters such as species present, habitat use, season, downstream use by water users, flow, thermal regime and the findings of an aquatic assessment may be included in a determination of sensitivity (see Table 4.2 for detailed assessment parameters).
- Watercourse sizes are defined below.

<p>Small</p> <ul style="list-style-type: none"> • <10 m bankfull width with flows that can be readily dammed or pumped for isolated crossings 	<p>Medium</p> <ul style="list-style-type: none"> • 10-20 m bankfull width which can be generally dammed, flumed or pumped and can be excavated by backhoes from each bank 	<p>Large</p> <ul style="list-style-type: none"> • >20 m bankfull width that are too wide to construct from the banks unless specialized equipment is used. These cannot be dammed, flumed or pumped
--	---	--
- Y - the method is generally environmentally suitable, but may require habitat compensation measures

\$ - the method is environmentally acceptable, however, may not be practical due to the high construction cost

x - this method is generally not environmentally suitable, but may be permitted if habitat compensation is implemented

n/a - not usually practical from an engineering or construction standpoint

Adapted from Alberta Environment 1988

4.5.2 Vehicle Crossings

In selecting a vehicle crossing technique, many factors must be taken into consideration. These include, among others:

- pipeline construction technique;
- crossing width, depth and flow characteristics;
- environmental sensitivity;
- geotechnical concerns including bank stability, bank height and erosion potential;
- substrate composition;
- hydrological data;
- costs;
- navigation;
- amount of working space;
- regulatory constraints;
- equipment availability;
- contractor expertise;
- construction season;
- engineering constraints;
- seasons of use;
- proximity of alternative crossing structures;
- frequency of use;
- duration of use;
- weight of equipment; and
- contractor's responsibilities.

As with the selection of pipeline crossing method, the selection of a vehicle crossing technique also involves striking a balance between the considerations listed above and potentially others, to derive the most practical solution. The technique that is preferred is usually that which offers the required level of environmental protection for the lowest cost based on the pipeline construction technique selected.

Table 4.8 summarizes considerations that can be used in selecting a vehicle crossing technique. The table is based on a generic crossing where several techniques are suggested. The decision as to which will be selected will depend on detailed evaluation of specific concerns and pipeline construction techniques.

Table 4.8 Vehicle Crossing Technique Selection Considerations

Vehicle Crossing Method		Small Watercourse <6 m Wide			Medium Watercourse 6-15 m Wide			Large Watercourse >15 m Wide		
		Environmental Sensitivity			Environmental Sensitivity			Environmental Sensitivity		
		Low	Moderate	High	Low	Moderate	High	Low	Moderate	High
BRIDGES	Existing Bridge	Y	Y	Y	Y	Y	Y	Y	Y	Y
	Temporary Bridge	Y	Y	Y	Y	Y	Y	\$	\$	\$
	Ice Bridge	Y	Y	Y	Y	Y	Y	Y	Y	Y
FILLS	Swamp Mats	Y	x	x	Y	x	x	n/a	n/a	n/a
	Log/Pipe Fill	Y	x	x	x	x	x	n/a	n/a	n/a
	Snow Fill	Y	Y	x	Y	Y	x	n/a	n/a	n/a
	Ramp and Culvert/Flume	Y	Y	x	Y	x	x	n/a	n/a	n/a
FORDS	Travel Pad	\$	x	x	Y	x	x	Y	x	x
	Ford	Y	x	x	Y	x	x	Y	n/a	n/a
BARGE	Barge	n/a	n/a	n/a	\$	\$	\$	\$	Y	Y

NOTES:

1. Environmental sensitivity levels of watercourses are dependent on factors that vary regionally across Canada. The proponent, in consultation with provincial, territorial and federal fisheries authorities and other aquatic specialists, should determine the environmental sensitivity of a particular watercourse crossing location. Parameters such as species present, habitat use, season, downstream use by water users, flow, thermal regime and the findings of an aquatic assessment may be included in a determination of sensitivity (see Table 4.2 for detailed assessment parameters).

2. Watercourse sizes are defined below.

- | | | |
|------------------------------------|--------------------------------------|-------------------------------------|
| Small | Medium | Large |
| • watercourses <6 m bankfull width | • watercourses 6-15 m bankfull width | • watercourses >15 m bankfull width |

3. Y - the method is generally environmentally suitable, but may require habitat compensation measures.

\$ - the method is environmentally acceptable, however, may not be practical due to the high construction cost relative to the sensitivity.

x - this method is generally not environmentally suitable, but may be permitted with habitat compensation.

n/a - not usually practical from an engineering or construction standpoint.

Adapted from Alberta Environment 1988

5 Environmental Mitigation Procedures

The following subsections outline various environmental mitigation procedures that should be considered and, if necessary, implemented to ensure a successful crossing.

5.1 Planning and Design

The level of planning and design undertaken for a watercourse crossing will depend upon watercourse sensitivity and project magnitude as well as the jurisdictional requirements. Prior to application, the applicant should ensure that the information requirements are clarified with the regulatory agencies and that required information is submitted as part of the documentation. Failure to do so may result in unnecessary delays in review.

Consultation with the appropriate regulatory agencies is advisable in all jurisdictions since it generally simplifies the planning process and facilitates approval of the application. Environmental non-government organizations with an interest in fish, fish habitat or aquatic environments (*e.g.*, Trout Unlimited Canada), other environmental groups, landowners, users (*e.g.*, outfitters and guides), and licensed water users and other interested parties (*e.g.*, Aboriginal groups) should also be consulted when construction is planned in sensitive environments. As with the regulators, failure to undertake appropriate stakeholder consultation may result in unnecessary delays and added costs.

The following detailed plans could be required as part of a complete application, or should be considered for a construction bid package:

Typical Crossing Design ¹	Contingency Plans ²
Detailed Crossing Design ¹	- Alternative crossing methods
Environmental Protection Plan ²	- Floods
Environmental Alignment Sheets	- Waste and hazardous material
Crossing Detail Alignment Sheets	- Spills
Reclamation Plan ²	- Drilling mud release
Erosion and Sediment Control Plan ²	- Archaeological or palaeontological discovery
Habitat Restoration and Enhancement Measures ²	- Rare and endangered species discovery
Compensation Agreement(s)	- Fire
Post-Construction Monitoring	- Construction delays

Notes:

1. These are generally engineering documents but may be developed to include environmental protection measures.
2. Components of these plans are included in Section 5.2 of this document. For contract and application purposes, it is easier to have these as standalone documents.

DFO, and other applicable regulators, consider the contents of some of these plans (e.g., Erosion and Sediment Control Plan) to be very important when reviewing and understanding pipeline construction related activities to be undertaken at medium and highly sensitive crossings.

In jurisdictions not requiring such detailed information, proponents should consider inclusion of as much information as feasible in the construction bid documents to ensure that the contractors are bidding appropriately and that there will be no 'extras'. With their inclusion in the bid documents, there is a greater level of confidence that the contractors and inspectors will act in the manner expected by the proponent and regulatory agencies and not 'do it the way it is always done'.

5.2 Crossing Construction

The following construction procedures are discussed regarding the installation of vehicle crossings and watercourse crossings:

- general;
- surveying;
- clearing;
- topsoil handling;
- grading;
- welding and weighting;
- instream blasting;
- construction of isolated crossings;
- pipe installation;
- instream sediment control;
- subsurface drainage control;
- backfilling;
- surface erosion control;
- clean-up and reclamation; and
- temporary vehicle crossings.

Standard environmental protection measures and procedures (e.g., Alberta Environment 1988 or other region-specific guidance) should be employed during construction although the following specific considerations are examples of additional measures that could be incorporated during each stage of construction where appropriate.

5.2.1 General Mitigation Procedures

The following measures are general in nature and should be considered regardless of construction activities. Such measures should be considered for inclusion in the environmental protection plan whenever practical.

- Schedule construction to occur during periods of lowest sensitivity to aquatic life and avoid unusually wet, rainy, or winter thaw weather conditions.

- All reasonable efforts should be made to minimize the duration of instream work.
- Abide by all relevant timing constraints (fish, ungulate, avian, etc.). Ensure that no construction activity occurs within the wetted portion of the channel during the restricted activity period.
- Prepare contingency plans for fuel and hazardous waste spills, streambank erosion, storm runoff and floods.
- Prepare an emergency monitoring and response plan for use in the event of a frac-out during a horizontal directional drill. If drilling fluids are entering or could enter a waterbody, follow the contingency plan. The appropriate environmental regulatory agencies must be notified immediately.
- Develop water quality monitoring plans, where needed. Refer to Section 7.0 of this document.
- Do not discharge or dispose of petroleum products and/or waste into waterways or onto the ground.
- Ensure waste storage areas are above the high water mark and sited to prevent blockage of drainage or risk introduction of waste material into a watercourse.
- Change oil, refuel and lubricate mobile construction equipment well away from the normal high water mark of a waterbody to minimize the potential for water pollution.
- Ensure that all oil changes, refuelling and lubrication of immobile equipment well away from the normal high water mark of a waterbody is undertaken in a manner such that any spillage will not enter the waterbody.
- Spent oils, lubricants and filters, etc. are to be collected and disposed of at an approved location and in an appropriate manner.
- Ensure that the following measures are employed to minimize the risk of fuel spills:
 - all containers, hoses and nozzles are free of leaks;
 - all fuel nozzles are equipped with automatic shut-offs;
 - operators are trained and stationed at both ends of the hose during fuelling unless the ends are visible and are readily accessible by one operator; and
 - fuel remaining in the hose is returned to the storage facility.
- Ensure that all fuel and service vehicles carry a spill kit with a minimum of 25 kg of suitable commercial sorbent material, 30 m² of 6 mil polyethylene, a shovel and one fuel barrel (lid removed).
- Store fuel within containment berms constructed to a capacity of 110% of the fuel stored or within double-walled tanks.
- Do not store hazardous materials, chemicals, fuels, or lubricating oils near the normal high water mark of a waterbody or near any surface drainage location. All such storage areas must be suitably contained.
- Fuel trucks, fuel storage areas, pumps, generators and other sources of deleterious substances must be within a containment system of sufficient capacity to ensure that deleterious substances do not enter fish habitat.
- Do not perform concrete coating activities near a watercourse unless suitable isolation from surface drainage and watercourses is ensured.

- Do not wash any type of equipment or machinery in watercourses or lakes. Control wastewater from construction activities, such as equipment washing or concrete mixing, to avoid discharge directly into any body of water.
- Ensure that the hydraulic, fuel and lubrication systems of any equipment working instream are in good repair to avoid leakage. Operate all equipment in a manner that prevents deleterious substances from entering fish habitat.
- Consider using vegetable based hydraulic oils in hydraulic systems working near watercourses or instream.
- Thoroughly inspect and clean equipment of oils, mud and vegetative debris before commencement of project.
- Any aquatic plants uprooted or cut during excavation should be removed and disposed of on land in an approved disposal site. It is important that these plants not be deposited in another body of water.
- Determine the presence of aquatic or riparian noxious weeds which construction equipment could carry forward from an infested to a clean area.
- Hose down, thoroughly wash potentially infested equipment and purge and clean all pumps before proceeding from one area to the next if noxious weeds or other pest species such as zebra mussels are known to be present in the area.
- Locate sources of clean gravel, cobble and riprap, if needed, prior to construction and place onsite for stabilization and restoration.
- Ensure that all material that is placed within the wetted perimeter of a watercourse is not toxic to fish.
- Ensure the appropriate vehicle crossing technique is employed (see Section 4.5.2 of this document).
- Wash all equipment transferred between major watersheds to ensure that aquatic pests are not transferred.
- Ensure all personnel entering a watercourse abide by recommended protocols (*e.g.*, recommended by BC MFLNRO in BC) for disinfecting waders and gear to avoid transporting aquatic invasive species. Construction workers who are anglers will also be notified of the protocols and urged to comply with these and the angling regulations of the province/territory.
- Any time sediment laden water is pumped into the bush, it should exit onto some form of velocity dispersion device and the discharge pathway needs to be monitored to prevent erosion in those upland areas which could have an impact on future drainage patterns and cause significant erosion in relatively pristine areas.
- Where water is pumped from fish habitat for any purpose, intakes are to be screened according to DFO's *Freshwater Intake End-of-Pipe Fish Screen Guideline* (DFO 1995a).
- Additional conditions and mitigation measures on the proposed works received from regulatory agencies in their approvals/permits must be incorporated into the mitigation program.
- Review all mitigation and regulatory requirements during the pre-job meeting involving the appropriate personnel (*i.e.*, contractor, Environmental Inspector,

proponent representative, water quality monitoring crews and/or subcontractors) to ensure that all mitigation measures are understood and can be implemented.

5.2.2 Surveying

Since the surveyor may select the initial crossing location, it is important that the following points be considered.

- Verify the final alignment of watercourse crossings to ensure that areas of particular concern are avoided. Environmental staff/consultant and/or project manager should conduct verification.
- Survey parallel to the fall line on approach slopes to watercourses. Avoid side slopes, drainages and unstable terrain. Survey pipeline crossings perpendicular to watercourses, wherever practical.
- Work should avoid realignment of watercourses.
- Ensure sufficient extra workspace is taken for working area on the approach slopes and at the watercourse crossing. Workspace boundaries should be well marked.
- Locate staging area at least 10 m away from streambanks, where topographic conditions permit.
- Minimize staging area size needed to construct the watercourse crossing.
- Identify and locate existing lines, especially hot lines, including burial depths.
- Mark or flag any sensitive environmental features within the construction area.
- Ensure a photographic record is made of all sensitive features to be protected or restored.

5.2.3 Clearing

Clearing can lead to erosion of the approach slopes, bed and banks as well as sedimentation and the obstruction of the watercourse. The following points are designed to minimize the potential adverse environmental effects of clearing (*e.g.*, increased potential for erosion and sedimentation of the watercourse) and should be considered for inclusion in the environmental protection plan.

- Flag clearing boundaries prior to commencing clearing operations.
- Minimize clearing to prevent erosion and loss of riparian habitat.
- Consider using tracked vehicles on steep terrain to minimize the need for shoo-flies.
- Limit nontracked vehicle traffic to approved shoo-flies on steep approach slopes.
- Postpone clearing of slopes and banks until immediately prior to construction, unless otherwise approved by the regulatory authority/Environmental Inspector and landowner. Avoid preclearing in the vicinity of watercourses.
- Leave a temporary uncleared buffer zone extending back from the crest of erosion prone slopes.

- Postpone disturbance of the vegetated buffer zone of the watercourse until necessary.
- Remove trees, debris or soil inadvertently deposited within the high water mark of watercourses in a manner that minimizes disturbance of the bed and banks. Do not fell, stand or yard trees across a watercourse. Do not drive logs into a watercourse even when dry.
- Implement Surface Erosion Control Measures as outlined in Section 5.2.13 of this document.
- Avoid long-distance skidding of timber on steep slopes adjacent to watercourses.
- Retain timber for riprap, logfill crossings, temporary bridges, rollback and/or corduroy, if warranted. Only use timber approved of by the applicable government representative or landowner. Place material so as not to hinder crossing construction.
- Chip or mulch slash and spread on steep erosion-prone slopes.
- Leave an undisturbed organic mat on the work side of the right-of-way as a buffer zone to limit the potential for sediment to enter the watercourse.
- Delay grubbing on slopes adjacent to a watercourse or within 10 m of the watercourse banks until construction of crossing is imminent.
- Restrict root grubbing near watercourses. Do not grub within 10 m of a watercourse except along the trench line. Only grub the spoil pile area if absolutely necessary. Leave an undisturbed organic mat on work side to minimize the potential for introduction of sediment into the watercourse.
- Maintain low vegetation within the 10 m buffer of watercourses to the extent practical by walking, storing and constructing over the undisturbed areas.
- Note that clearing and grubbing within 10 m of watercourses may be appropriate if completion of these activities will result in a reduction in erosion and sedimentation risk.
- Dispose of all nonmerchantable timber and slash not used for corduroy or rollback to the satisfaction of the landowner and regulatory authority. Methods of disposal include burning, chipping and mulching, or bucking and stockpiling (firewood). Combinations of methods may be needed depending on site and regulatory conditions.
- Do not locate burn areas within the wetted perimeter of a watercourse and avoid locating burn piles on organic soils. Dispose of all partially burnt stumps and logs above the high water mark to the satisfaction of the landowner and regulatory authority.
- Do not use tires, petroleum products, waste oil, waste chemicals or other wastes to ignite fires.
- Suspend clearing during heavy rains.

5.2.4 Topsoil Handling

Poor topsoil or strippings handling can result in increased erosion, sedimentation and possibly blockage of streamflow and insufficient reclamation following construction. Strippings are considered to be layers of humus-bearing topsoil and

fine woody material including some of the upper mineral soil. The following points should be considered.

- Implement Surface Erosion Control Measures as outlined in Section 5.2.13 of this document.
- Strip topsoil/strippings under nonfrozen and/or dry conditions, where practical.
- Delay stripping of approach slopes, floodplains and banks until immediately prior to construction.
- Strip topsoil/strippings from all areas to be graded.
- Strip topsoil/strippings during nonfrozen conditions from all areas to be used for approach slope spoil storage and from where instream spoil sump is to be constructed.
- Ensure graded and excavated subsoil are stored separately from topsoil/strippings.
- Stockpile salvaged topsoil/strippings above the high water mark of the watercourse and in a location that will prevent erosion and siltation of the watercourse.
- Place topsoil/strippings in distinct piles above the high water mark in a manner that does not block drainage or runoff, construction activities, or replacement of grade material or trench spoil and prevents erosion and siltation into the watercourse.
- Store topsoil in low piles 0.5 m or less to prevent compaction effects on soil organisms. This will help with revegetation efforts.
- Contour and stabilize with an approved cover crop if topsoil/strippings piles are to remain through the winter or for an extended period of time.
- Suspend topsoil/stripping handling during wet conditions. Recommence once field conditions improve.

5.2.5 Grading

Poor grading can result in increased erosion, slope instability, sedimentation and blockage of streamflow. The following points should be considered where appropriate.

- Ensure snow graded from the right-of-way is stored in a manner that does not lead to increased erosion during spring melt.
- Ensure that melting 'dirty' snow is not allowed to run-off directly into watercourses.
- Implement Surface Erosion Control Measures as outlined in Section 5.2.13 of this document unless approved by a geotechnical engineer.
- Minimize grading on steep slopes. Grading should be limited to only permit access by tracked vehicles. Rubber-tired traffic should be limited to approved shoo-flies.
- Do not place graded material on steep slopes or closer than 20 m to the crests of slopes. Cuts and fills should not exceed 3:1 slope.

- Minimize disturbance of natural drainage channels during grading; avoid blocking channels with graded material.
- Remove bank grade with backhoe and store it a sufficient distance back from the watercourse.
- Grade away from watercourses to reduce the risk of material entering a watercourse. Do not place fill material in a watercourse during grading.
- Grade only the trench line and spoil containment areas. Grade the work side and crossing approaches only if warranted for safe operation of equipment. Grading within 10 m of the watercourse may be appropriate if completion of this activity results in a reduced erosion and sedimentation risk.
- Minimize the area of disturbance along the streambank. Do not grade the entire width of the right-of-way in proximity to a watercourse.
- Minimize grading when constructing bridge, fill or ford crossings.
- Plow and store snow for snowfill crossing prior to earth-moving activity to maintain clean snowfill.
- Contour and stabilize excess grade material if piles are to remain through the winter or for an extended period of time.
- Install temporary erosion control measures such as silt fence and/or temporary berms immediately following grading to prevent erosion from the approach slopes from entering the watercourse. Ensure erosion control measures are maintained and repair if warranted.

5.2.6 Welding and Weighting

Welding and weighting of pipe should be undertaken in a manner that allows quick installation and the least amount of adverse environmental impact. The following points should be considered where appropriate.

- Assemble the pipeline segment to be installed in the watercourse in an upland area and utilize ‘push-pull’ or ‘float’ technique to place the pipe in the trench whenever water and other site conditions allow.
- Complete welding, coating, testing and weighting of the pipe prior to commencement of trenching. Completion of welding, coating and weighting of the pipe may be deferred, to a limited extent, at large watercourses where a substantial instream trenching period is anticipated.
- Ensure that sufficient equipment is available to move long heavy sections of pipe efficiently at long crossings.

5.2.7 Instream Blasting

When considering instream blasting as an approach to remove bedrock for the installation of a pipeline watercourse crossing, these measures should be followed:

- Consider less destructive or more controlled methods of removing bedrock, if practical, such as ripping. These methods are preferable to blasting.

- Consult with provincial or territorial fisheries biologists and wildlife biologists in addition to regulatory agencies early in the planning phase should blasting in or near streams be considered.
- Consult with DFO as early as possible in the planning process if the use of explosives is unavoidable, to identify and discuss practical alternatives, aquatic resources and mitigation measures. DFO may, upon review of a project proposal, provide a letter of advice, issue an Authorization under Section 32 and/or Subsection 35(2) of the *Fisheries Act*, or decide not to issue Authorization(s). In arriving at one of these determinations, DFO will take into account, among other things, whether:
 - the use of explosives is the only technically feasible means of breaking bedrock such that it can be excavated from the trench;
 - sensitivity of habitat, fish presence and timing; and
 - the use of explosives is required to alleviate an emergency situation.

Mitigation measures specific to the use of explosives in or near fisheries water may be implemented in order to effectively minimize the destruction of fish and/or the HADD of fish habitat. These measures could include, but are not limited to the following:

- use of staggered/delayed blasting times in conjunction with decked charges to reduce overall shock wave;
- scheduling of blasting for periods of least biological activity for the watercourse, especially avoiding spawning, incubation, overwintering and migration periods;
- deploying bubble/air curtains to dampen the shock wave;
- displacing fish from blast area (e.g., use small charge blasting caps) and employ shock wave buffers (e.g., air curtains) to minimize adverse effects;
- using confined explosives (i.e., contained within the substrate) instead of unconfined explosives;
- avoiding the use of ammonium nitrate based explosives, specifically nitrate-fuel oil mixtures in or near water due to the potential for toxic by-product production (ammonia).

5.2.8 Isolated Crossing Methods

The following mitigative measures should be implemented during construction of crossings using an isolation method:

- Maintain downstream flow within the natural watercourse at all times with no change in water quantity or quality.
- Water from flumes, pump-around, diversions or other methods used to maintain downstream flow must not cause erosion or introduce sediment into the channel.
- If a pump-around method is used to maintain downstream flow, back-up pumps with adequate capacity to maintain downstream flow must be on site at all times and ready to take over pumping should the operating pumps fail. The operating pumps should be continually monitored to ensure downstream flow

is maintained at all times until the dam materials are removed and normal flows restored to the channel.

- Pump intakes must not disturb the streambed. Pump intakes used in fish bearing waters must be screened with a maximum mesh size of 2.54 mm and a maximum screen approach velocity of 0.038 m/s.
- Earthen berms should not be used for isolation or the construction of an off-stream diversion channel.
- All berms and material must be completely removed from the channel and the streambed and bank profiles be returned to preconstruction conditions at the end of the project.
- Sediment laden water in the work area should be discharged to an upland vegetated area prior to removal of the isolation dams.
- Fish salvage should be conducted using a seine net, dip net and/or electrofishing and the fish released unharmed upstream. Fish salvage should be undertaken within any isolated areas prior to and during dewatering activities. In addition, fish salvage should be undertaken on any bypass structures such as diversion channels and flumes prior to them being dewatered after use. Fish salvage may require a permit from the province/territory.

5.2.9 Pipe Installation

The specific procedures that may be implemented during pipe installation depend on the crossing technique. See Dwgs. 1 to 11 for specific techniques. Other general measures include:

- Stop trenching activities short of watercourse banks or where deep burial is to occur to prevent silty trench water from entering the watercourse. Leave hard trench plugs in place until the watercourse crossing has been initiated. The recommended minimum plug width is 3 m.
- Construct a sump, with berms, silt fences or straw bale filters to contain excavated instream spoil so that silty runoff does not re-enter watercourse. Prevent instream spoil from flowing off right-of-way (see Dwgs. 16, 17 and 18).
- Ensure subsurface flow along the stream channel is maintained if critical habitats downstream could be affected by a blockage in flow.
- Dewater the trench onto stable surfaces in a manner that does not cause erosion of soils, sedimentation of watercourses, or where icing will not be a problem.
- Dewater the trench or boreholes so that the water is released into a well vegetated area or settling basin and does not directly re-enter any watercourse. Water returning to a watercourse must be equal to or in exceedance of background quality of the watercourse.
- Salvage vegetation plugs from streambank to aid in bank reclamation. Store in a manner that they can be replaced during clean-up.
- Suspend instream work if sedimentation is occurring. Implement further protection measures to control sediment loading.

- Ensure the watercourse is restored to its natural gradient and elevation to prevent barriers to fish movement.
- Install spare pipelines, where appropriate, for future use.

5.2.10 Instream Sediment Control

The generation of sediments cannot always be avoided during the construction of watercourse crossings; however, there are methods that may be used to minimize and control the location, dispersion and extent of sediments transported downstream. These are discussed in detail in *Instream Sediment Control Techniques - Field Implementation Manual* (Trow Consulting Engineers Ltd. 1996).

The use of filtering devices is not generally recommended since the materials have very low permeability rates, quickly lose their filtering potential and are susceptible to damage from streamflows. The use of geosynthetic textile products to filter silt and clays may only be appropriate in very low velocities (<0.026 m³/s).

Other instream sediment controls are designed to reduce water velocities and allow for settling of suspended materials in closer proximity to a trench excavation than would naturally occur. These controls are generally limited to controlling the transport of heavier suspended sediments that are temporarily within the water column. Such techniques are normally used in close proximity to the crossing since most of the coarser particles settle out naturally within a few hundred metres of the excavation.

Recent construction experience with sediment mats (*e.g.*, Sedimat) has indicated that placement of these woven mats downstream of the crossing, especially in sensitive habitats, traps large amounts of bedload and suspended sediment. These mats are removed after construction and, if biodegradable, can be used during bank restoration.

Special care is required when designing and installing instream sediment controls, particularly in flowing watercourses. Selection of the appropriate method for a stream, river, wetland or lake crossing is generally based on the following criteria:

- flow velocity and volume;
- crossing depth and width;
- seasonal conditions;
- environmental sensitivity;
- bed material; and
- trench excavation method.

Although conditions may appear suitable for instream sediment controls, their use must be carefully examined since their suitability and effectiveness are often overestimated. The use of instream sediment controls may be prohibited by factors such as: costs; physical obstructions (such as access, instream debris,

freezing conditions, blockage of fish passage); potential downstream sedimentation as a result of installation, maintenance and removal; damming of flows; chance of failure; ability to handle floods and increased flows; and their potential to become sources of bed or bank erosion. The type, design and placement of instream sediment controls should only be undertaken by a hydrological engineer or other qualified person.

All instream controls should be installed prior to construction and maintained throughout their installation period. Where possible and practical, accumulated sediment should be regularly removed to prevent accidental transport of collected sediments should the device fail. Disposal should be in a location and manner such that accumulated sediment is not allowed to re-enter any drainage system or receiving waterbody. Where removal would only cause additional sedimentation, the deposited material should be left in place and permitted to be removed naturally during the freshet. Instream controls should be removed before spring freshet if they are used through the winter season and prior to freeze-up if used during the fall.

The following types of instream sediment controls have been used in the past although no information has been collected on the acceptability of these techniques by regulators nor their effectiveness:

- check dam approach using shallow geotextile dams or stone for small streams of low velocity;
- deflector approach by installing logs, rocks or geotextiles to divert sediment-laden flow from sensitive fish habitat and to promote deposition of suspended solids in artificially created back eddy; and
- covering spawning beds with geotextiles or other suitable material, until construction is complete.

5.2.11 Subsurface Drainage Control

Drainage along the unconsolidated backfilled trench may cause instability and erosion, resulting in watercourse blockage and/or sedimentation, as well as threaten pipe integrity. Subsurface drainage must be diverted from the backfilled trench. The following points should be considered to ensure appropriate drainage.

- Install trench breakers constructed of sandbags, bentonite, urethane foam or other compacted impervious materials to force bellhole seepage along the pipeline trench to the surface on steep slopes (see Dwg. 19). Determine the location of trench breakers by onsite investigation considering the potential for subsurface flow, erodibility of backfill material and degree of slope. Mark location of trench breaker prior to backfilling.
- Install trench breakers adjacent to watercourses, at edges of wetlands and on other similar sites where unconsolidated backfill or organic materials are prone to washing out.
- Install subdrains or pole drains to divert shallow groundwater flow from the right-of-way and to improve slope stability (see Dwgs. 20 and 21).

- Install trench breakers on each side of a wetland where the pipeline trench crosses and may drain the wetland.

5.2.12 Backfilling

Backfilling should be performed in a manner that ensures erosion does not occur along the trench and that it does not result in a loss of fish habitat.

- Ensure backfill is well compacted on approach slopes and streambanks.
- Backfill with clean coarse material (*e.g.*, 2 cm diameter gravel or larger rock). All fill material is to be obtained from off-site and not from below the average high water level of any watercourse.
- Backfill from the centre of the watercourse towards the bank forcing silt-laden water back towards the ditch plugs. Silt-laden trench water should then be pumped onto vegetated land or into a sump.
- Lower backhoe bucket into water before releasing the backfill.
- Consider not backfilling instream trench, where sediment transport and sloughing will fill in the trench and backfilling with existing or select backfill will create excessive downstream sedimentation.

5.2.13 Surface Erosion and Sediment Control

Surface erosion should be controlled prior to, during and following crossing construction to minimize sedimentation. Erosion control measures should be considered as a primary means of sediment control and incorporated into all watercourse crossings during the planning stage. The following measures should be considered to minimize the amount of erosion and sedimentation.

- Regulate drainage from construction areas to prevent erosion and sedimentation.
- Ensure no ditch drains directly into a watercourse without proper sediment control devices.
- Install temporary berms on approach slopes immediately following clearing and grading.
- Install temporary silt fences (geotextiles or hay/straw bales) near the base of slopes if heavy rains or surface erosion could result in siltation of the watercourse (see Dwgs. 17 and 18).
- Install temporary silt fences (geotextiles or hay/straw bales) in any location where run-off from the right-of-way may flow into a watercourse.
- Inspect and clean silt fences on a regular basis, especially after heavy rainfalls.
- Install diversion berms and cross ditches, on disturbed steep approach slopes to divert surface water off the right-of-way (see Dwg. 22). Install sandbag, timber or bale berms on undisturbed pasture or well-sodded right-of-way. Determine location, type and direction of diversion berms in the field based on local topography, drainage patterns and land use. Ensure berms terminate in natural vegetation off the right-of-way. Stagger ends of berms if warranted. Install berms immediately downslope of trench breakers where installed. Ensure trench crown does not impede drainage or that a sunken trench does

not act as a drainage ditch. All designs should be made with input from a geotechnical engineer.

- Rollback stored, salvaged or imported small diameter slash (<5 cm) and walk down with dozer on steep erosion prone slopes on non-agricultural land. Install netting, mat binders, tackifiers, pegged sod or other products as warranted.
- Revegetate with an approved seed mix, as soon as practical, at twice the annual standard pasture rate. Incorporate a cover crop seed (*i.e.*, biannual fall rye, annual oats or barley) into mix as a cover crop. Note: Biannual fall rye should be incorporated for summer or fall seeding and annual oats for winter or spring seeding.
- Transplant native shrubs, plant willow stakes, or utilize other bioengineering techniques such as brush layering or wattling as warranted on steep erosion prone slopes on non-agricultural land. Schiechl (1980) discusses numerous bioengineering techniques (see Dwgs. 26, 27, 28).
- Consider applying netting or tackifier; laying and pegging sod, especially in urban areas; hydroseeding; seed impregnated mats; organic mulches such as straw, wood fibre, peat moss, wood chips or bark; brush matting; or other surface erosion control measures outlined in Table 5.1.
- Inspect erosion control structures until well established and stable, after major rainfalls and at least daily during periods of prolonged rainfall.
- Immediately repair erosion control structures that are found to be damaged.

5.2.14 Clean-up and Reclamation

Clean-up and reclamation should be performed to stabilize the disturbed area and to restore its aesthetic appearance.

- Commence clean-up at watercourses immediately following backfill and erosion control operations. Attempt to complete all phases of clean-up as quickly as practical. Where winter clean-up is hampered by frozen spoil and topsoil piles, complete rough clean-up prior to break-up and final clean-up after break-up.
- Remove corduroy from all locations wherever practical. Remove clay or sand caps overlying corduroy and ensure adequately sized culverts or other methods of cross drainage are present in any capped corduroy that is left in place. Dispose of corduroy, slash and any remaining leaning trees in the same manner as used for disposal of slash from initial clearing.
- Regrade streambanks and approaches to preconstruction profile, or to a maximum of 3:1 unless directed by a geotechnical engineer.
- Replace topsoil and any salvaged trees or shrubs.
- Revegetate streambanks and approach slopes with an appropriate native seed mix or erosion control mix. Seed a cover crop of fall rye, barley, oats or sterile hybrids such as triticale or wheat/wheatgrass.
- Broadcast seed, harrow in or hand rake on slopes. A seed drill should be used on level areas such as floodplains wherever practical. Hydroseeding can be used where access is good.

- Develop specific procedures, in coordination with the appropriate federal, provincial or territorial agency, to prevent the invasion or spread of undesirable non-native vegetation (*e.g.*, purple loosestrife, Eurasian milfoil).
- Do not fertilize in the immediate vicinity of a watercourse unless requested by the landowner and approved by DFO.

5.2.15 Temporary Vehicle Crossings

Temporary vehicle crossings for equipment and materials are commonly associated with pipeline crossings. The following mitigative measures should be implemented to avoid environmental damage.

- Whenever feasible, existing watercourse crossings should be used. Secondly, clear span bridges or ice/snow bridges should be used for temporary crossings.
- Remove crossing structures, where feasible, prior to freeze-up (for summer construction) and prior to break-up (for winter construction). Remove structures by physical means, not blasting. Crossing structures may be left in place only for final touch-up (*e.g.*, reseeding) if no other access is available and if they are designed to withstand high water flows during spring break-up.
- Any temporary crossing and associated debris must be removed immediately after completion of the pipeline crossing and the disturbed area restored to preconstruction conditions.
- Minimize the disturbance to riparian vegetation. When practicable, prune, top or walk down the vegetation instead of uprooting.
- Only clean ice/snow should be used for construction of ice bridges.
- Ensure water withdrawal does not exceed 10% of the instantaneous flow to avoid disruption of fish habitat.
- Ensure water flow is maintained, where it occurs naturally, under an ice bridge or snow fill.
- Sand or gravel or rock or loose woody material should not be used for an ice bridge or ice bridge approaches. Approaches should be constructed of compacted snow and ice of sufficient thickness to protect the stream and banks.
- Ice/snow bridges must be notched open prior to spring break-up when safe to do so and any associated debris removed from the watercourse. Banks and approaches should be stabilized and restored to preconstruction conditions.
- Only use clean and securely bound together logs when used for stabilizing shoreline approaches. Remove logs before spring break-up.
- Ensure that no excavation of the streambed occurs unless approved by DFO.
- If water extraction is necessary for the construction of temporary vehicle crossings, local regulations should be consulted for the maximum permissible withdrawal volume.

5.2.16 Abandonment

There are many factors to consider in deciding whether a section of pipeline crossing a water body should be abandoned in place or removed. More

specifically, the risks associated with abandoning the pipeline in place, including the potential for contamination and pipe exposure, have to be weighed against the cost and environmental impact of removal (Pipeline Abandonment Steering Committee [PASC] 1996).

These trade-offs should be assessed on a site-specific basis, taking into account the size and dynamics of the water body, the design of the pipeline crossing, soil characteristics, slope stability and environmental sensitivities. While these issues must be evaluated, in most cases it can be expected that abandonment-in-place will be the preferred option (PASC 1996).

Table 5.1 Erosion Control Techniques

Technique	Description	Advantages	Disadvantages	Comments
I. CONSTRUCTION PHASE				
Preserve existing vegetation	<ul style="list-style-type: none"> • maintain vegetation where practical • minimize grubbing and maintain root mat 	<ul style="list-style-type: none"> • inexpensive • permits infiltration by water • native vegetation maintained • minimal surface disturbance 	<ul style="list-style-type: none"> • possible congestion of construction traffic • may create unsafe working conditions • may impair erosion control in some conditions 	<ul style="list-style-type: none"> • applicable for slopes, streambanks and floodplains • aids reclamation practices • good in areas with erodible soils, sensitive vegetation • standard procedure to minimize disturbance
Minimize grading	<ul style="list-style-type: none"> • reduce cut and fills for minor depressions / gradient changes 	<ul style="list-style-type: none"> • inexpensive • reduces surface disturbance 	<ul style="list-style-type: none"> • may create unsafe working conditions • may impair erosion control in some conditions 	<ul style="list-style-type: none"> • applicable for gentle slopes, small hummocks and rolling topography • standard procedure to minimize disturbance
Silt fences (Dwg. No. 17)	<ul style="list-style-type: none"> • geotextile fences, partially buried, placed along slopes perpendicular to the fall line used to slow / block sediment transport along a slope • often at the base of slopes adjacent to watercourses • secured with steel rods or wooden posts 	<ul style="list-style-type: none"> • prevents saturated spoil / slopewash from entering a watercourse • minimizes erosion 	<ul style="list-style-type: none"> • possible obstacle to construction traffic • may washout / fail if not properly installed 	<ul style="list-style-type: none"> • temporary measure used on slopes with erodible soils to minimize sediment release into watercourses prior to revegetation
Straw bales (Dwg. No. 18)	<ul style="list-style-type: none"> • bales used to slow / block sediment transport along a slope • secured with steel rods or wooden posts 	<ul style="list-style-type: none"> • prevents saturated spoil / slopewash from entering a watercourse • minimizes erosion 	<ul style="list-style-type: none"> • possible obstacle to construction traffic • may washout / fail if not properly installed 	<ul style="list-style-type: none"> • temporary measure used on slopes with erodible soils to minimize sediment release into watercourses prior to revegetation

Table 5.1 Erosion Control Techniques, Cont'd

Technique	Description	Advantages	Disadvantages	Comments
Sediment trap	<ul style="list-style-type: none"> excavate minor depression(s) to allow sediment to settle 	<ul style="list-style-type: none"> does not require specialized equipment prevents large volumes of sediment from being washed away may be used in conjunction with silt fencing / straw bales 	<ul style="list-style-type: none"> may obstruct construction traffic spoil from sediment trap requires additional slope area may create a bigger mess 	<ul style="list-style-type: none"> used for isolated areas prior to final clean-up not common
Trench Breakers (Dwg. No. 19)	<ul style="list-style-type: none"> sacks (not foam or bentonite) are placed in the trench as a ditch plug to prevent washout of organic streambank 	<ul style="list-style-type: none"> relatively inexpensive may provide stable base for revegetation techniques 	<ul style="list-style-type: none"> labour intensive may fail if incorrectly installed resulting in large sediment volume release 	<ul style="list-style-type: none"> used for watercourses with organic banks which are susceptible to washing out must be keyed into trench walls for stability
Subdrains (Dwg. No. 20)	<ul style="list-style-type: none"> buried conduits providing surface release of subsurface water generally gravel wrapped in geotextile fabric or heavy plastic drain pipe(s) 	<ul style="list-style-type: none"> provides slope stabilization where springs are present maintains pipeline integrity by preventing trench washout 	<ul style="list-style-type: none"> expensive / labour intensive requires correct placement to be effective 	<ul style="list-style-type: none"> used in conjunction with cross ditches and diversion berms geotechnical consultation is recommended for correct placement correct installation is key
Temporary diversion berms	<ul style="list-style-type: none"> low subsoil berm across entire right-of-way used to divert surface water flow off the right-of-way 	<ul style="list-style-type: none"> inexpensive effective at diverting surface water flow can be readily installed and repaired 	<ul style="list-style-type: none"> due to low profile of berm(s), over topping / washout can occur during major precipitation event must be repaired on a daily basis 	<ul style="list-style-type: none"> applicable for approach slopes permanent berms will replace temporary berms during rough clean-up common practice
II. POST CONSTRUCTION / ROUGH CLEAN-UP PHASE				
Cross ditches and diversion berms (Dwg. No. 22)	<ul style="list-style-type: none"> ditches and berms crossing entire right-of-way slowing runoff to minimize erosion 	<ul style="list-style-type: none"> very effective if constructed correctly utilizes native materials aids in reclamation and revegetation 	<ul style="list-style-type: none"> may impede operations and maintenance activities not applicable for all soil types 	<ul style="list-style-type: none"> standard procedure for erosion control must be correctly placed in relation to slope and natural drainage in addition to trench breaker locations

Table 5.1 Erosion Control Techniques, Cont'd

Technique	Description	Advantages	Disadvantages	Comments
Brush bundles, fascines or wattles	<ul style="list-style-type: none"> • bundles of live cuttings tied produce sausage shaped bundles • planted in shallow trenches anchored with wooden or live stakes 	<ul style="list-style-type: none"> • can be used to direct or slow water movement and encourage vegetation growth on bank • don't require heavy equipment for installation 	<ul style="list-style-type: none"> • provides very limited structural stability until rooted • least suitable during active growing season • may rot and require extensive maintenance • construction is labour intensive 	<ul style="list-style-type: none"> • can be combined with other erosion control measures
Brush matting	<ul style="list-style-type: none"> • mattress-like layer of branches placed over slope to protect soil and slow water movement 	<ul style="list-style-type: none"> • provides bank protection and encourages vegetation regrowth • uses readily available, natural materials • can be conducted at time of construction. 	<ul style="list-style-type: none"> • least suitable during active growing season • construction is labour intensive • may accelerate erosion if not properly installed 	<ul style="list-style-type: none"> • can be combined with armoring and other methods
Silt fences (Dwg. No. 17)	<ul style="list-style-type: none"> • geotextile fence secured with steel rods on banks • may be used in conjunction with other techniques (e.g., straw bales) 	<ul style="list-style-type: none"> • minimizes slopewash into watercourse • easy to install 	<ul style="list-style-type: none"> • difficult to work around • requires periodic maintenance 	<ul style="list-style-type: none"> • temporary measure
Slope terracing	<ul style="list-style-type: none"> • benches are constructed on a slope to reduce overall slope load and gradient 	<ul style="list-style-type: none"> • reduces overall slope and gradient to minimize the potential of slope failure • aids in revegetation 	<ul style="list-style-type: none"> • requires additional work area • expensive and labour intensive 	<ul style="list-style-type: none"> • appropriate on constructed slopes where slope stability is more important than natural contours • not appropriate for most crossings
Live pole drains (Dwg. No. 21)	<ul style="list-style-type: none"> • bundles of willow branches securely tied partially buried in line with the fall line 	<ul style="list-style-type: none"> • provides natural drainage conduit • eventual establishment of willows helps stabilize soil and reduces water transport 	<ul style="list-style-type: none"> • labour intensive • only applicable in certain circumstances 	<ul style="list-style-type: none"> • not appropriate for steep slopes and/or large volumes of water • not appropriate for stabilization of slumping areas
Restoration of drainage channels	<ul style="list-style-type: none"> • removal of excess spoil from drainage channel to maintain natural hydrology 	<ul style="list-style-type: none"> • maintains natural channel and vegetation patterns • minimizes changes to downstream river users and potential aquatic habitat 	<ul style="list-style-type: none"> • reduces storage area for spoil at drainage may require additional adjacent areas • lost material inadvertently adds to siltation 	<ul style="list-style-type: none"> • appropriate for minor drainages which may not be flowing during construction

Table 5.1 Erosion Control Techniques, Cont'd

Technique	Description	Advantages	Disadvantages	Comments
III. POST CONSTRUCTION PHASE – FINAL CLEAN-UP				
Revegetation & cover crop	<ul style="list-style-type: none"> • seed by broadcasting, harrowing or drilling with a suitable mix of species • utilize a quick-growing annual or biannual to establish ground cover 	<ul style="list-style-type: none"> • establishes a root mat and vegetation layer to reduce soil erosion by wind and water • cover crop will establish before permanent cover 	<ul style="list-style-type: none"> • requires some time to establish a root mat and ground cover • native seed may be expensive or unavailable • poor quality seed mix may introduce noxious weed species • vegetation may require extensive efforts before establishing 	<ul style="list-style-type: none"> • verify seed mix composition and quality with appropriate regulatory agencies prior to application • fertilizers and / or organic mulch may or may not be recommended
Organic matting/mulch	<ul style="list-style-type: none"> • paper or wood fibre spread by hand or by hydro-spray equipment to supplement soil organics 	<ul style="list-style-type: none"> • provides long-term plant nutrition • improves overall quality of soil • if slope is seeded first, mulch provides cover and retains moisture 	<ul style="list-style-type: none"> • mulch and application method may be expensive • access for equipment may be restricted • requires special materials • may wash-off during periods of heavy rain if a tackifier is not added 	<ul style="list-style-type: none"> • may be needed on exposed mineral soil slopes to establish an organic layer • recommended for long-term revegetation projects • recommended for poor quality soils with or without a fertilizer
Rollback	<ul style="list-style-type: none"> • spread small diameter timber and slash over right-of-way and walk down with tracked equipment 	<ul style="list-style-type: none"> • provides micro-habitats for water and seed catchment • slows surface water and wind minimizing erosion • may also incorporate natural seed as well as organic material 	<ul style="list-style-type: none"> • slash volumes may be limited and salvage of merchantable timber may be required • may limit operations and maintenance access • may require extra right-of-way to permit storage during construction • may accelerate erosion if rollback is too large and not properly walked down 	<ul style="list-style-type: none"> • may be incorporated with most other forms of erosion control • not to be placed in watercourses • recommend seeding after walking down rollback

6 Habitat Mitigation and Compensation

Proponents are frequently confused about the distinction between mitigation and compensation. Habitat ‘mitigation’ is undertaken as a normal part of water crossing construction to prevent impacts on fish habitats and biota. In all cases, the first preference is to avoid potential effects on aquatic and riparian habitat, generally by modifying the route or crossing method. Where this is not possible, the next priority is to reduce potential negative effects through appropriate mitigation measures. These mitigation measures may include changes to project design and timing, environmental protection measures applied during construction, and restoration of riparian, bank and instream habitat disturbed by construction activities.

Habitat ‘compensation’ is undertaken by proponents to achieve ‘no net loss’ where crossing activities could cause a HADD. The need for compensation is determined as part of the *Fisheries Act* authorization process. Compensation is described more fully in Section 6.1 of this document.

Riparian, bank and instream habitat restoration and enhancement techniques are summarized in Section 6.2 of this document. ‘Restoration’ is undertaken to restore ecological function lost as a result of disturbance. ‘Enhancement’ is undertaken to improve the productive capacity or functional use of habitat. Restoration and enhancement techniques may be applied for both mitigation and compensation purposes.

6.1 Compensation

DFO defines compensation as “the replacement of natural habitat, increase in the productivity of existing habitat, or maintenance of fish production by artificial means in circumstances dictated by social and economic conditions, where mitigation techniques and other measures are not adequate to maintain habitats for Canada’s fisheries resources”. Cash in lieu of compensation is not acceptable.

Compensation is the least preferred option for addressing effects on fish habitat and is only considered when adequate mitigation is impossible or impractical. In these cases, where HADD is likely to occur (typically <10% of crossings reviewed by DFO), a proponent should request a Subsection 35(2) Authorization from DFO. The proponent is within its legal rights to proceed without getting this authorization. However, should this happen and HADD results, the proponent is liable to prosecution under the *Fisheries Act* if an Authorization is not in place.

The Subsection 35(2) Authorization allows a proponent to proceed under prescribed conditions, including the need to achieve ‘no net loss’ by compensating for adverse effects on fish habitat. However, even though a proponent may be willing to undertake compensation, issuance of a Subsection 35(2) Authorization with compensation specified is the least preferred option and may not be acceptable for particularly valuable fish habitat. Authorizations will

not normally be issued until adequate compensation measures are specified. Compensation measures may be set out directly in the Subsection 35(2) Authorization via reference in the Authorization or through legal agreement between the proponent and DFO. All costs associated with compensation are the responsibility of the proponent.

Proponents should consult with provincial, territorial and federal authorities and technical specialists before developing compensation measures to confirm that mitigation is not possible and that compensation is an acceptable option. Proponents will also need to demonstrate that proposed compensation measures are technically and economically feasible and appropriate for each crossing requiring an Authorization.

6.1.1 Compensation Plans

Any instruction, action, intervention, construction or undertaking to offset an unmitigated impact to fish habitat is considered an effort towards compensation. Habitat compensation is intended to improve physical, chemical, or biological factors that are limiting habitat capability. This includes replacing damaged habitat with newly created habitat, increasing the productive capacity of existing natural habitat, or least preferably, maintenance of fish production by artificial means. These must be identified on a crossing-by-crossing basis by the proponent, in consultation with technical specialists, as well as provincial, territorial and federal authorities. Local fisheries management plans should also be used, where they exist, to help determine appropriate compensation options.

A compensation plan is usually submitted by the proponent as part of a development proposal. DFO recommends that a Qualified Environmental Professional be used for advice and guidance in developing and implementing a compensation plan. DFO Pacific Region has recently provided a list of information requirements to include in a compensation plan on the DFO Pacific Region website in an effort to assist proponents working near water in BC and the Yukon. Some of the key items requested by DFO to include in a compensation plan are as follows; for a complete list, refer to the DFO Pacific Region website for Working Near Water (DFO 2010):

- outline of the objectives of the compensation plan and include type and amount of habitat compensation being proposed, fish species and stocks targeted, and linkage to fisheries management objectives;
- describe the compensation site and planned works including photographs and sketches/drawings of the site identifying the approximate location (geographic coordinates), area, number and dimensions of compensation works and structures;
- describe in detail the proposed compensation works including plans or drawings for any constructed works or structure, and drawings outlining the nature and location of compensation works;

- characterize the habitat gains expected from the compensation works (*i.e.*, the species that will benefit, the type and amount of habitat to be created, the time required for compensatory habitat to be fully functioning and the habitat functions that will be created, improved or enhanced);
- describe how the combination of compensation options and habitat ratios (amount of compensatory habitat vs. amount of affected habitat) selected will achieve ‘no net loss’ in productive capacity of fish habitats;
- identify any affected Aboriginal communities and stakeholder groups, and include consultation efforts;
- describe the monitoring that will be conducted to assess compliance with conditions of the authorization and effectiveness of both mitigation measures and compensation works and any other environmental inspection and monitoring commitments; and
- for additional items, refer to the DFO Pacific Region website for Working Near Water (DFO 2010).

6.1.2 Habitat Compensation Options

The Practitioners Guide to Habitat Compensation (DFO 2006a) provides the following hierarchy of preferences to compensate for affected habitat:

- create or increase the productive capacity of similar habitat (**like-for-like**) at or near the development site within the same ecological unit (*e.g.*, gravel placement; instream, bank and riparian habitat enhancement; removal of permanent fish passage obstructions for same species);
- create or increase the productive capacity of different habitat (**unlike**) in the same ecological unit (*e.g.*, gravel placement; instream, bank and riparian habitat enhancement; watershed restoration; removal of permanent fish passage obstructions);
- create or increase the productive capacity of a different ecological unit (**different**); and,
- measures of last resort (*e.g.*, artificial propagation and deferred compensation) (the least desirable option).

An ecological unit is defined as "populations of organisms considered together with their physical environment and the interacting processes amongst them". The ecological value of the existing habitat must be considered before moving down the hierarchy of compensation options.

In situations where site-specific issues are well understood and limitations to productive capacity are known, moving down the hierarchy of compensation may be justified when aligned with fisheries management objectives.

The selection of the most appropriate option or options will depend on the existing watershed conditions, life history of the species affected, factors limiting habitat productivity and technical feasibility and long-term success of restoration and enhancement options. Proponents should consult with provincial, territorial and federal authorities, technical specialists and knowledgeable public

representatives to identify appropriate compensation opportunities in or near the affected watercourse. It is important to take into consideration the regional fisheries management priorities or goals that may apply to the affected watercourse.

While proponents are responsible for achieving ‘no net loss’, in some situations there may be advantages for DFO and/or its partners to complete additional measures that would result in net gain of productive capacity at the habitat compensation site by taking advantage of background information and logistical support. An example would be where an area was identified as having potential for significant habitat enhancement that would be far in excess of the requirements to meet ‘no net loss’.

Note, however, that experience has shown that site-specific projects are much more likely to yield only short-term results, create habitat at the expense of other areas, or fail altogether, than projects that consider the entire watershed. Measures that deal directly with fundamental problems in catchments or watersheds are more beneficial over the long-term.

Restoration of Orphan Sites

The clean-up or restoration of altered, disrupted, or degraded habitats for compensation purposes is considered to be a useful practice and is generally encouraged. This option is applicable to any level in the compensation hierarchy. The restoration of orphan sites may be considered for sites with no known responsible owner, where the disturbance occurred with an outdated legal or policy framework, and where legal and liability agreements can be reached. Compensation should be consistent with local fish management plans where they exist, and partner agency objectives should be considered.

Restoration as compensation is not appropriate at ‘non-orphaned sites’, since these should be cleaned up by the responsible party/owner. Neither should it be considered when government is investing in or financing the cleanup.

Habitat Banking

Habitat banking occurs when a proponent creates or improves fish habitat for future use as compensation (*i.e.*, prior to an authorization being issued). The location and design of a habitat bank must first be approved by DFO and proponents must provide data describing the ‘before’ conditions before habitat banking work is begun.

Habitat banking sites should be worthy of restoration or enhancement, land ownership and access should be clear, and all required permits must be in place. Habitat banks are useful in situations where a proponent needs to compensate for several small HADDs, and few compensation options exist at the site(s). Habitat banking may have the benefit of requiring smaller replacement ratios, since effectiveness is already known. During the time between the creation of the new

habitat and its use as compensation, fish benefit from the existence of the habitat bank and a net gain of productive capacity occurs.

The creation of a habitat bank does not ‘pre-approve’ any future HADDs since all projects will be reviewed on their own merits. The use of a habitat bank is considered at the request of the proponent, but all on-site compensation options must be explored before using the habitat bank. A habitat bank must be evaluated immediately prior to its use as compensation to ensure that the bank is functioning properly and determine its value relative to original conditions. If only a portion of the bank is to be used in any given year, it is important to document what part of the bank is still available for use as future compensation. If the productive capacity of any bank or part thereof increases after it has been used as compensation, this increase will not be considered additional banked habitat.

6.1.3 Determining the Amount of Compensation Required

The amount of compensation must be determined based on the residual net loss of productive capacity after relocation, redesign and mitigation have been taken into consideration. Compensation usually requires a compensation ratio that exceeds 1:1 to ensure that ‘no net loss’ occurs, allowing for time lags and uncertainty of success. Lower ratios are acceptable where compensation works are completed and functional before habitat loss occurs. In most cases, replacement ratios increase as the proponent moves down the compensation hierarchy and certainty of ‘no net loss’ decreases. Appropriate scientific tools are generally used to determine appropriate compensation ratios (*e.g.*, Minns 1995, 1997; Minns *et al.* 1995, 1996; Portt *et al.* 1999, Quigley and Harper 2005a,b).

6.1.4 Compliance and Effectiveness Monitoring of Compensation

Compensation is monitored through compliance monitoring and effectiveness monitoring. Compliance monitoring ensures that the habitat compensation measures outlined in the authorization are followed and implemented. Refer to the DFO habitat compliance decision framework (DFO 2007a) for additional information. Effectiveness monitoring ensures the habitat compensation measures are functioning and will function as intended over the long-term in regards to ‘no net loss’ of the productive capacity of fish habitat.

The Practitioners Guide to Habitat Compensation (DFO 2006a) includes a section on monitoring listing the following requirements for monitoring: baseline information; an assessment of the completed compensation including photographs; and a reporting and maintenance program. If the habitat compensation measures do not comply and are not functioning, DFO can require the proponent to make adjustments and/or implement contingency plans. DFO also determines the duration of the monitoring and it is usually based on the complexity or uncertainty of the works.

6.2 Mitigation and Compensation Techniques

Habitat protection, restoration and enhancement of aquatic and riparian habitat may be conducted in conjunction with pipeline crossings to avoid or compensate the effect of construction activities. Riparian habitat refers to the unique vegetation community found between a waterbody and the surrounding upland. This vegetation develops on banks, floodplains and wetlands with soils that are wet during some portion of the growing season (Meehan 1991). These riparian areas support diverse migratory bird, wildlife and plant communities, and are an important component of aquatic habitat because they provide food, shade and cover, and help stabilize streambanks.

Habitat restoration and enhancement are most frequently undertaken in sensitive streams with species that are rare, at risk, or of recreational, economic, subsistence, or scientific interest. A variety of protection, restoration and enhancement techniques are available and qualified specialist advice should be obtained to identify what effects could occur, what mitigation is required and to select the most appropriate method or combination. Specific procedures are described for bank and riparian habitat in Section 6.2.1 of this document and instream habitat in Section 6.2.2 of this document. The selection of a particular technique depends largely on the existing site conditions including stream hydrology, bank stability, icing conditions, soils, surrounding vegetation and reasons for observed damage or limited productive capacity.

It is also necessary to understand how the restored watercourse will function once work is completed, the maintenance requirements of any structures, the life expectancy of materials used and any problems that could be created. This understanding will help ensure that aquatic and riparian habitat is protected or enhanced in a way that minimizes future costs and impacts.

Considerable cost savings can be realized by using equipment and local materials that are already available at the time of construction. In some cases, however, rehabilitation and enhancement work will need to be conducted at a different time than pipeline installation.

Ideally, proponents should consider their long-term development plans and identify opportunities for sequential or co-operative restoration and enhancement programs within a watershed. Experience has shown that site-specific projects are much more likely to yield only short-term results or fail altogether than projects that consider the entire watershed.

Where work is not undertaken by professionals under an established Code of Practice, proponents should consult with the local or regional fisheries biologist, regional DFO representative, other regulatory agencies, qualified technical specialists and public representatives to identify the most appropriate mitigation and compensation procedures. In all cases, proponents must ensure that necessary approvals are obtained for proposed protection, restoration and enhancement work.

6.2.1 Bank and Riparian Habitat Restoration and Enhancement

Bank and riparian habitat is directly affected by grading and clearing, and may also be indirectly affected by changes in surface and groundwater flow patterns, or through trampling, grazing and erosion where animals and recreational users utilize the right-of-way. Disturbance of riparian and bank areas can result in direct and indirect effects on water quality, water temperature, channel patterns, as well as fish and wildlife habitat availability and productivity.

Restoration or stabilization of streambanks may be required to minimize erosion or undertaken to restore or enhance nearshore fish habitat for compensation purposes. Streambank erosion is a concern where sediment is deposited in downstream habitats such as spawning, rearing and overwintering areas. Special care should be exercised in stabilizing the outside bends of streams, since such areas are subject to greater erosion pressures. The following additional issues or concerns are associated with water crossing construction in riparian areas:

- riparian habitat may be directly affected by siltation resulting from pipeline construction activities; and
- water quality may also be indirectly affected by changes in surface and groundwater flow patterns resulting from pipeline construction, or through trampling, grazing and erosion where animals and recreational users utilize the right-of-way.

A variety of site-specific and watershed management techniques are available to restore or enhance riparian and bank areas. Site-specific techniques are summarized in Table 6.1; appropriate Drawings are also referenced. Proponents should consult with technical specialists and public representatives to identify appropriate watershed restoration and enhancement procedures such as riparian fencing or public awareness.

At typical watercourse crossings where the banks are graded to a low angle, nearshore rearing and holding habitat is limited following completion of construction. Natural materials such as boulders (riprap and rock armouring), root balls and trees placed or anchored on streambanks can enhance nearshore habitat by providing hiding and resting places for juvenile and adult fish. The objectives of these methods are to provide economical, short- to long-term bank stabilization structures with a natural appearance and relatively low maintenance requirements.

Methods that increase the angle of the bank can also be installed. These include: fibre and grass rolls; logwalls and cribwalls; overhangs and lunker structures; brush layering, matting and bundles; tree revetments; and shrub planting and transplants. The objectives of these methods are to increase nearshore depth and encourage development of self-sustaining, overhanging plant cover. Many of these structures have a limited life span, so they should be designed to encourage natural bank development. Biodegradable products should be used whenever possible.

A long-term monitoring and maintenance program should be initiated to maintain the integrity of riparian and bank restoration and enhancement projects (Section 7.2 of this document).

6.2.2 Instream Habitat Restoration and Enhancement

The key characteristic of productive instream habitat is diversity. When properly used, instream structures and techniques can restore or enhance important or critical features such as spawning and food producing areas, cover and overwintering habitat. Spawning areas must provide a suitable environment during the egg laying, incubation and fry emergence periods. Food producing areas have substrate, depth and flow conditions that support aquatic invertebrates and forage fish. Instream cover provides fish protection from high current velocities and predators. Overhanging vegetation, undercut banks, submerged objects, depth and water turbulence provide cover (Wesche 1985).

A variety of site-specific and watershed management techniques are available to restore or enhance instream habitat. A general discussion of site-specific instream restoration and enhancement techniques is provided below. Additional information is summarized in Table 6.2 and Drawings are provided in Appendix A. Note that care must be taken to select suitable techniques, particularly for instream enhancement. Experience has shown that installation of 'enhancement' features that do not adequately reflect natural waterbody hydrology or ecology can create unwanted and undesirable long-term effects.

Removal of permanent obstructions to fish passage is an effective technique used to compensate for HADD. Instream barriers and debris can be natural (beaver dams, rocks, woody debris, falls) or man-made (garbage, culverts). Removal of barriers to fish movement can restore watershed connectivity by providing access to suitable spawning and rearing areas. Instream debris and barriers can slow streamflow, causing sediment deposition, increased water temperature and erosion where the debris redirects stream flow. Since natural barriers and debris also provide cover and overwintering habitats, technical specialists should be involved to determine whether these structures are beneficial or damaging habitat. Care should also be taken to ensure that removal of barriers or debris does not result in unintended effects on downstream habitat.

Bank rehabilitation and enhancement measures such as boulders, root balls, tree revetments, cribwalls and overhangs described in the previous subsection also provide or improve instream habitat for juvenile and adult fish. Logs, boulders, root balls and trees can also be placed in the stream channel to provide lateral and overhead cover and rearing habitat, establish meanders or pools and protect eroded banks.

Current deflectors are one of the most commonly used structures to manipulate instream habitat. They are relatively inexpensive and easy to construct and can: be built from a variety of materials; be adapted to site conditions and a variety of

stream sizes; be used in conjunction with other techniques; and fulfill more than one purpose. Deflectors can be built to: direct currents to desired locations; develop meander patterns; deepen and narrow channels; deepen pools and scour sediment; increase water velocities; keep flow out of side channels; encourage silt bar formation; maintain low water temperatures; and enhance pool-riffle ratios. Technical specialists should be involved to ensure that unwanted effects do not occur.

Current deflectors can be constructed of logs, rocks, boulders, gabions or various combinations of these materials. These structures are typically angled downstream and include triangular and peninsular shapes (wing deflectors and groynes, respectively). Structure height is generally determined from low flow conditions. Double-wing deflectors combining two current deflectors on opposite banks can also be used in larger streams to narrow the channel.

Low profile dams and weirs are multipurpose structures created from a variety of materials. Overpour structures are used to create pool habitat, raise water levels and collect and hold spawning gravel. They are most often used on small, high gradient streams and are relatively inexpensive, although construction is labour intensive. Their success depends on proper siting and construction; technical specialists should be involved to ensure that unwanted effects do not occur.

Substrate manipulation can be used in both warm- and cold-water habitats and includes placement or capture of suitable spawning materials and excavation of runs and pools. In streams with a natural bedload of granular spawning substrates, instream structures such as current deflectors, weirs and dams may be placed so that granular material is deposited and retained in suitable locations. Spreading clean gravel, especially when already used to construct dams for isolated watercourse crossings, can create spawning habitat if channel characteristics are appropriate. In streams with unstable flows or periodic flooding, catchment devices may be required to stabilize spawning substrates.

Proponents should consult with technical specialists and public representatives to identify appropriate watershed restoration and enhancement procedures. These procedures may include: road deactivation and rehabilitation; corridor fencing programs to protect waterbodies; sediment interception and retention; and public education programs to promote awareness of fisheries as well as fish habitat conservation and protection.

Instream structures have a limited life span and are susceptible to damage by floods and ice. A long-term monitoring and maintenance program should be initiated to maintain the integrity of restoration and enhancement projects and minimize unanticipated or unintended damage (Section 7.2 of this document). In addition, instream habitat restoration and enhancement may create an impediment to navigation. Before any structures are installed, proponents should contact TC to ensure no concerns exist or the correct approvals are obtained.

Table 6.1 Bank Restoration and Enhancement

Description	Advantages	Disadvantages	Comments
BOULDER PLACEMENT AND BANK ARMOURING (Dwg. No. 23)			
<ul style="list-style-type: none"> Riprap or boulders placed on bank. Can be combined with geotextiles to prevent undercutting and erosion. 	<ul style="list-style-type: none"> Stable at almost all flow levels. Very durable; low upkeep. Simple to install. Provides instream cover and macro-invertebrate habitat. 	<ul style="list-style-type: none"> Requires heavy machinery. Unnatural appearance. Suitable material may not be readily available. 	<ul style="list-style-type: none"> Suitable for all watercourses with coarse bottoms. Proper placement is critical to avoid undesired effects. Can be used in combination with most other techniques.
TREE REVETMENTS AND ROOT BALLS (Dwg. Nos. 24, 32)			
<ul style="list-style-type: none"> Clean root balls or woody material anchored into streambanks. Conifers anchored into streambanks with branches intact and butt end upstream. 	<ul style="list-style-type: none"> Installation is relatively easy and inexpensive. Provides immediate cover and rearing habitat, bank stability, and sediment collection. May also be used to improve channel conditions (pool-riffle ratio; meanders) and protect eroding outside bends. Natural appearance. 	<ul style="list-style-type: none"> Can be washed away or damaged by high flows and ice. May not provide long-term stability or habitat. Tree revetments may be considered unsightly as needles fall off. Stabilization of opposite bank may be required. 	<ul style="list-style-type: none"> Most suitable in low to moderate gradient watercourses. Trees should be largest available. Can be used in combination with rock clusters for additional protection.
GABIONS AND SHEET PILING (Dwg. No. 25)			
<ul style="list-style-type: none"> Rock-filled wire or plastic baskets anchored into streambank. Sheet piling anchored in streambank. 	<ul style="list-style-type: none"> Provides long-term stability for bank and slope toe. Can be used on steep slopes or where suitable riprap material is not available. Simple to construct. 	<ul style="list-style-type: none"> Expensive and labour intensive. Usually requires heavy machinery. Baskets can deteriorate, leaving unsightly and unsafe wire ends. Difficult to repair if undermined. Unnatural appearance. Susceptible to erosion at upstream end if improperly installed. 	<ul style="list-style-type: none"> Riprap generally preferred on shallow to moderate slopes. Appearance can be enhanced with sod or superficial brush / shrub layering.
FIBRE COIR LOGS AND GRASS ROLLS (Dwg. Nos. 26, 27)			
<ul style="list-style-type: none"> Fibre coir logs - biodegradable logs constructed of interwoven coconut fibres. Grass rolls - clumps of sod bound tightly into a sausage shape with burlap. Holes cut to expose shoots. 	<ul style="list-style-type: none"> Provides temporary stability for bank and slope toe. Provides growth medium. Do not require heavy equipment for installation. 	<ul style="list-style-type: none"> Susceptible to dislodging. May not provide long-term stability or habitat. Labour intensive. 	<ul style="list-style-type: none"> Most suitable as temporary solution to allow vegetation to become established. Most suitable for small waterbodies with low banks. Slow, low gradient watercourses

Table 6.1 Bank Restoration and Enhancement, Cont'd

Description	Advantages	Disadvantages	Comments
LIVE STAKING AND TRANSPLANTS (Dwg. No. 28)			
<ul style="list-style-type: none"> Planting of individual dormant cuttings. Transplanting individual plants or sod from immediate area or nursery stock. 	<ul style="list-style-type: none"> Uses readily available, native materials. High success rate with proper species and procedures. Transplanted shrubs and trees can provide immediate cover. Provides both aquatic and terrestrial habitat. 	<ul style="list-style-type: none"> Unsuitable for dry soils. Large projects may require material from multiple sites. Heavy machinery required to transplant large shrubs and trees. Suitable nursery stock may not be available or economic. Many transplants do not survive as they are eaten by wildlife and cattle. 	<ul style="list-style-type: none"> Cuttings should be dormant; most successful in early spring. Watering can increase survival. Stakes may be used to anchor brush bundles, brush mattresses and erosion control blankets. Obtain permission if transplants are to be taken from off right-of-way.
LOGWALLS AND CRIBWALLS (Dwg. No. 29)			
<ul style="list-style-type: none"> Logwall - a log retaining wall installed to create a vertical bank. Held in place with vertical pilings. Cribwall - a logwall with a system of offset cross logs that anchor the structure. 	<ul style="list-style-type: none"> Maintains nearshore stream depth, bank slope and provides erosion control. Less expensive than rock structures. Long-term protection if well maintained. Provides some overhead cover for fish. Will deteriorate over time to restore 'natural' bank. 	<ul style="list-style-type: none"> Requires heavy machinery and ongoing maintenance. Somewhat artificial appearance. Time consuming and labour intensive. Structure deteriorates over time (e.g., 3 years untreated wood, 12 years treated wood). 	<ul style="list-style-type: none"> Most suitable in watercourses with eroding banks, stable channel and flows with low to moderate gradient. Structure will last longer if all wood is submerged. Can be used in series.
BRUSH LAYERING (Dwg. No. 30)			
<ul style="list-style-type: none"> Fill slopes consisting of alternating layers of soil and live branches. Brush layers of criss-crossed branches angled into slope. Can be combined with geotextiles on steep slopes. 	<ul style="list-style-type: none"> Provides erosion control and overhanging cover almost immediately. Uses readily available, natural materials. Can be conducted at time of construction. Provides terrestrial habitat. 	<ul style="list-style-type: none"> Least suitable during active growing season. Construction is labour intensive. 	<ul style="list-style-type: none"> One of best techniques for stabilizing slopes and streambanks. Can be combined with armoring and other methods.
LIVE SILTATION			
<ul style="list-style-type: none"> bury branches along high water mark and backfill with rock 	<ul style="list-style-type: none"> Promotes silt entrapment along bank. Produces bank protection and overhead cover. Relatively easy to construct. 	<ul style="list-style-type: none"> Least suitable during active growing season. Construction is labour intensive. 	<ul style="list-style-type: none"> Can be combined with other erosion control measures.

Table 6.1 Bank Restoration and Enhancement, Cont'd

Description	Advantages	Disadvantages	Comments
BRUSH BUNDLES, FASCINES OR WATTLES			
<ul style="list-style-type: none"> • Bundles of live cuttings tied to produce sausage shaped bundles. • Planted in shallow trenches anchored with wooden or live stakes. 	<ul style="list-style-type: none"> • Can be used to direct or slow water movement and encourage vegetation growth on bank. • Don't require heavy equipment for installation. 	<ul style="list-style-type: none"> • Provides very limited structural stability. • Least suitable during active growing season. • May rot and require extensive maintenance. • Construction is labour intensive. 	<ul style="list-style-type: none"> • Can be combined with other erosion control measures.
BRUSH MATTING			
<ul style="list-style-type: none"> • Mattress-like layer of branches placed over slope to protect soil and slow water movement. 	<ul style="list-style-type: none"> • Provides bank protection and encourages vegetation regrowth. • Uses readily available, natural materials. • Can be conducted at time of construction. 	<ul style="list-style-type: none"> • Least suitable during active growing season. • Construction is labour intensive. 	<ul style="list-style-type: none"> • Can be combined with armouring and other methods.
EXCLUSION FENCING			
<ul style="list-style-type: none"> • Installation of fences to exclude livestock and vehicles. 	<ul style="list-style-type: none"> • Prevents trampling, rutting and erosion. • Allows natural growth or recovery of riparian vegetation and banks. • Most effective technique to restore banks or watercourses damaged by livestock. 	<ul style="list-style-type: none"> • Relatively expensive and labour-intensive. • Requires landowner agreement. • Ongoing inspection and maintenance. 	<ul style="list-style-type: none"> • Fence should be set back far enough to allow for vegetation growth and lateral channel movement. • Livestock watering and crossing sites may be necessary.

Table 6.2 Instream Habitat Restoration and Enhancement Techniques

Description	Advantages	Disadvantages	Comments
INSTREAM COVER Rock Clusters (Drawing No. 31)			
<ul style="list-style-type: none"> Boulder groupings placed on streambed. 	<ul style="list-style-type: none"> Simple and effective technique to provide overhead and lateral cover and rearing habitat. May also be used to improve channel conditions (pool-riffle ratio; meanders) and catch granular materials. Natural appearance. Inexpensive materials. 	<ul style="list-style-type: none"> Suitable material may not be readily available. Requires heavy equipment. Improper placement may cause bank erosion by altering streamflow dynamics. Can catch instream debris if not installed properly and create risk of erosion. 	<ul style="list-style-type: none"> Proper placement is critical to avoid undesired effects. Can be used in combination with most other techniques.
INSTREAM COVER Tree Revetments and Root Balls (Drawing Nos. 24, 32)			
<ul style="list-style-type: none"> Clean root balls anchored into streambanks or streambed. Conifers anchored into streambanks with branches intact with butt ends upstream. 	<ul style="list-style-type: none"> Installation is relatively easy and inexpensive. Provides immediate cover and rearing habitat, bank stability, and sediment collection. May also be used to improve channel conditions (pool-riffle ratio; meanders). Natural appearance. 	<ul style="list-style-type: none"> Can be washed away by high flows and ice. May not provide long-term stability or habitat. Tree revetments may be considered unsightly as needles fall off. May require stabilization of opposite bank. Can catch instream debris if not installed properly and create risk of erosion. 	<ul style="list-style-type: none"> Most suitable in low to moderate gradient watercourses. Can be used in combination with most other techniques.
INSTREAM COVER Submerged cover (Drawing No. 33)			
<ul style="list-style-type: none"> Submerged log or log slab secured in watercourse to provide cover. Submerged artificial cover such as swamp weights or irrigation chute. 	<ul style="list-style-type: none"> Inexpensive and easy to install or adjust. Can be used as temporary or permanent structure. Logs have natural appearance. 	<ul style="list-style-type: none"> Not effective in watercourses with wide fluctuations in flow. Can catch instream debris if not installed properly and create risk of erosion. Artificial cover has unnatural appearance. 	<ul style="list-style-type: none"> Most suitable in small to medium sized watercourses with low to moderate gradient and not subject to extreme flooding or ice damage. Can be used in combination with most other techniques. Natural cover materials preferred.

Table 6.2 Instream Habitat Restoration and Enhancement Techniques, Cont'd

Description	Advantages	Disadvantages	Comments
BANK COVER Logwalls and Cribwalls (Drawing No. 29)			
<ul style="list-style-type: none"> Logwall - a log retaining wall installed to create a vertical bank. Held in place with vertical pilings. Cribwall - a logwall with a system of offset cross logs that anchor the structure. 	<ul style="list-style-type: none"> Maintains nearshore watercourse depth. Less expensive than rock structures. Long-term protection if well maintained. Provides some overhead cover for fish. Will deteriorate over time to restore 'natural' bank. 	<ul style="list-style-type: none"> Requires heavy machinery and ongoing maintenance. Somewhat artificial appearance. Time consuming and labour intensive. Structure deteriorates over time (e.g., 3 years untreated wood, 12 years treated wood). 	<ul style="list-style-type: none"> Most suitable in watercourses with eroding banks, stable channel and flows and low to moderate gradient. Structure will last longer if all wood is submerged. Can be used in series.
BANK COVER Bank Overhangs (Drawing No. 34)			
<ul style="list-style-type: none"> Artificial overhang of concrete, timber, or gabion baskets tied into streambank. Can be covered and revegetated. 	<ul style="list-style-type: none"> Provides stable overhead cover and offers some bank protection. Confines streamflow. Natural appearance once revegetated. 	<ul style="list-style-type: none"> Construction is labour intensive and can be costly. If current is diverted, downstream bank stabilization may be necessary. Not durable in large watercourses. Can be damaged by ice. 	<ul style="list-style-type: none"> Most suitable in watercourses with stable channel and flows and low to moderate gradient. Structure will last longer if all wood is submerged. Can be used in series or placed opposite deflectors to scour out a pool under the cover. Should not extend beyond natural stream bank to prevent downstream erosion.
BANK COVER Wing Deflectors (Drawing Nos. 35, 36)			
<ul style="list-style-type: none"> Triangular structures made of rock or logs that create a narrower, deeper channel with increased flow velocity. 	<ul style="list-style-type: none"> Can help keep downstream areas free of sediments. Can produce cover by scouring pools and creating undercut banks. 	<ul style="list-style-type: none"> Can be costly and require heavy equipment. Can cause erosion problems and bank instability. Downstream bank stabilization may be necessary. Unnatural appearance. 	<ul style="list-style-type: none"> Proper placement is critical. Most suitable in watercourses with low to moderate gradient, especially wide, slow flowing reaches. Can be used in series or combination with cover on opposite bank. Contact DFO to determine if <i>Fisheries Act</i> Authorization is required.

Table 6.2 Instream Habitat Restoration and Enhancement Techniques, Cont'd

Description	Advantages	Disadvantages	Comments
BANK COVER Groynes (peninsular deflectors) (Drawing No. 37)			
<ul style="list-style-type: none"> Peninsular structures made of rock that are used to redirect flow. 	<ul style="list-style-type: none"> Can help keep downstream areas free of sediments. Can produce cover by scouring pools and creating undercut banks. Provides fish habitat. More effective than continuous bank protection. 	<ul style="list-style-type: none"> Can cause erosion problems and bank instability. Downstream bank stabilization may be necessary. Unnatural appearance. During high flows, results in severe erosion downstream of groyne. 	<ul style="list-style-type: none"> Proper placement is critical. Most suitable in watercourses with low to moderate gradient, especially wide, slow flowing reaches. Can be used in series or combination with cover on opposite bank. Contact DFO to determine if <i>Fisheries Act</i> Authorization is required.
OVERPOUR STRUCTURE Dams (Drawing Nos. 38, 39)			
<ul style="list-style-type: none"> Low profile dams constructed of rock or logs. Log structures include single log dam, K-dam, wedge dam, and plank dam. 	<ul style="list-style-type: none"> Provides resting habitat and plunge pools in high gradient waters. Can retain gravel. Aesthetically appealing. May increase dissolved oxygen. 	<ul style="list-style-type: none"> Construction is labour intensive and relatively expensive. May block sediment transport, filling in area above dam. Unstable at high flows. Failure and high liability. 	<ul style="list-style-type: none"> Proper placement is critical. Moderate to high gradient watercourses with stable flows where significant impoundment will not occur. Contact DFO to determine if <i>Fisheries Act</i> Authorization is required.
OVERPOUR STRUCTURE V-Weir (Drawing Nos. 40, 41)			
<ul style="list-style-type: none"> Log or rock structures placed in a V shape across the watercourse. 	<ul style="list-style-type: none"> Can create pool habitat, cover and retain gravel. Economical. 	<ul style="list-style-type: none"> Can cause erosion problems and some bank instability. Requires heavy equipment. 	<ul style="list-style-type: none"> Proper placement is critical. Most suitable in small watercourses with low gradient. Contact DFO to determine if <i>Fisheries Act</i> Authorization is required.
SUBSTRATE MANIPULATION Gravel Placement			
<ul style="list-style-type: none"> Clean gravel placed on streambed. Minimum depth is 1.0-1.8 m. 	<ul style="list-style-type: none"> Clean gravel may be used during construction for dams and crossing structures. Economical. 	<ul style="list-style-type: none"> Temporary. Suitable material may not be readily available. Requires heavy equipment. Over time, gravel may be readily washed downstream or filled with sediment. 	<ul style="list-style-type: none"> Most suitable in small to medium watercourses with low to moderate flow and low sediment load.

Table 6.2 Instream Habitat Restoration and Enhancement Techniques, Cont'd

Description	Advantages	Disadvantages	Comments
SUBSTRATE MANIPULATION Excavated Pool, Run (Drawing Nos. 42, 43)			
<ul style="list-style-type: none"> Artificial pool or run excavated in streambed with heavy equipment. 	<ul style="list-style-type: none"> Immediate resting habitat and cover. 	<ul style="list-style-type: none"> Excavated areas fill easily with transported sediment from run-off. Temporary. Requires heavy equipment. 	<ul style="list-style-type: none"> Most suitable in small to medium watercourses with low sediment transport capability. May be used in combination with bank cover or current deflectors. Approval required.
SUBSTRATE MANIPULATION Gravel Cleaning			
<ul style="list-style-type: none"> Cleaning of spawning gravel by vacuuming, mechanical scarification or hydraulic flushing. 	<ul style="list-style-type: none"> Immediate improvement in gravel quality for spawning and aquatic invertebrates. 	<ul style="list-style-type: none"> Most techniques require heavy machinery. Fine sediments washed downstream may degrade habitat and water quality. Aquatic invertebrate production in cleaned area may decline. Temporary. 	<ul style="list-style-type: none"> Employed primarily in spawning channels or lake tributaries. Limited application in natural watercourses because of potential for downstream effects.
DAMS AND DEBRIS Debris Removal			
<ul style="list-style-type: none"> Removal of rocks, trash or woody debris that are damming or blocking the stream channel. 	<ul style="list-style-type: none"> Can restore channel patterns and provide access to upstream spawning or rearing habitat. 	<ul style="list-style-type: none"> Can reduce habitat quality if poorly implemented. 	<ul style="list-style-type: none"> N/A
DAMS AND DEBRIS Culvert Repair			
<ul style="list-style-type: none"> Repair or replacement of existing culverts that are barriers to fish movement. 	<ul style="list-style-type: none"> Can restore channel patterns and provide access to upstream spawning or rearing habitat. 	<ul style="list-style-type: none"> Constant inspection and maintenance may be necessary. High maintenance. 	<ul style="list-style-type: none"> Repair or replacement can be effective compensation technique. Possible 'band-aid' solution if culverts are inappropriate in the first place.
DAMS AND DEBRIS Beaver Management			
<ul style="list-style-type: none"> Permanent beaver dam removal or opening passages in dams during critical periods. 	<ul style="list-style-type: none"> Can provide access to upstream spawning or rearing habitat. 	<ul style="list-style-type: none"> Constant inspection and dam removal may be necessary. High maintenance. 	<ul style="list-style-type: none"> Most beaver dams are best left in place. Beaver dam removal requires approval in most provinces.

7 Monitoring Crossing Project Performance

In sensitive watercourses, or where there is concern regarding impacts on fish or fish habitat, specific watercourse crossing objectives may be specified prior to construction. As discussed in Section 1.3 of this document, proponents are also advised to develop corporate or project-specific watercourse crossing objectives for inclusion in environmental protection plans, bid documents and regulatory applications. These crossing objectives may be based on existing legislation, fisheries management objectives for the area or discussion with appropriate regulatory authorities, and could include measurable water quality values or biophysical criteria or thresholds. Construction-related objectives could include duration, location or quantity of instream and riparian construction activities.

Objectives will depend on the watercourse being crossed, the species and habitat present, and the time of construction. For example, protection of spawning and incubating habitat will be of primary importance for a crossing proposed during the spawning period. In this case, objectives could specify appropriate flow levels and suspended sediment concentrations, or maintenance of desirable substrate characteristics during the spawning and incubation period.

Section 35 of the *Fisheries Act* refers solely to fish habitat, but DFO's *Policy for the Management of Fish Habitat* makes the link between habitat and productive capacity. Changes to productive capacity are not normally measured or estimated directly. Rather, the inferred change in productive capacity is based on an understanding of how physical, chemical and biological attributes describe habitat. Changes in these attributes are used as an indicator of changes in habitat and ultimately, productive capacity.

Guidance on performance attributes, criteria and objectives can be obtained from:

- existing water quality standards (e.g., Canadian Council of Ministers of the Environment Water Quality Guidelines 2007);
- model outputs (e.g., sediment dose models described in Anderson *et al.* 1996);
- construction monitoring programs; and
- specialist advice from aquatic scientists.

Once crossing objectives have been specified, construction inspection and monitoring and post-construction monitoring programs should be designed to evaluate crossing success (see Sections 7.1 and 7.2 of this document).

To identify opportunities where cost or risk can be minimized with no adverse biophysical effects, crossing success should be evaluated both after construction and after post-construction monitoring results are available. Ideally, all parties should be involved in these reviews, including: project managers; onsite inspection staff; environmental staff; contractors; technical specialists; and regulators.

7.1 Environmental Monitoring During Construction

7.1.1 Environmental Inspection

Environmental inspection of construction at watercourse crossings by the proponent is recommended on all watercourses that are rated as having medium or high sensitivity. Inspection during construction on low sensitivity water crossings may be incorporated as part of the construction inspection.

Environmental inspection should be performed to ensure that the mitigation measures warranted at the crossings are implemented in a manner that minimizes the adverse environmental effects of construction. Environmental protection planning is of little value if the protection measures are ignored or poorly implemented during construction. It is critical that inspection start prior to the initial right-of-way preparation to prevent any mistakes early in the construction sequence. Environmental inspectors should have the appropriate authority to take corrective action as warranted including suspending an activity until the contractor complies with approvals or until approval from the appropriate government agency is obtained.

Inspectors should be chosen on the basis of their understanding of environmental requirements, knowledge of construction techniques and ultimately, their ability to integrate the two in the field and under pressure. Inspectors who cannot practically apply their environmental training or deal with the contractors will not likely last long on a construction spread. Inspectors with little environmental training may not make the correct decisions under pressure since they may not have the academic knowledge required to support their decisions. Finally, inspectors need capable contacts in the office that can research or support their decisions when they need assistance in making a decision while in the field.

Roles of the inspectors include ensuring that the following is undertaken:

- all acts, regulations and permits are in place and followed;
- procedures and contingencies are in place including all equipment and back-up equipment;
- siltation and sedimentation are controlled along all segments of the watercourse;
- crossing is completed as quickly as possible; and
- the environment is protected.

Collection of monitoring data during construction allows effects on water quality, habitat, fish and other animals to be documented. This information can help to:

- provide feedback to construction staff;
- confirm the effectiveness of protection measures;
- fulfill legal requirements;
- provide evidence of compliance; and
- validate scientific predictions.

Over time, use of a standardized monitoring procedure will help develop a data set that can be used to validate impact predictions, improve predictive models and help select the most appropriate construction methods. One or more of the following environmental variables may be monitored during construction, depending on the concerns and crossing objectives:

- suspended sediment load before, during and after construction to provide feedback to construction personnel and document the zone of influence and changes in water quality;
- substrate composition before, during and after construction to document areas of sedimentation;
- biological monitoring, including abundance, density and community composition before, during and after construction;
- watercourse flows during construction to ensure that fish passage and minimum flows are maintained; and
- monitoring during blasting and diversion procedures.

The location and number of sampling locations will be a function of the anticipated zone-of-influence. The zone-of-influence can be predicted using sediment deposition models or estimated based on the size and channel characteristics of the watercourse being crossed.

7.1.2 Suspended Sediment Load

Monitoring of suspended sediment load is one of the common instream construction monitoring techniques and usually combines field monitoring of stream discharge and turbidity (a measure of transparency of the water column) with laboratory analysis of TSS and settleable solids concentrations. An empirical turbidity-TSS relationship is then derived, so that turbidity measurements can be used as an indicator of actual TSS and settleable solids levels (see Anderson *et al.* 1996). The presence of critical habitats may justify inclusion of additional sample sites, transects or other water quality parameters.

The determination of an empirical relationship may not always be possible solely based on field data. Such is the case for systems with low background levels of TSS or low levels of variability (*e.g.* high elevation streams). A synthetic relationship determined in a lab setting with site specific materials may need to be used. This relationship would need to be refined and validated with real time data as it becomes available through monitoring.

Water quality monitoring can be designed to detect elevated levels of TSS resulting from instream construction activities. Factors considered when determining the most appropriate monitoring program can vary among the types of instream works, but commonly include a consideration of materials used and existing conditions at and adjacent to a work site. The purpose of water quality monitoring are to increase the potential for early warning of a potentially harmful elevation of TSS resulting from instream work; to assist in adjusting instream

activities in response to monitoring response to minimize the potential impact of sediment mobilizations; and help document the duration and magnitude of impacts should exceedances to an established threshold of TSS concentrations occur.

Established quantitative water quality guidelines for TSS and turbidity (*e.g.*, CCME 2007) are based on chronic exposure data, these guidelines do not represent a realistic objective for short-term instream activities because these long-term, low concentration standards may not be applicable to short-term high concentration events such as those associated with pipeline crossings. Consequently, some specialists have applied sediment-dose models to establish water quality objectives and evaluate actual effects. These models (*e.g.*, Newcombe and MacDonald 1991; Shen and Julien 1993; Anderson *et al.* 1996) predict effects on fish based on the duration and concentration of the sediment event, rather than a pre-established TSS/turbidity threshold.

A single suspended sediment load monitoring protocol has not been accepted due to the number of factors that affect sediment generation and transport, and the influence of site-specific conditions. Qualified specialists should be involved to design a suspended sediment monitoring program, however, the following discussion outlines some factors to be considered (see for example MacDonald and Bjornson 1993; Anderson *et al.* 1997; Clowater 1998).

Suspended sediment load monitoring should begin prior to construction and continue until water quality returns to control conditions and there is no potential for additional sediment plumes. Sampling immediately downstream of the crossing (typically <100 m, the initial dilution zone) is important to document maximum sediment loads in the area with the highest potential for adverse effects. Depending on stream width, one or more samples should be taken at regular intervals across the watercourse. Surface samples are adequate in shallow watercourses (<0.5 m). Depth-integrated samples or samples taken from more than one depth may be required in deeper waters.

The first downstream site or transect should be regularly monitored prior to, during and immediately following, instream activities that have the potential to generate substantial sediment. Hourly sampling is appropriate immediately below the crossing, however, the frequency can be reduced depending on the length of time of instream construction and when levels return to control conditions (*e.g.*, overnight). Sampling frequency may also be increased when instream activities are of short duration, or a specific sediment generating event is planned. It is recommended that a construction log be kept to allow suspended sediment load data to be compared to construction activities.

Additional samples will generally be required further downstream to monitor plume attenuation and determine the extent of the area affected by sediment release. Samples at these sites or transects may not warrant the same sampling intensity as the sampling sites immediately downstream of the crossing. However,

supplementary samples should be added to document the start, peak and passing of sediment plumes.

Sampling should occur upstream of the crossing to provide ‘control’ information on discharge and background levels of sediment load in the watercourse during construction. The upstream site should be located far enough upstream (typically >100 m) that it is not influenced by construction activity. Sampling frequency should be sufficient to detect natural variability in discharge and sediment load before, during and after construction.

Data logging technology is an option for monitoring that can provide more frequent turbidity measurements as well as around the clock monitoring. Data loggers should be strategically placed to best detect increases in turbidity. As discussed above, data loggers should be placed immediately downstream of the crossing site, further downstream and upstream. A combination of automatic sampling, manual sampling and observation is an effective turbidity monitoring technique.

7.1.3 Substrate Composition

Analysis of substrate composition downstream of the crossing site can also be used to document the deposition of sediments due to construction, monitor the physical recovery of habitats following disturbance and help calibrate sediment transport models. A variety of techniques are available, including grab sampling, freeze-core sampling, sediment traps, visual surveys and direct measures of streambed porosity (see for example Weaver and Fraley 1991; Mudroch and MacKnight 1994; Anderson *et al.* 1996). The selection of the most appropriate monitoring program will depend on the program objectives and logistic considerations such as access, season, equipment availability and budget. Qualified specialists should be involved in program design.

Grab and freeze-core samples remove a small amount of the streambed for size distribution analysis in the laboratory. When samples are taken prior to and following construction at one or more sites, changes in the relative abundance of small diameter sediment particles can be determined and sediment deposition rates can be quantified.

Sediment traps are used to directly monitor the accumulation of small diameter sediment particles. Clean washed aggregates are used to fill a cylinder that is buried flush with the surface of the streambed. Traps are installed prior to construction activities along transects located both above and below the crossing. The traps can be removed immediately after construction to assess deposition rates relative to the upstream controls, or be left in place to document sediment deposition and flushing over time.

In some watercourses, changes in channel and bottom profiles can be mapped at specified intervals along established transects. This method can be used to

document changes in substrate composition following construction, identify areas of sediment accumulation and monitor recovery.

Standard visual survey or substrate description techniques can be used to compare substrate conditions prior to and after construction. The advantage of visual surveys is that they can be conducted quickly and relatively cheaply. However, they do not provide direct measures of sediment deposition and are affected by surveyor training and experience.

7.1.4 Biological Monitoring

In order to directly measure effects on aquatic communities, aquatic invertebrate, fish, algae and riparian communities can be monitored to detect reductions in biodiversity, abundance, or sensitive species and life stages. Due to the wide variety of habitats and techniques available, qualified specialists should be involved to design a practical and cost-effective biological program. The following discussion outlines some factors that should be considered (see for example Tsui and McCart 1981; Weaver and Fraley 1991; Davis and Simon 1995; Hauer and Lamberti 1996).

Aquatic invertebrates (which mainly consist of aquatic insects, mites, molluscs, crustaceans and worms) are the group of freshwater organisms often used in aquatic biological monitoring (Resh *et al.* 1996). Aquatic invertebrates often live on the substrate, are sensitive to sediment deposition, are easy to monitor, are relatively immobile and are an important food source for fish and other riparian animals. Aquatic invertebrate monitoring can be used to document changes in substrate composition following construction, identify areas of sediment accumulation and track recovery.

Ideally, aquatic invertebrate sampling sites should be located above and below the crossing in riffle habitats, where communities characteristic of streams and rivers are best represented, fauna diversity is highest and sensitive taxa are most likely to occur. Precise sampling locations should be selected to reflect the sediment plume mixing pattern and ensure they have similar bottom substrate, depth, velocity, stream width, bank cover, etc. This sampling site selection process will help to reduce natural sources of variability in the benthic samples and improve their effectiveness for assessing actual effects of pipeline construction. Benthic invertebrate monitoring data from control sites located upstream of the crossing will allow background natural variability in benthic invertebrate communities to be described.

Fish communities are sensitive, economically and socially important, and respond to changes in habitat, water quality and human exploitation. Both community composition and the presence of sensitive species and life stages have been used to identify the responses of fish communities to disturbance. Since fish are relatively mobile and the effects of short-term sediment input are most likely to be sublethal, most surveys of fish communities are conducted prior to and following

construction to evaluate the effects on distribution, abundance, growth and species composition. Sampling may also be continued over time to evaluate subsequent recovery.

Algae that live on the bottom of waterbodies (periphyton) are at the base of the aquatic food chain and can be affected both directly and indirectly by suspended and deposited sediment. Periphyton have been used to evaluate effects on water quality because they have short life cycles, reproduce rapidly and, therefore, respond quickly to changes in water quality. Sampling design considerations are similar to those for benthic invertebrates, but fewer experienced specialists are available to analyze samples.

Monitoring of riparian habitat and biota may also be appropriate where riparian areas are identified as sensitive or unusual. A discussion of terrestrial monitoring techniques is beyond the scope of this document and qualified technical specialists should be consulted to help design a riparian monitoring program.

In some cases, use of more than one biological group or sampling technique may be required to fulfill legal requirements, evaluate effects on aquatic and riparian communities, or test predictions.

7.1.5 Additional Monitoring for Horizontal Directional Drills

Where feasible, the onshore and instream portions of the drill path and zone-of-influence should be visually monitored for signs of drilling mud release. The size of the area to be monitored should be determined by evaluating geotechnical conditions (*i.e.*, amount of fracturing, type and depth of substrate) and drilling conditions (*i.e.*, depth of drill path, distance between the watercourse and entry and exit points). Monitoring should be on a continuous basis during drilling operations and continue for at least eight hours, where feasible, after shut-down. Personnel equipped with walkie-talkies should be positioned at the most advantageous locations to observe any sign of a release of drilling mud to the surface or in the watercourse. Contact must be maintained at all times between monitoring and drilling personnel.

The amount of fluid return to the mud tank/pit and the amount of make up drilling fluid required in the mixing tanks should be monitored during drilling of the pilot hole and opening (reaming). If a frac-out occurs, there will be a decrease in the fluid return to the mud tank/pit because fluid has exited the drilling path. A detailed log of all drilling activities should be maintained in order to correlate drilling status with potential frac-out events.

Annular pressures can also be monitored and recorded. Annular pressure is the fluid pressure in the space (*i.e.* annulus) between the borehole and drill pipe. A decrease in annular pressure may be indicative of a frac-out.

A more detailed description of construction and monitoring for HDD is provided in *Planning Horizontal Directional Drilling for Pipeline Construction* (CAPP 2004).

7.1.6 Monitoring During Blasting and Diversions

Specific monitoring requirements are generally specified in authorizations issued under Section 32 and/or Subsection 35(2) of the *Fisheries Act*. These typically include requirements to monitor fish distribution in the vicinity of the crossing prior to, during and following blasting and stream diversion activities as well as requirements to undertake and document fish salvage programs. Further measures may include monitoring to assess compliance and evaluation of the effectiveness of fish habitat mitigation and/or compensation program.

Geophone or hydrophone monitoring may also be used to document pressure and impulse velocities during blasting.

7.2 Post-Construction Monitoring

A post-construction monitoring program should be based on specified watercourse crossing objectives and terms of authorizations, permits, licences or compensation agreements. Post-construction monitoring may be undertaken to:

- confirm that specific crossing objectives have been achieved;
- confirm the effectiveness of protection and compensation techniques;
- observe actual effects;
- observe recovery;
- determine the need for maintenance of structures and mitigative measures; and
- fulfill explicit mitigation and compensation requirements.

Typical post-construction habitat and biological monitoring programs last for at least one year and involve periodic monitoring of habitat, aquatic invertebrates, water quality, or fish species and life stage presence and numbers. Typically, measurements of predefined habitat parameters are combined with biological sampling at transects above and below the crossing. Methods similar to those described above for construction monitoring are used in conjunction with upstream or nearby control areas so that the influence of natural ambient factors can be identified.

Post-construction monitoring should also include periodic inspection of erosion control and habitat restoration/enhancement structures so that necessary maintenance or replacement can be undertaken (Adams and Whyte 1990).

8 References

- Adams, M.A. and I.W. Whyte. 1990. Fish Habitat Enhancement: A Manual for Freshwater, Estuarine and Marine Habitats. Department of Fisheries and Oceans Canada. DFO 4474. 330 pp.
- Alaska Department of Fish and Game. 1997. Kenai River Habitat Protection and Streambank Restoration Project. Habitat and Restoration Division.
- Alberta Energy and Natural Resources. 1985. Stream Crossing Guidelines: Operational Guidelines for Industry.
- Alberta Environment. 1988. Environmental Handbook for Pipeline Construction. Regulated Operations Branch, Land Reclamation Division, Edmonton. 90pp.
- Alberta Environment. 1990. Design Guidelines Application Procedures for a Bridge, Culvert or Other Structure Crossing a Watercourse or Waterbody.
- Alberta Environment. 2000a. Code of Practice for Pipelines and Telecommunication Lines Crossing a Water Body. Includes Amendments to February 2007. 26 pp. Government of Alberta.
- Alberta Environment. 2000b. Code of Practice for Watercourse Crossings. Includes Amendments to February 2007. 26 pp. Government of Alberta.
- Alberta Environment. 2000c. Guide to the Code of Practice for Pipelines and Telecommunication Lines Crossing a Water Body, Including Guidelines for Complying with the Code of Practice. 29pp. Government of Alberta.
- Alberta Environment. 2000d. Guide to the Code of Practice for Watercourse Crossings, Including Guidelines for Complying with the Code of Practice. 29pp. Government of Alberta.
- Alberta Environmental Protection. 1994a. Design Guidelines and Application Procedures for Buried Pipeline(s) Crossing a Watercourse or Waterbody. Water Resources Administration Division.
- Alberta Environmental Protection. 1994b. Environmental Protection Guidelines for Pipelines. Conservation and Reclamation Information Letter 94-5.
- Alberta Environmental Protection. 1994c. Guide for Pipelines Pursuant to the Environmental Protection and Enhancement *Act* and Regulations. Land Reclamation Division.
- Alberta Environmental Protection. 1997a. Conservation and Reclamation Guidelines for Alberta. Conservation and Reclamation Information Letter 97-1.

- Alberta Environmental Protection. 1997b. Guidelines for Application of Fish and Wildlife Conditions to Land Use Activities in North East Slopes Region (DRAFT).
- Alberta Forestry, Lands and Wildlife. 1987a. Fisheries Habitat Protection Guidelines #3 - Pipeline Construction and Stream Crossing.
- Alberta Forestry, Lands and Wildlife. 1987b. Fisheries Habitat Protection Guidelines #7 - Timber Harvesting and Fish Habitat.
- Alberta Forestry, Lands and Wildlife. 1987c. Fisheries Habitat Protection Guidelines #15 - Use of Explosives in Water.
- Alberta Forestry, Lands and Wildlife. 1992a. Fisheries Habitat Protection Guidelines #4 - Vehicular Access Across Watercourses.
- Alberta Forestry, Lands and Wildlife. 1992b. Fisheries Habitat Protection Guidelines #6 - Timing Constraints on Construction In and Around Watercourses.
- Alberta Forestry, Lands and Wildlife. 1993. Fisheries Habitat Protection Guidelines #10 - Water Intakes: Screen Requirements for Fisheries.
- Alberta Transportation. 2001. Fish Habitat Manual: Guidelines and Procedures for Watercourse Crossings in Alberta. Revised August 2009. Government of Alberta.
- Alliance Pipeline Limited Partnership. 1997. Application to the National Energy Board for a Certification of Public Convenience and Necessity. Environmental Plans - Volume V.
- Alliance Pipeline Limited Partnership. 1998. Application to the National Energy Board for a Certification of Public Convenience and Necessity. Environmental Plans - Volume V (Revision 2).
- American Society of Civil Engineers. 1996. Pipeline Crossings. ASCE Manuals and Reports on Engineering Practice No. 89. Prepared by the Task Committee on Pipeline Crossings of the Technical Committee on Pipeline Crossings of the Pipeline Division of the American Society of Civil Engineers.
- Anderson, P.G., B.R. Taylor and G.C. Balch. 1996. Quantifying the Effects of Sediment Release on Fish and their Habitats. Prepared for the Eastern B.C. Habitat Unit and Alberta Area Habitat Management Division, Department of Fisheries and Oceans. Canadian Manuscript Report of Fisheries and Aquatic Sciences No. 2346. 110 pp. + appendices.

- Anderson, P.G., C.G.J. Fraikin and T.J. Chandler. 1997. Impacts and Recovery in a Coldwater Stream Following Natural Gas Pipeline Crossing Installation. Pages 1013-1022 in: Proceedings of the 6th International Symposium, Environmental Concerns in Right-of-way Management, held February 22-26, 1997, New Orleans, Louisiana.
- Angermeier, P.L., A.P. Wheeler, and A.E. Rosenberger. 2004. A conceptual framework for assessing impacts of roads on aquatic biota. *Fisheries*. 29(12):19-29.
- British Columbia Ministry of Environment. 2009. Environmental Assessment Office User Guide. Environmental Assessment Office, Victoria, British Columbia. 40pp.
- British Columbia Ministry of Forests, Lands and Natural Resource Operations, British Columbia Ministry of Environment, and Fisheries and Oceans Canada. 2012. Fish-stream Crossing Guidebook. Revised Edition. Province of British Columbia. Victoria, BC. 81 pp.
- British Columbia Ministry of Forests. 1995. Riparian Management Area Guidebook. Forest Practices Code of British Columbia guidebook. Forest Practices Codes. Forest Practices Branch, British Columbia Ministry of Forests, Victoria, British Columbia.
- British Columbia Ministry of Forests. 1998. Fish-Stream Identification Guidebook. Forest Practices Code of British Columbia guidebook. Forest Practices Codes. Forest Practices Branch, British Columbia Ministry of Forests, Victoria, British Columbia.
- British Columbia Ministry of Forests. 1999. Coastal Watershed Assessment Procedure Guidebook (CWAP) Interior Watershed Assessment Procedure Guidebook (IWAP), Second Edition, Version 2.1. Forest Practices Code of British Columbia guidebook. Forest Practices Codes. Forest Practices Branch, British Columbia Ministry of Forests, Victoria, British Columbia.
- British Columbia Ministry of Forests. 2002a. Fish-Stream Crossing Guidebook. Forest Practices Code of British Columbia guidebook. Forest Practices Codes. Forest Practices Branch, British Columbia Ministry of Forests, Victoria, British Columbia.
- British Columbia Ministry of Forests. 2002b. Forest Road Engineering Guidebook. Forest Practices Code of British Columbia guidebook. Forest Practices Codes. Forest Practices Branch, British Columbia Ministry of Forests, Victoria, British Columbia.

- British Columbia Ministry of Water, Land and Air Protection. 2004. Standards and Best Practices for Instream Works. 2004. British Columbia Ministry of Water, Land and Air Protection. Ecosystem Standards and Planning Biodiversity Branch. Government of British Columbia.
- British Columbia Oil and Gas Commission. 2004a. Stream Crossing Planning Guide (Northeast B.C.), Version 2.0 – December 15, 2004. Oil and Gas Commission. Fort St. John, British Columbia.
- British Columbia Oil and Gas Commission. 2004b. Fish Stream Identification Risk Management Tool. Oil and Gas Commission. Fort St. John, British Columbia.
- British Columbia Oil and Gas Commission. 2004c. Fish and Wildlife Timing Windows Document and Table. Oil and Gas Commission. Fort St. John, British Columbia.
- British Columbia Oil and Gas Commission. 2011. Environmental Protection and Management Guide Version 1.5. Oil and Gas Commission. Fort St. John, British Columbia.
- Canada Gazette. 2009. Minor Works and Waters (Navigable Waters Protection Act) Ministerial Order. Part 1 of the May 9, 2009 Canada Gazette. Ottawa, Ontario.
- Canadian Association of Petroleum Producers, Canadian Energy Pipeline Association and Canadian Gas Association. 2005. Pipeline Associated Watercourse Crossings, Third Edition. Prepared by TERA Environmental Consultants and Salmo Consulting Inc., Calgary Alberta.
- Canadian Association of Petroleum Producers. 1993. Watercourse Crossing Guidelines for Pipeline Systems.
- Canadian Association of Petroleum Producers. 1996. Hydrostatic Test Water Management. CAPP Publication No. 19960014.
- Canadian Association of Petroleum Producers. 2004. Planning Horizontal Directional Drilling for Pipeline Construction. CAPP Publication No. 2004-0022.
- Canadian Council of Ministers of the Environment. 2007. Canadian Water Quality Guidelines for the Protection of Aquatic Life: Summary Table. Updated December, 2007. In: Canadian Environmental Quality Guidelines, 1999, Canadian Council of Ministers of the Environment, Winnipeg, Manitoba.

- Canadian Environmental Assessment Agency. 1994. Responsible Authorities Guide. November 1994. Canadian Environmental Assessment Agency. Ottawa, Ontario.
- Canadian Environmental Assessment Agency. 2007. Addressing Cumulative Environmental Effects under the Canadian Environmental Assessment Act. Canadian Environmental Assessment Agency , Ottawa, Ontario.
- Canadian Petroleum Association. 1992. Environmental Operating Guidelines for the Saskatchewan Petroleum Industry. Prepared by David Bromley Engineering (1983) Ltd.
- Clowater, D. 1998. Standardization of Watercourse Sampling Protocols. Unpublished manuscript report prepared for Department of Civil Engineering, University of New Brunswick and Maritimes & Northeast Pipeline, New Brunswick. 29 pp.
- Davis, W.S. and T.P. Simon (eds.). 1995. Biological Assessment and Criteria: Tools for Water Resource Planning. Lewis Publishers, Boca Raton, Florida. 415 pp.
- Envirowest Environmental Consultants. 1990. Fish Habitat Enhancement: A Manual for Freshwater, Estuarine and Marine Habitats. Prepared for Department of Fisheries and Oceans, Vancouver, British Columbia, by Envirowest Environmental Consultants. 324 pp.
- Express Pipeline. 1995. Express Pipeline Project. Figure 3-1. Typical Sauerman Excavation. In: Report of the Joint Review Panel May 1996. National Energy Board and Canadian Environmental Assessment Agency.
- Fisheries and Oceans Canada and British Columbia Ministry of Environment. 1992. Land Use Guidelines for the Protection of Aquatic Habitat. Fisheries and Oceans Canada Habitat Management Branch and British Columbia Ministry of Environment Integrated Management Branch.
- Fisheries and Oceans Canada and Manitoba Department of Natural Resources. 1996. Manitoba Stream Crossing Guidelines for the Protection of Fish and Fish Habitat. Prepared by Marr Consulting and Communications Limited.
- Fisheries and Oceans Canada and Saskatchewan Environment and Resource Management. 1995. Fish Habitat Protection Guidelines: Road Construction and Stream Crossings. Fisheries Branch. 28pp.
- Fisheries and Oceans Canada. 1986. The Department of Fisheries and Oceans Policy for the Management of Fish Habitat. Fish Habitat Management Branch, Ottawa, Ontario. 28 pp.

- Fisheries and Oceans Canada. 1995a. Fish Habitat Conservation and Protection: Guidelines for Attaining No Net Loss.
- Fisheries and Oceans Canada. 1995b. Fish Habitat Conservation and Protection: What the Law Requires - The Directive on the Issuance of Subsection 35(2) Authorizations. 6pp.
- Fisheries and Oceans Canada. 1995c. Freshwater Intake End-of-Pipe Fish Screen Guideline. Fisheries and Oceans Canada, Ottawa, Ontario. 27pp.
- Fisheries and Oceans Canada. 1998. Decision Framework for the Determination and Authorization of Harmful Alteration, Disruption or Destruction of Fish Habitat. Habitat Management and Environmental Science. Habitat Management Branch. Fisheries and Oceans Canada, Ottawa, Ontario. 22pp.
- Fisheries and Oceans Canada. 1999. Habitat Conservation and Protection Guidelines - Second Edition - Developed from the Policy for the Management of Fish Habitat (1986).
- Fisheries and Oceans Canada. 2005. Practitioners Guide to the Risk Management Framework for DFO Habitat Management Staff. Version 1.0. Habitat Management Program Fisheries and Oceans Canada.
- Fisheries and Oceans Canada. 2006. Practitioners Guide to Habitat Compensation. Version 1.1. Fisheries and Oceans Canada. Version 1.1. Habitat Management Program Fisheries and Oceans Canada. 20pp.
- Fisheries and Oceans Canada. 2006. Practitioners Guide to Letters of Credit for DFO Habitat Management Staff. Fisheries and Oceans Canada. Version 1.0.
- Fisheries and Oceans Canada. 2007a. Habitat Compliance Decision Framework, Fisheries and Oceans Canada. Version 1.1. Habitat Management Program Fisheries and Oceans Canada. iii + 16pp.
- Fisheries and Oceans Canada. 2007b. Application of the Habitat Protection Provisions of the Fisheries Act to Existing Facilities and Structures. Fisheries and Oceans Communication Branch, Ottawa, Ontario. 4pp.
- Fisheries and Oceans Canada. 2007c. Practitioners Guide to Writing Letters Used in Fisheries Act and Species at Risk Act Reviews for Habitat Management Staff. Habitat Management Program. Version 2.0.
- Fisheries and Oceans Canada. 2007d. Practitioners Guide to Fish Passage for DFO Habitat Management Staff. Fisheries and Oceans Canada. Version 1.1.

- Fisheries and Oceans Canada. 2009a. Position Statement on the Management of Fish Mortality. Fisheries and Oceans Canada. Ottawa, Ontario.
- Fisheries and Oceans Canada. 2009b. Proponent's Guide to Information Requirements for Review Under the Fish Habitat Protection Provisions of the Fisheries Act. Version 1.2. Habitat Management Program Fisheries and Oceans Canada. 8pp.
- Fisheries and Oceans Canada. 2010. Information Requirements to include in your Compensation Plan from the Additional Information for a Fisheries Act Authorization Review Process while Working Near Water. Fisheries and Oceans Canada Pacific Region Website: <http://www.pac.dfo-mpo.gc.ca/habitat/steps/authorization/additional-auth-eng.htm>.
- Fisheries and Oceans Canada. 2012. Practitioners Guide to Writing an Authorization for the Habitat Protection Provisions of the Fisheries Act. Fisheries and Oceans Canada. Version 2.0. Habitat Management Program Fisheries and Oceans Canada. 20pp.
- Ford, B.S., P.S. Higgins, A.F. Lewis, K.L. Cooper, T.A. Watson, C.M. Gee, G.L. Ennis, and R.L. Sweeting. 1995. Literature reviews of the life history, habitat requirements and mitigation/compensation strategies for thirteen sport fish species in the Peace, Liard and Columbia river drainages of British Columbia. Vancouver, B.C. Department of Fisheries and Oceans Habitat and Enhancement Branch. Canadian Manuscript Report of Fisheries and Aquatic Sciences 2321. xxiv + 342 pp.
- Goodchild, G.A. and S. Metikosh. 1994. Fisheries-Related Information Requirements for Pipeline Water Crossings. Canadian Manuscript Report of Fisheries and Aquatic Sciences 2235. Fisheries and Habitat Management Branch, Central and Arctic Region, Fisheries and Oceans Canada.
- Government of Canada. 1995. National Energy Board Rules of Practice and Procedure. SOR/95-208. Available online: <http://www.canlii.org/ca/regu/sor95-208/>
- Government of Canada. 2009. Draft Rules of Practice and Procedure, 20XX National Energy Board Act Draft for information only 31 August 2009 includes amendments since 1995. 45pp.
- Greater Golden Horseshoe Area Conservation Authorities. 2006. Erosion and Sediment Control Guidelines for Urban Construction. Harder, P.A. and Associates Ltd. 1996. Case History Review of Directional Drill Projects for Water Crossings. Prepared for Westcoast Energy Inc.
- Hauer, F. R. and G.A. Lamberti (eds.). Methods in Stream Ecology. Academic Press. 674 pp.

- Hegmann, G., C. Cocklin, R. Creasey, S. Dupuis, A. Kennedy, L. Kingsley, W. Ross, H. Spaling, and D. Stalker. 1999. Cumulative effects assessment practitioners guide. Prepared by Axys Environmental Consulting Ltd. and the CEA Working Group for the Canadian Environmental Assessment Agency, Hull, Quebec.
- MacDonald, G. and C. Bjornson. 1993. Suspended Sediment Monitoring for Pipeline Crossings of the Sukunka River and Rocky Creek. Prepared for Talisman Energy Inc. by Golder Associates Ltd., Calgary, Alberta. 56 pp. + appendices.
- Meehan, W.R. (Ed.). 1991. Influences of forest and rangeland management on salmonid fishes and their habitats. American Fisheries Society, Bethesda, Maryland. AFS Special Publication No. 19. 751 pp.
- Minns, C.K. 1995. Calculating net change of productivity of fish habitats. Burlington, ON. Department of Fisheries and Oceans. Canadian Manuscript Report of Fisheries and Aquatic Sciences 2282. vi+37 pp.
- Minns, C.K. 1997. Quantifying 'no net loss' of productivity of fish habitats. Canadian Journal of Fisheries and Aquatic Sciences 54:2463-2473.
- Minns, C.K., J.D. Meisner, J.E. Moore, L.A. Greig, and R.G. Randall. 1995. Defensible methods for a pre- and post-development assessment of fish habitat in the Great Lakes. I. A prototype methodology for headlands and offshore structures. Burlington, ON. Department of Fisheries and Oceans. Canadian Manuscript Report of Fisheries and Aquatic Sciences 2328. xiii + 65 pp.
- Minns, C.K., J.R.M. Kelso, and R.G. Randall. 1996. Detecting the response of fish to habitat alterations in freshwater ecosystems. Canadian Journal of Fisheries and Aquatic Sciences. 53(Suppl.1)(1):403-414.
- Mudroch, A. and S.D. MacKnight (eds.). 1994. Handbook of Techniques for Aquatic Sediments Sampling, Second Edition. Lewis Publishers, Boca Raton, Florida. 236 pp.
- Mutrie, D.F. and I.F.H. Scott. 1984. Environmental Evaluation of Water Crossing Techniques for Pipeline Construction in Canada. In: Third International Symposium on Environmental Concerns in Rights of Way Management. February 15-18. 1982. San Diego, CA. Mississippi State University Press. 1984.
- National Energy Board. 2004. Filing Manual. Inclusive of Release 2012-2 (October 2012). Calgary, Alberta. National Energy Board, Calgary, Alberta. 260pp.

- Newcombe, C.P. and D.D. MacDonald. 1991. Effects of Suspended Sediments on Aquatic Ecosystems. *North American Journal of Fisheries Management*. 11:72-82.
- Ontario Energy Board. 2011. Environmental Guidelines for Locating, Constructing and Operating Hydrocarbon Pipelines in Ontario. Sixth Edition. 62 pp.
- Ontario Ministry of Environment and Energy. 1995. Guidelines for Evaluating Construction Activities Impacting on Water Resources. Program Development Branch.
- Ontario Ministry of Natural Resources. 1990. Environmental Guidelines for Access Roads and Water Crossings. 62 pp.
- Ontario Ministry of Natural Resources. 1993a. Ontario Generic Sediment Control Plans.
- Ontario Ministry of Natural Resources. 1993b. Sediment Control Plans for Wet Crossings.
- Ontario Ministry of Natural Resources. 2009. Fish Habitat Referral Protocol for Ontario. in conjunction with the Aquatic Resources Management Advisory Committee, Ontario Ministry of Natural Resources, Ontario Fisheries Advisory Board, Regulatory Management Working Group and Conservation Ontario. 64 pp.
- Ontario Ministry of the Environment. 1984. Water Management - Goals, Policies, Objectives and Implementation Procedures of the Ministry of the Environment. 70 pp.
- Pipeline Abandonment Steering Committee (PASC). 1996. Pipeline Abandonment: A Discussion Paper on Technical and Environmental Issues. Prepared for the Pipeline Abandonment Steering Committee (comprised of representatives from the Canadian Association of Petroleum Producers, the Canadian Energy Pipeline Association, the Alberta Energy and Utilities Board, and the National Energy Board). 36 pp.
- Portt, C.B., G. Coker and C.K. Minns. 1999. Riverine habitat characteristics of fishes of the Great Lakes watershed. Fisheries and Oceans Canada. Canadian Manuscript of Fisheries and Aquatic Sciences No. 2481. vi+62 pp.
- Prince Edward Island Watercourse Alterations Advisory Committee. 1989. Includes Amendments to 2006. Watercourse Alteration: Guidelines for the Protection of Fish and Wildlife Habitats in Prince Edward Island. 56 pp.

- Province of New Brunswick Department of Environment. 2012. Watercourse Alterations Technical Guidelines. Province of New Brunswick Department of Environment. 119pp.
- Quigley, J.T. and D.J. Harper. 2005a. No Net Loss of Fish Habitat: A Review and Analysis of Habitat Compensation in Canada. *Environmental Management* 36(3): 343–355
- Quigley, J.T. and D.J. Harper. 2005b. A Comparison of the Areal Extent of Fish Habitat Gains and Losses Associated with Selected Compensation Projects in Canada. *Fisheries* 30(2): 18-25.
- Resh, V.H., M.J. Myers and M.J. Hannaford. 1996. Macroinvertebrates as Biotic Indicators of Environmental Quality. Chapter 31 in: F. R. Hauer and G.A. Lamberti (eds.). *Methods in Stream Ecology*. Academic Press. p. 647-667.
- Resources Inventory Committee. 1997. Fish Collection Methods and Standards Version 4. Prepared by the British Columbia Ministry of Environment, Lands and Parks, Fish Inventory Unit for the Aquatic Ecosystems Task Force, Resources Inventory Committee. 39pp.
- Resources Inventory Committee. 1999. Reconnaissance (1:20,000) Fish and Fish Habitat Inventory Site Card Field Guide. Authority: Reconnaissance (1:20,000) Fish and Fish Habitat Inventory: Standards and Procedures, version 1.1, RIC (1998); Errata (March 1999). 41pp.
- Resources Inventory Committee. 2001. Reconnaissance (1:20,000) Fish and Fish Habitat Inventory: Standards and Procedures, Version 2.0. Prepared by Information Services Branch, British Columbia. Fisheries for the Resources Inventory Committee. 170pp.
- Saskatchewan Environment. 2000. Guidelines for Preparation of an Environmental Protection Plan (EPP) for Oil and Gas Projects Procedures under the *Environmental Assessment Act* (Saskatchewan) Environmental Assessment Branch Saskatchewan Environment and Resource Management. 9pp..
- Schiechtl, H. 1980. Bioengineering for Land Reclamation and Conservation. University of Alberta Press 1980. Translated by N.K. Horstman. 404 p.
- Scott, W.B. and E.J. Crossman. 1973. Freshwater Fishes of Canada. Bulletin 184. Fisheries Research Board of Canada. Ottawa, Ontario. 966 pp.
- Shen, H.W. and P.Y. Julien. 1993. Erosion and Sediment Transport. Chapter 12. In D.R. Maidment (ed) *Handbook of Hydrology*. McGraw Hill Inc, New York. 12.1 - 12.61.

- TERA Environmental Consultants. 1996. Water Crossing Case History Review. Prepared for Westcoast Energy Inc.
- TransCanada PipeLines Limited. 1994. Water Crossing Manual.
- Transport Canada. 2009a. Pipeline Crossings. The Navigable Waters Protection Act Minor Works Policy. Transport Canada TP 14593 (12/2009) TC 1003246 (T29-8/2009). Ministry of Transport.
- Transport Canada. 2009b. Erosion Protection Works. The Navigable Waters Protection Act Minor Works Policy. Transport Canada TP 14594 (12/2009) TC 1003247 (T29-13/2009). Ministry of Transport.
- Transport Canada. 2009c. Dredging. The Navigable Waters Protection Act Minor Works Policy. Transport Canada TP 14597 (12/2009) TC 1003244 (T29-9/2009). Ministry of Transport.
- Transport Canada. 2009d. Winter Crossings. The Navigable Waters Protection Act Minor Works Policy. Transport Canada TP 145590 (12/2009) TC 1003253 (T29-12/2009). Ministry of Transport.
- Transport Canada. 2009e. Water Intakes. The Navigable Waters Protection Act Minor Works Policy. Transport Canada TP 14591 (12/2009) TC 1003250 (T29-15/2009). Ministry of Transport.
- Transport Canada. 2009f. Temporary Works. The Navigable Waters Protection Act Minor Works Policy. Transport Canada TP 14893 (12/2009) TC 1003186 (T29-57/2009). Ministry of Transport.
- Transport Canada. 2010a. Minor Waters Users Guide. Minor Works and Waters (Navigable Waters Protection Act) Order. TP 14838E (03/2010). TC 1002965 (T29-60/2009E – PDF). Ministry of Transport.
- Trow Consulting Engineers Ltd. 1996. Instream Sediment Control Techniques Field Implementation Manual. Ontario Ministry of Natural Resources Publication FG 007. October. 1997.
- Tsui, P.T.P. and P.J. McCart. 1981. Effects of Stream-Crossing by a Pipeline on the Benthic Macroinvertebrate Communities of a Small Mountain Stream. *Hydrobiologia*. 79:271-176.
- Warren, M.L., Jr. and M.G. Pardew. 1998. Road crossings as barriers to small-stream fish movement. *Transactions of the American Fisheries Society*. 127:637-644.

Weaver, T. and J. Fraley. 1991. Flathead Basin Forest Practices Water Quality and Fisheries Cooperative: Fisheries Habitat and Fish Populations. Prepared by the Montana Department of Fish, Wildlife and Parks for Flathead Basin Commission, Kalispell, Montana. 47 pp.

Wesche, T.A. 1985. Stream Channel Modifications and Reclamation Structures to Enhance Fish Habitat. p. 103-164 In: Gore, J. A. (ed.). 1985. The Restoration of Rivers and Streams: Theories and Experience. Butterworth Publishers, Toronto. 280 p.

Appendix A Typical Watercourse Crossing Drawings

LIST OF DRAWINGS

Dwg. No. 1	Construction Technique - Typical Plow
Dwg. No. 2	Construction Technique - Typical Open Cut of Small Watercourses
Dwg. No. 3	Construction Technique - Typical Open Cut of Large Watercourses
Dwg. No. 4	Construction Technique - Typical Dragline
Dwg. No. 5	Construction Technique - Typical Flume
Dwg. No. 6	Construction Technique - Typical Dam and Pump
Dwg. No. 7	Construction Technique - Typical High Volume Pump Bypass
Dwg. No. 8	Construction Technique - Typical Two Stage Cofferdams
Dwg. No. 9	Construction Technique - Typical Channel Diversion
Dwg. No. 10	Construction Technique - Typical Bore or Punch
Dwg. No. 11a&b	Construction Technique - Typical Horizontal Directional Drill
Dwg. No. 12	Vehicle Crossing - Typical Temporary Bridge
Dwg. No. 13	Vehicle Crossing - Typical Ice Bridge
Dwg. No. 14	Vehicle Crossing - Typical Ramp and Culvert
Dwg. No. 15	Vehicle Crossing - Typical Ford
Dwg. No. 16	Sediment Control - Typical Spoil Berms
Dwg. No. 17	Sediment Control - Typical Silt Fences
Dwg. No. 18	Sediment Control - Typical Straw Bales
Dwg. No. 19	Subsurface Drainage Control - Typical Trench Breakers
Dwg. No. 20	Subsurface Drainage Control - Typical Subdrain
Dwg. No. 21	Subsurface Drainage Control - Typical Pole Drains
Dwg. No. 22	Surface Erosion Control - Typical Cross Ditches and Diversion Berms
Dwg. No. 23	Streambank Protection - Rip Rap Armour
Dwg. No. 24	Streambank Protection - Typical Coniferous Tree Revetment
Dwg. No. 25	Streambank Protection - Typical Gabion Baskets
Dwg. No. 26	Streambank Protection - Typical Coir Logs
Dwg. No. 27	Streambank Protection - Typical Grass Roll
Dwg. No. 28	Streambank Protection - Typical Shrub Restoration
Dwg. No. 29	Streambank Protection - Typical Log and Crib Walls
Dwg. No. 30	Streambank Protection - Typical Hedge / Brush Layering
Dwg. No. 31	Instream Cover - Typical Rock Clusters
Dwg. No. 32	Instream Cover - Typical Log / Root Balls
Dwg. No. 33	Instream Cover - Typical Submerged Cover
Dwg. No. 34	Instream Cover - Typical Bank Overhang
Dwg. No. 35	Current Deflectors - Typical Opposing Rock Wing Deflectors
Dwg. No. 36	Current Deflectors - Typical Log Deflector (Small Watercourses, Width <5 m)
Dwg. No. 37	Current Deflectors - Typical Groynes - Full Size
Dwg. No. 38	Overpour Structures - Typical Log V Weir (Small Watercourses, Width <5 m)
Dwg. No. 39	Overpour Structures - Typical Log K Dam (Small Watercourses, Width <5 m)
Dwg. No. 40	Overpour Structures - Typical V Weir - Single Crest (Small Watercourses)
Dwg. No. 41	Overpour Structures - Typical V Weir - Double Crest (Large Watercourses)
Dwg. No. 42	Substrate Manipulation - Typical Resting Pool
Dwg. No. 43	Substrate Manipulation - Typical Excavated Fish Run

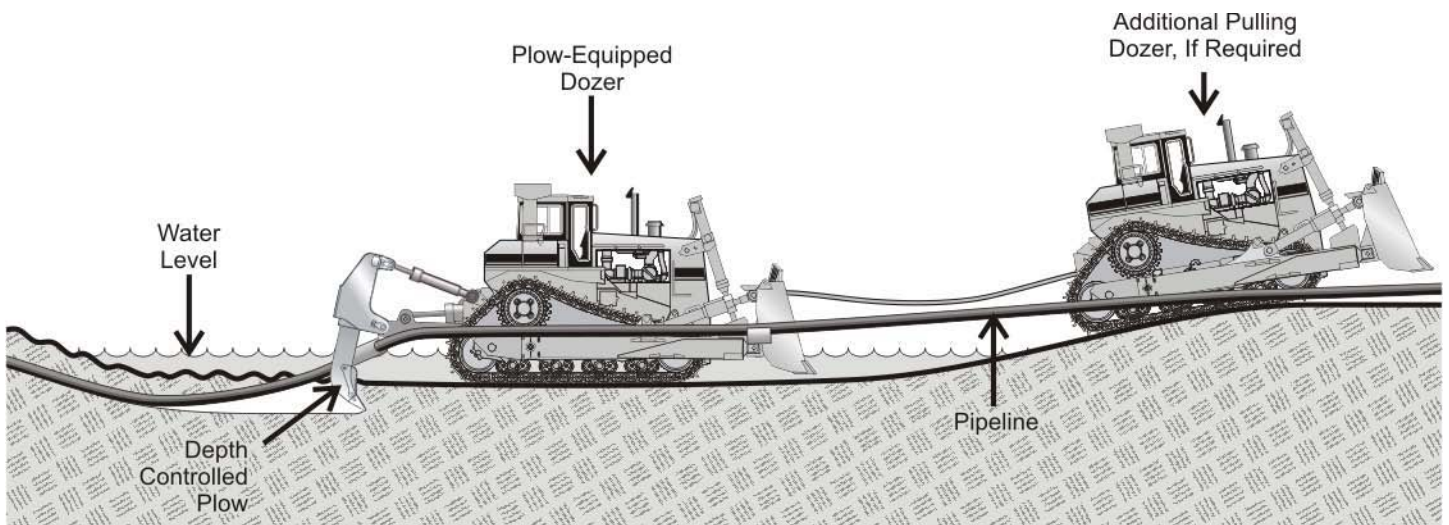

PROFILE
(Not to Scale)

Notes:

1. Maintain a vegetation buffer at the crossing to the extent practical.
2. Install sediment and erosion control structures, if warranted.
3. Grade banks to allow access to watercourse by plowing equipment.
4. Complete construction of the instream pipe section.
5. Assist plow dozer with an additional pulling dozer, if warranted. Ensure adequate pulling power is used to plow through watercourse substrate.
6. Regrade the banks. Restore, stabilize and reclaim watercourse banks and approaches to as close to the preconstruction profile as practical.

Adapted from CAPP *et al.* (2005)

CONSTRUCTION TECHNIQUE – TYPICAL PLOW



canadian
energy
pipeline
association

association
canadienne
de pipelines
d'énergie



Fourth Edition

November 2012

DWG. NO. 1

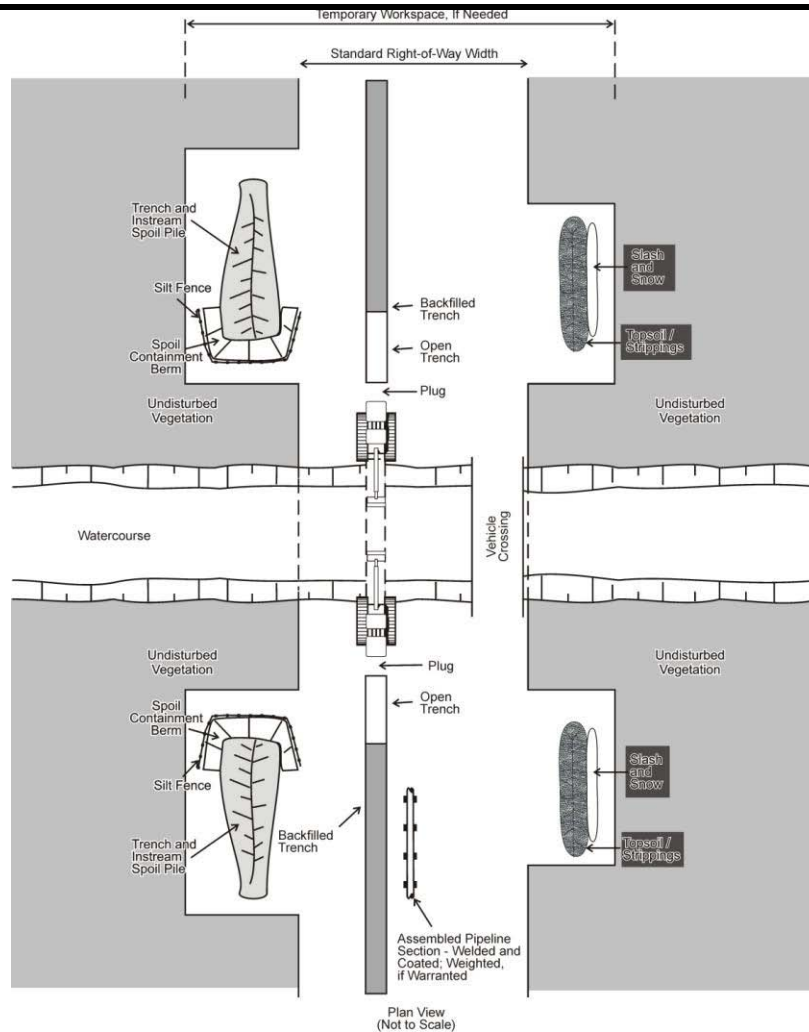

Notes:

1. Obtain additional temporary workspace to allow instream spoil to be stored on banks.
2. Install vehicle crossing if needed.
3. Install sediment and erosion control structures, if warranted.
4. Leave trench plugs at both ends of the standard trench.
5. Complete construction of the instream pipe section. Weight and pretest pipe, if warranted, prior to commencement of instream activity.
6. Trench through the watercourse retaining hard plugs back from each bank until just prior to pipe installation. Stockpile all instream spoil on the banks. Construct berms (e.g., subsoil, saddle weights, shotrock) to prevent saturated spoil from flowing back into the watercourse (see Dwg. 16). Maintain streamflow, if present, throughout crossing construction.
7. Lower-in and backfill immediately. Restore the stream channel to approximate preconstruction profile and substrate. Attempt to complete all instream activity within one working day.
8. If necessary to control water flow and trench sloughing, install temporary soft plugs and the dewater trench on to stable vegetated land, not directly to watercourse.
9. Restore, stabilize and reclaim the watercourse banks and approaches to as close to the preconstruction grade profile as practical.

Adapted from CAPP *et al.* (2005)

CONSTRUCTION TECHNIQUE – TYPICAL OPEN CUT OF SMALL WATERCOURSES



canadian energy pipeline association
association canadienne de pipelines d'énergie



Fourth Edition

November 2012

DWG. NO. 2

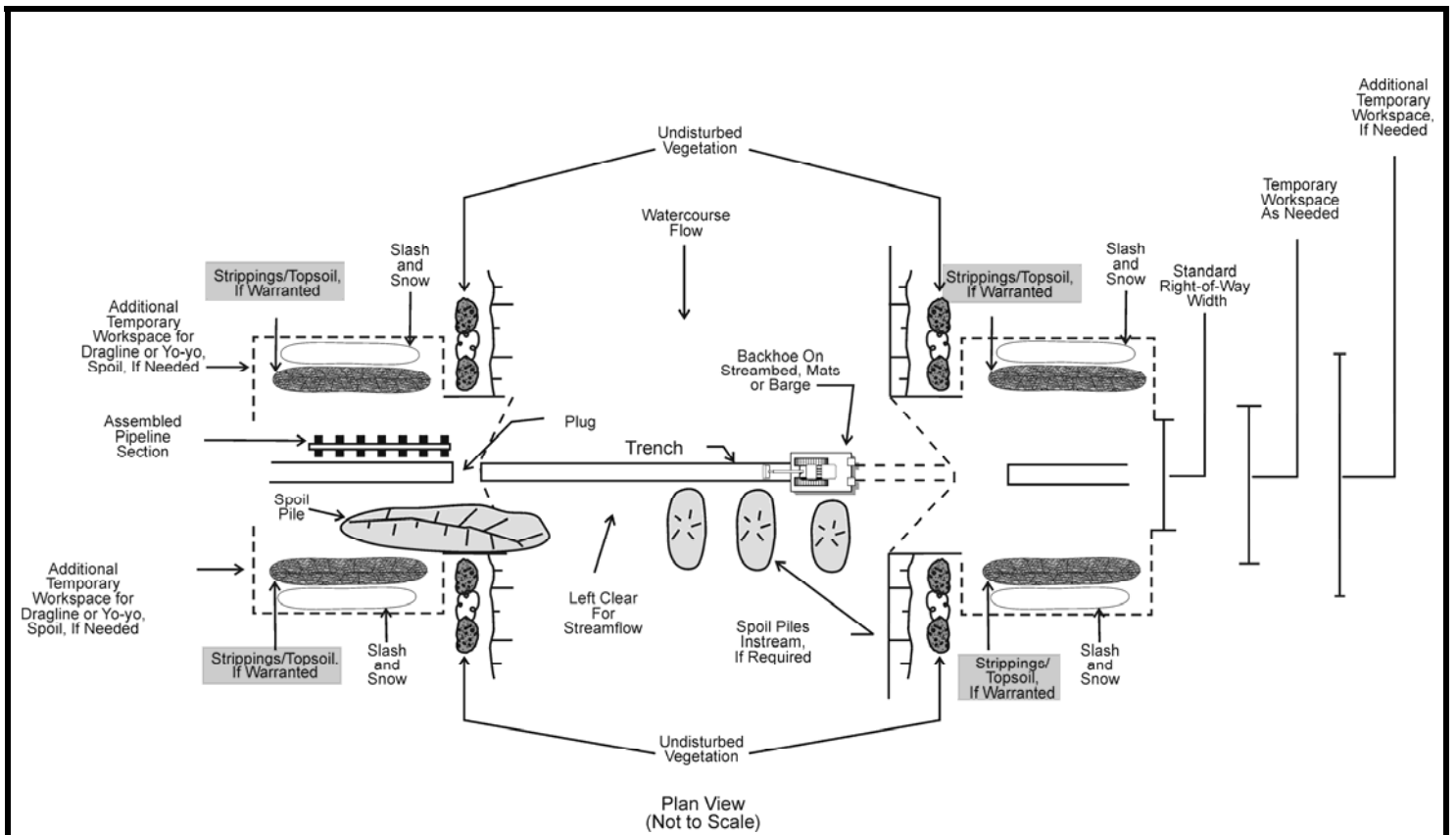

Notes:

1. Obtain additional temporary workspace to allow as much instream spoil to be stored on the banks as is practical.
2. Leave trench plugs at both ends of the standard trench.
3. Install sediment and erosion control structures, if warranted.
4. Complete construction of the instream pipe section. Weight and if warranted, pretest the pipe well in advance of anticipated completion of instream trenching.
5. Retain trench plugs back from each bank until just prior to pipe installation. Stockpile as much spoil on the banks as feasible. Place instream storage spoil in piles avoiding areas of highest water velocity. Instream spoil should be piled in long piles parallel to flow in order to reduce erosion. Do not windrow spoil across the channel or block more than 2/3 of the channel. Maintain streamflow, if present, throughout crossing construction. Exact trenching and spoil storage requirements will depend on local conditions and equipment used.
6. If necessary to control water flow and trench sloughing, install temporary soft plugs and dewater trench on to stable vegetated land, not directly to watercourse.
7. Lower-in pipe and backfill immediately. Restore the stream channel to approximate preconstruction profile and substrate. Attempt to complete all instream activity as quickly as practical.
8. Restore, stabilize and reclaim the watercourse banks and approaches to as close to the preconstruction profile as practical.

Adapted from CAPP *et al.* (2005)

CONSTRUCTION TECHNIQUE – TYPICAL OPEN CUT OF LARGE WATERCOURSES



canadian
energy
pipeline
association
canadienne
des pipelines
d'énergie



Fourth Edition

November 2012

DWG. NO. 3

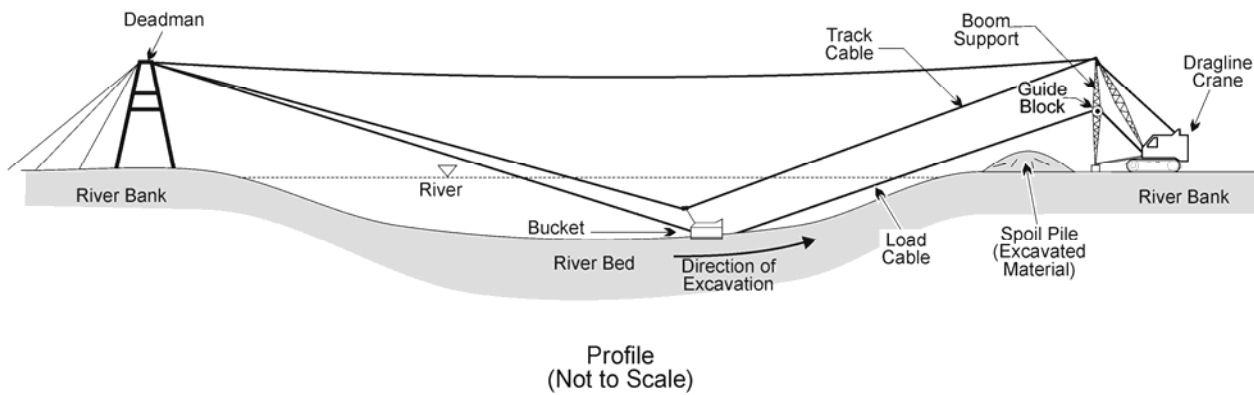
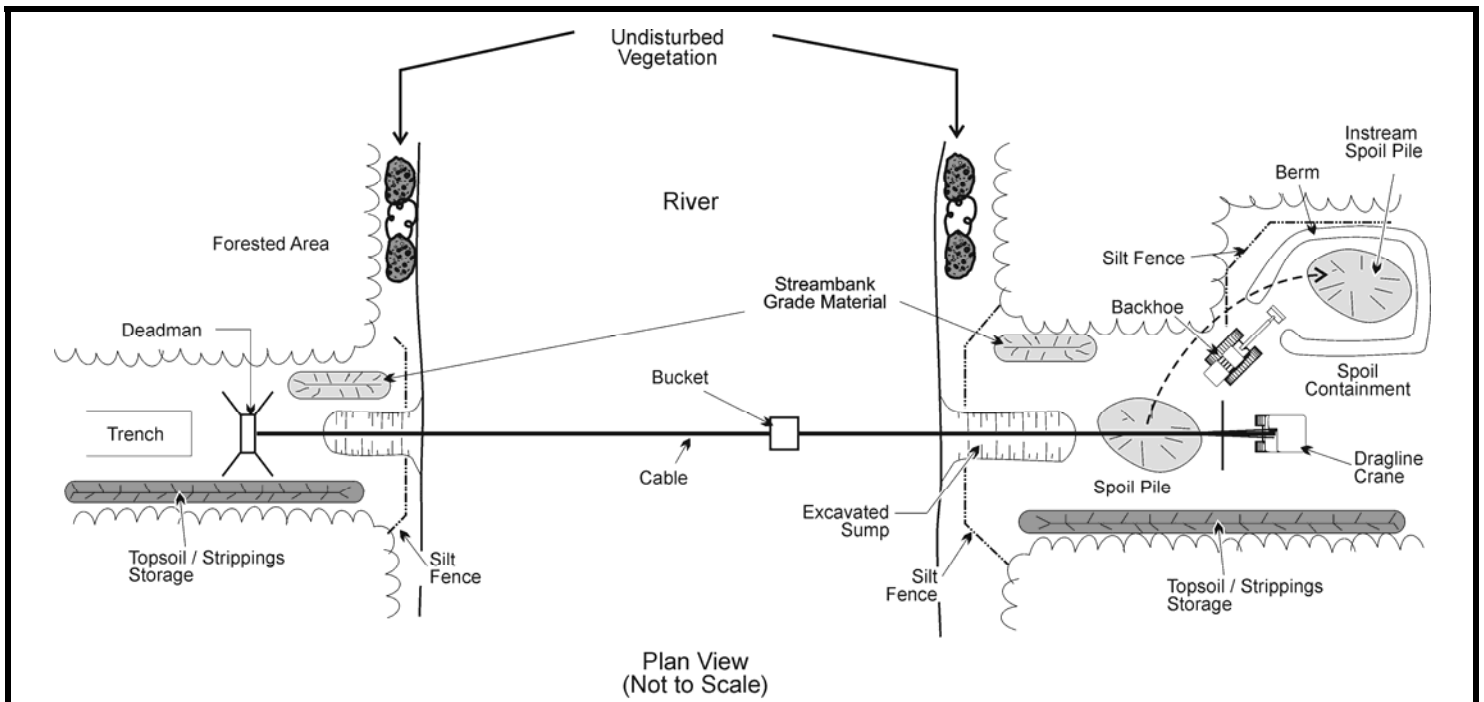

Notes:

1. Schedule instream activity for low flow periods and for the appropriate timing window, if feasible and unless otherwise approved by Fisheries authorities.
2. Obtain additional temporary work space to allow instream spoil to be stored on banks.
3. Complete construction of the instream pipe section. Weight and, if warranted, pretest the pipe, well in advance of anticipated completion of instream activity.
4. Construct berm and/or sump to prevent saturated spoil from flowing back into watercourse. Use earth moving equipment to move excavated spoil to a remote storage pile. Attempt to complete all instream activity as quickly as practical.
5. Restore the stream channel to approximate preconstruction profile and substrate. Restore, stabilize and reclaim watercourse banks and approaches to as close to the preconstruction profile as practical.

Adapted from Express Pipeline 1995, TCPL 1994

CONSTRUCTION TECHNIQUE – TYPICAL DRAGLINE



canadian
energy
pipeline
association

association
canadienne
de pipelines
d'énergie



Fourth Edition

November 2012

DWG. NO. 4

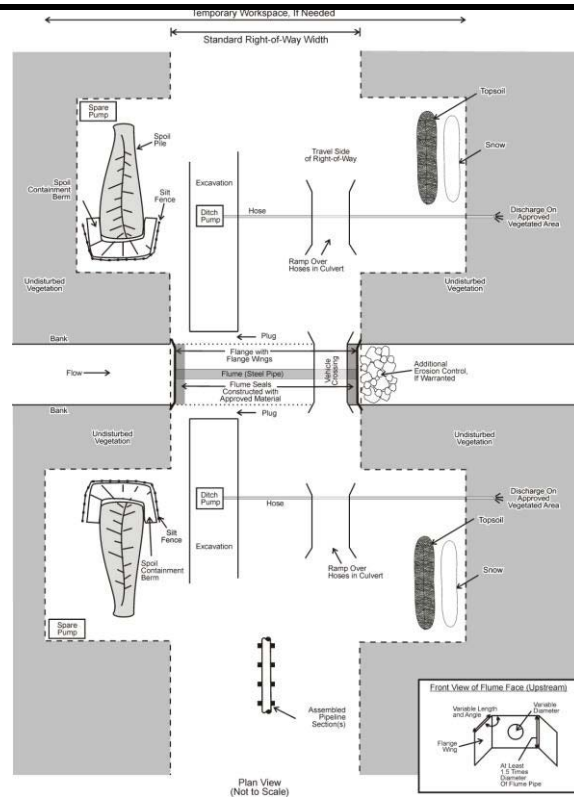

Notes:

1. Install the vehicle crossing, if needed, on the work side edge of the right-of-way to allow for a wide excavation.
2. Size the flume to handle anticipated flows.
3. Stockpile all required materials prior to beginning instream work. Complete construction of the instream pipe section. Weight and, if warranted, pretest pipe prior to commencing instream activity.
4. Install a pre-assembled flume, or construct a flume and install both an upstream and downstream dam.
5. Install additional erosion control, if warranted, downstream of the flume outlet.
6. Ensure a tight seal about the dam and flume prior to undertaking trench excavation. Beginning in the early morning, salvage the upper 0.5 m (minimum) of clean granular material, if present, and stockpile separately from the remainder of the trench spoil. Excavate the trench as quickly as practical placing spoil out of the stream channel. Create spoil containment sumps or berms, if warranted, to keep spoil from flowing back into the stream channel.
7. Pump the excavation, if necessary, to prevent downstream flow of silted water. Direct the pumped water onto vegetated areas well back from the watercourse. Construct water containment sumps, if warranted.

8. Immediately initiate fish salvage from isolated pools. Ensure fish salvage permit(s) are acquired prior to installing pump.
9. Install the pipe.
10. Backfill the stream channel first, squeezing the silted water into the bank excavations. Pump or drain the bank excavations while progressively backfilling from the stream channel outward.
11. Cap the upper 0.5 m (minimum) of the trench with salvaged clean granular material.
12. Complete backfill and stabilize the bed; leaving a small, shallow (<0.5 m) sump upstream of the downstream dam. Install a pump intake in this sump.
13. Slowly elevate a corner of flume (or edge of dam) and/or shut down auxiliary bypass pumps, and allow isolated channel to be flushed with water. Silt-laden water will flow into the shallow sump and then be pumped onto well-vegetated area.
14. Once the isolated channel is flushed, remove downstream seal materials.
15. Remove upstream seal materials.
16. Remove the flume.
17. Restore and stabilize the bed and banks of the stream channel to preconstruction profiles.

Adapted from CAPP *et al.* (2005)

CONSTRUCTION TECHNIQUE – TYPICAL FLUME



canadian energy pipeline association / association canadienne de pipelines d'énergie



Fourth Edition

November 2012

DWG. NO. 5

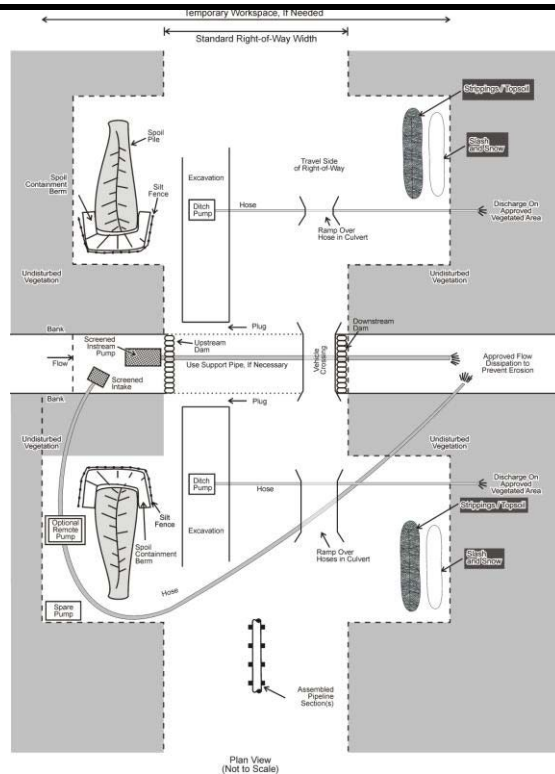

Notes:

1. Install the vehicle crossing if needed on the work side edge of the right-of-way to allow for a wide excavation.
2. Stockpile all necessary materials and equipment onsite prior to beginning instream work.
3. Complete construction of the instream pipe section. Weight, coat and if, warranted, pretest pipe prior to the commencement of instream activity.
4. Begin the operation in the early morning to allow for same day installation if practical.
5. Install pump in natural pool upstream of the excavation. Excavate temporary sump within right-of-way if no natural pool exists. Check pump and check operation to equalize flow. Screen pump intakes with screen openings no larger than 2.54 mm. Size the screen to ensure that water approach velocities do not result in entrainment or entrapment of fish.
6. Immediately initiate fish salvage from isolated pools. Ensure fish salvage permit(s) are acquired prior to installing pump.
7. Construct the upstream dam. The Dam should be constructed on the edge of the temporary workspace to allow for a wide excavation. Ensure the dam is impermeable by installing a polyethylene liner. The dam may be constructed with sand bags, aquadam, sheet piling or other approved material that ensures a tight seal of the bed and banks.
Assess the need to dewater isolated section of the watercourse and ensure tight seal about dams prior to trenching.
8. Plug the vehicle crossing culvert or construct the downstream dam. Where a bridge is used, the dam should be constructed as close to the edge of the temporary workspace as practical to allow for a wide excavation.

9. Beginning early in the morning, salvage the upper 0.5 m (minimum) of clean granular material, if present, and stockpile separately from the remainder of the trench spoil.
10. Excavate the trench as rapidly as practical. Create spoil containment sumps, if warranted, to keep spoil from flowing back into the stream channel.
11. Install the pipe.
12. Backfill the stream channel first by pushing the silted water back into the bank excavations. Pump or drain the bank excavations while progressively backfilling from the stream channel outward. Construct water containment sumps if warranted.
13. Complete backfill, leaving a small, shallow (<0.5 m) sump just upstream from the downstream dam. Install a pump intake in this sump.
14. Temporarily suspend pump bypass and/or slowly elevate corner of upstream dam and allow isolated channel to be flushed with water. Silt-laden water will flow into the shallow sump and then be pumped onto well-vegetated area.
13. Cap the upper 0.5 m (minimum) of the trench with the salvaged clean granular material.
14. Remove any accumulations of silt and sediment from the streambed.
15. Restore the bed banks of the stream channel to preconstruction profiles.
16. Remove the downstream dam or vehicle crossing plug then remove the upstream dam or vehicle crossing plug. Restore and stabilize bed and banks of stream channel to the preconstruction profiles.

Adapted from CAPP *et al.* (2005)

CONSTRUCTION TECHNIQUE – TYPICAL DAM AND PUMP



canadian
energy
pipeline
association

association
canadienne
de pipelines
d'énergie



Fourth Edition

November 2012

DWG. NO. 6

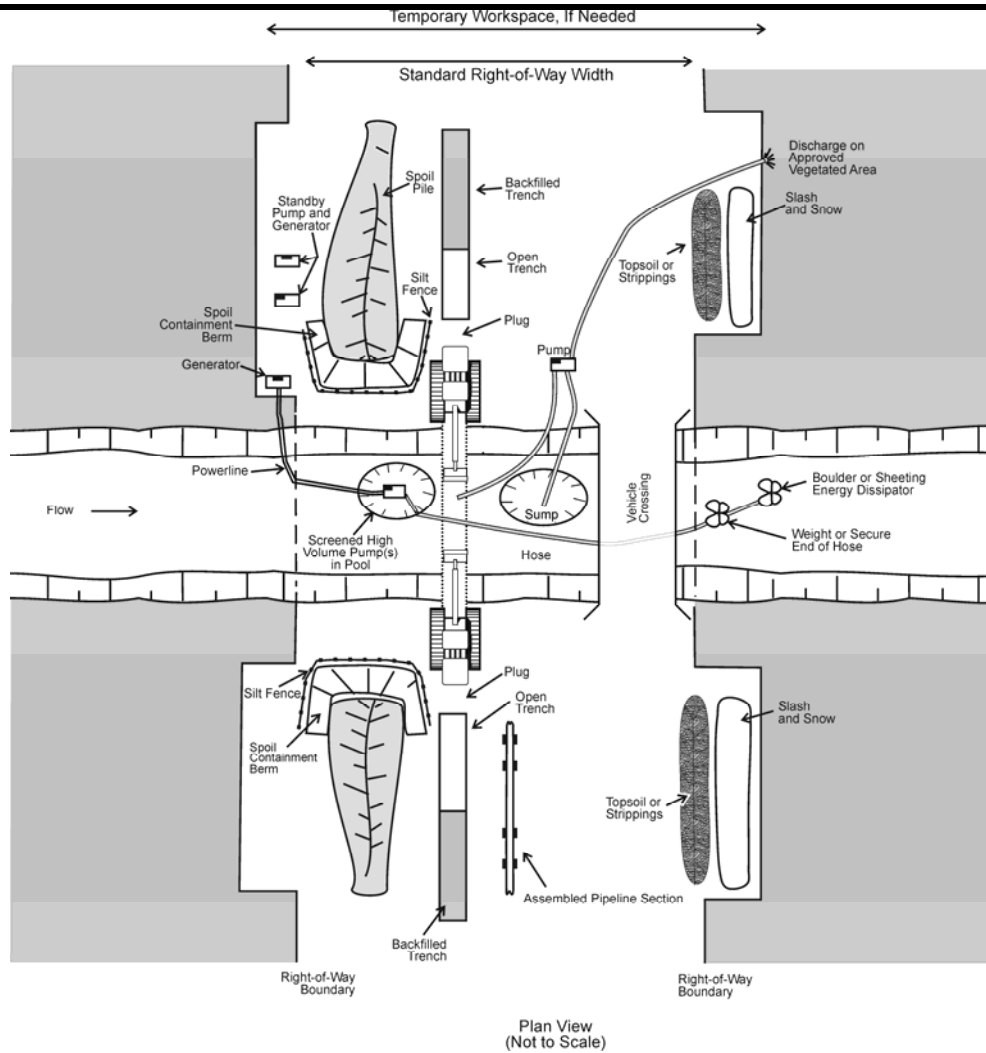

Notes:

1. Install vehicle crossing, if needed, on the work side edge of the right-of-way to allow for a wide excavation.
2. Ensure adequate electric power supply and adequately sized pumps to handle anticipated flow. Have standby pumps and generators capable of handling 100% of anticipated flow onsite and ready to be used if the operating pumps fail.
3. Install high volume pumps in pool located upstream of the excavation. Excavate temporary upstream sump in the right-of-way if no natural pool exists. Add additional pumping capacity, if needed. Discharge water through or into an energy dissipator into the channel sufficiently downstream of the trench to prevent water flowing back into the excavation.
4. Immediately initiate fish salvage from isolated pools. Ensure fish salvage permit(s) are acquired prior to installing pump.
5. Beginning early in the morning, salvage the upper 0.5 m (minimum) of clean granular material, if present, and stockpile separately from the remainder of the trench spoil.
6. Excavate a small sump downstream of crossing to collect silt laden waters. Install small pumps in sump and trench to discharge silt-laden water on to well vegetated soils away from watercourse.
7. Excavate trench, complete installation and backfill trench. Move hose, if warranted, to maintain streamflow.
8. Cap the upper 0.5 m (minimum) of the trench with the salvaged clean granular material.
9. Wash backfilled trench area into sump. Pump silt-laden water from trench onto a well vegetated area off right-of-way. Complete this step each evening prior to shutting off upstream pumps, if instream work is to occur on successive days.

Adapted from CAPP *et al.* (2005)

CONSTRUCTION TECHNIQUE – TYPICAL VOLUME PUMP BYPASS



canadian energy pipeline association / association canadienne de pipelines d'énergie



Fourth Edition

November 2012

DWG. NO. 7

A. Right Bank

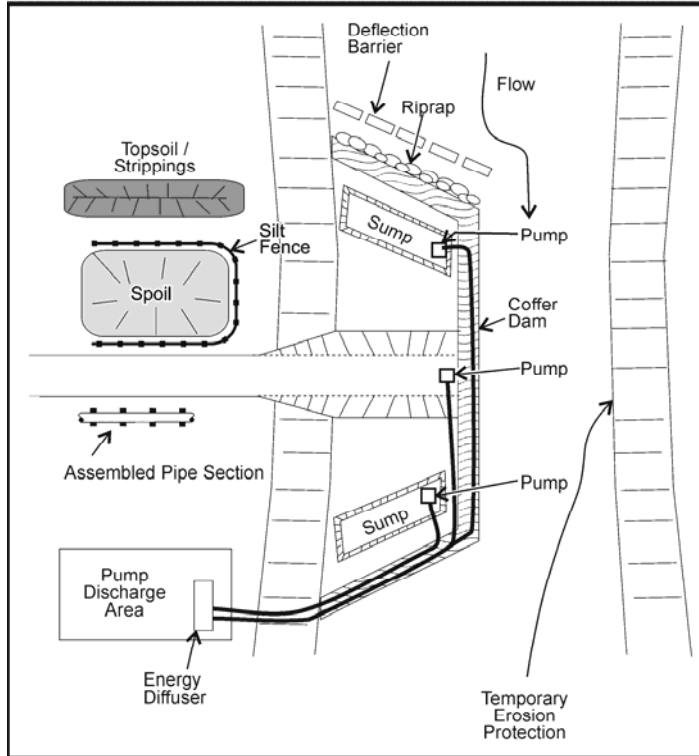

B. Left Bank

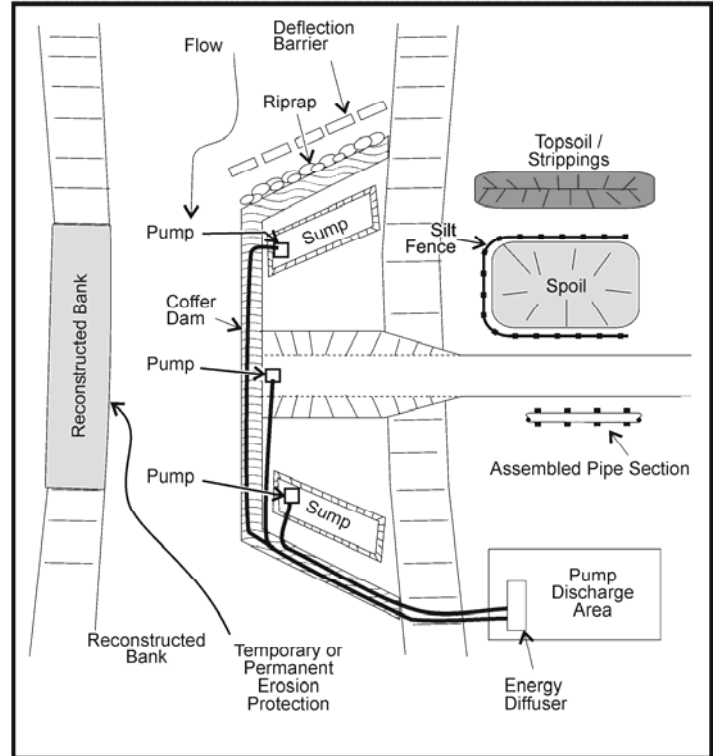

Plan View
(Not to Scale)

Notes:

1. A crossing-specific drawing to supersede this typical drawing should be prepared for implementation during construction.
2. Ensure sufficient working space within the coffer dam to accommodate a wide unstable ditch.
3. If there is a high velocity streamflow, install deflection barrier (e.g., median barriers) to permit construction of coffer dam outside of full streamflow.
4. Construct coffer dam from local materials, sandbags, 1 m³ sandbags, aquadams, sheet piling, median barriers, gravel or other appropriate material to extend over halfway across the watercourse.
5. Install impermeable barrier within coffer dam.
6. Install riprap on upstream side to protect the dam from erosion if dam is constructed of loose material.
7. Install sumps to collect seepage and then pump to dewatering area.
8. Ensure discharge area can handle the volume of water and silt pumped to shore.
9. Complete trenching, lowering in and backfilling; mark end of pipe.
10. Remove coffer dam, reconstruct bank.
11. Install similar structure on opposite side of watercourse enclosing the marked pipe end.

Adapted from TERA 1996

CONSTRUCTION TECHNIQUE – TYPICAL TWO STAGE COFFER DAMS



canadian
energy
pipeline
association

association
canadienne
de pipelines
d'énergie



Fourth Edition

November 2012

DWG. NO.8

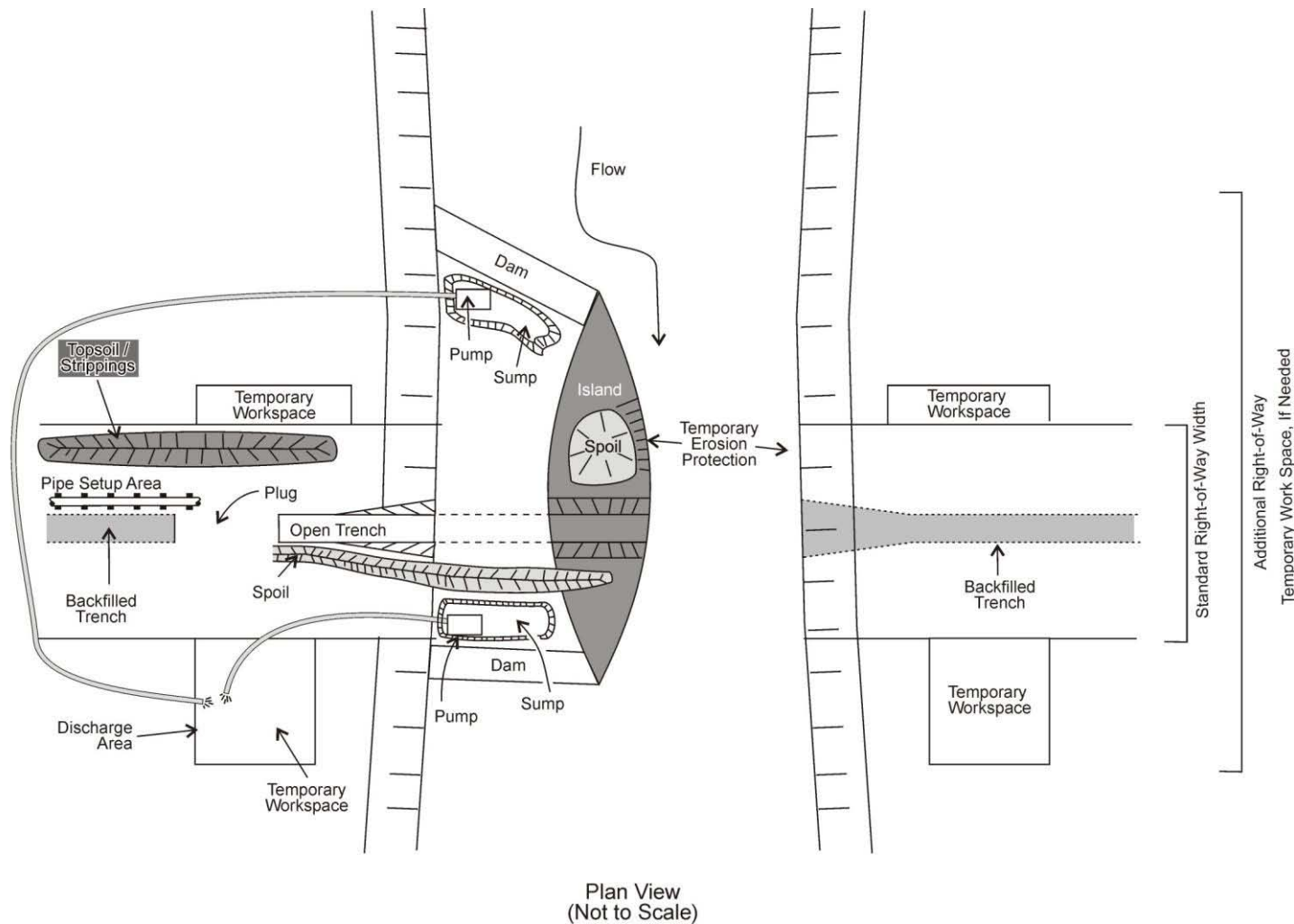

Notes:

1. If there is a high velocity streamflow, install deflection barrier (e.g., median barriers) to permit construction of dam outside full streamflow.
2. Construct dam from local materials, sandbags, 1 m³ sandbags, water-filled dams, sheet piling, median barriers, gravel or other appropriate material to extend over halfway across the watercourse.
3. Install impermeable barrier within dam.
4. Install riprap on upstream side to protect the dam from erosion if dam is constructed of loose material.
5. Spoil storage shall be above the high water mark or protected by erosion control measures to ensure that, when the water level rises after all flow has been channelized into one channel, spoil is not washed away.
6. Install sumps to collect seepage and then pump to dewatering area.
7. Ensure discharge area can handle the volume of water and silt pumped to shore.
8. Complete trenching, lowering in and backfilling.
9. Remove dam, reconstruct bank.
10. Repeat process for other channel.
11. Temporary diversion also may be made through abandoned channels as long as steps are taken to minimize a flush of sediment once the watercourse is redirected through the "new" channel.
12. Temporary diversion through a channel excavated into a flood plain is possible if lined or passed through a flexible conduit to prevent excessive erosion along the "new" channel.

Adapted from TERA 1996

CONSTRUCTION TECHNIQUE – TYPICAL CHANNEL DIVERSION



canadian
energy
pipeline
association

association
canadienne
de pipelines
d'énergie



Fourth Edition

November 2012

DWG. NO. 9

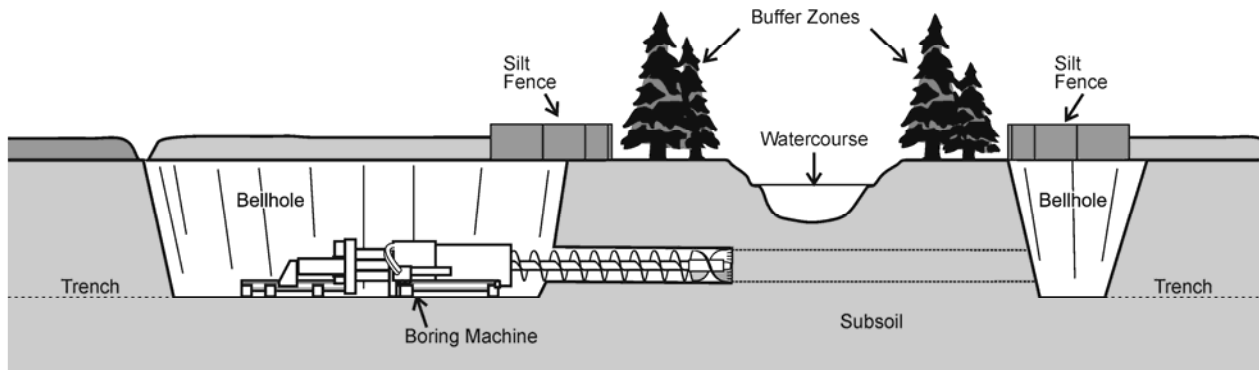
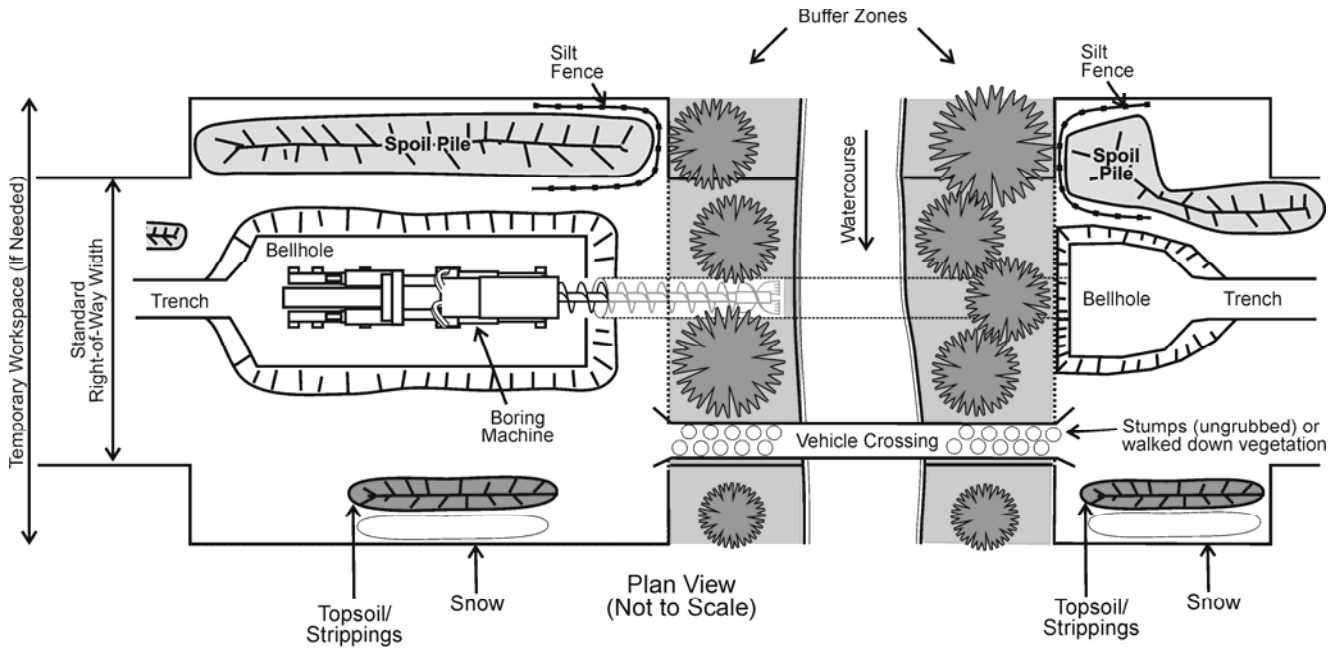

Profile
(Not to Scale)

Notes:

1. Acquire and mark additional temporary workspace.
2. Set up equipment back from the edge of the watercourse; do not clear or grade within vegetated buffer zone except along the work side if a temporary vehicle crossing is to be installed.
3. Excavate bellhole. Store spoil on side of right-of-way.
4. Complete boring and tie-in to mainline.
5. Pump bellhole dry if seepage becomes a problem. Dewater bellholes onto stable, vegetated land, not directly back into watercourse.
6. Backfill and compact. Leave a trench crown to allow for subsidence.
7. Reseed and fertilize as appropriate.

Adapted from CAPP *et al.* (2005)

CONSTRUCTION TECHNIQUE – TYPICAL BORE OR PUNCH



canadian
energy
pipeline
association

association
canadienne
de pipelines
d'énergie



Fourth Edition

November 2012

DWG. NO. 10

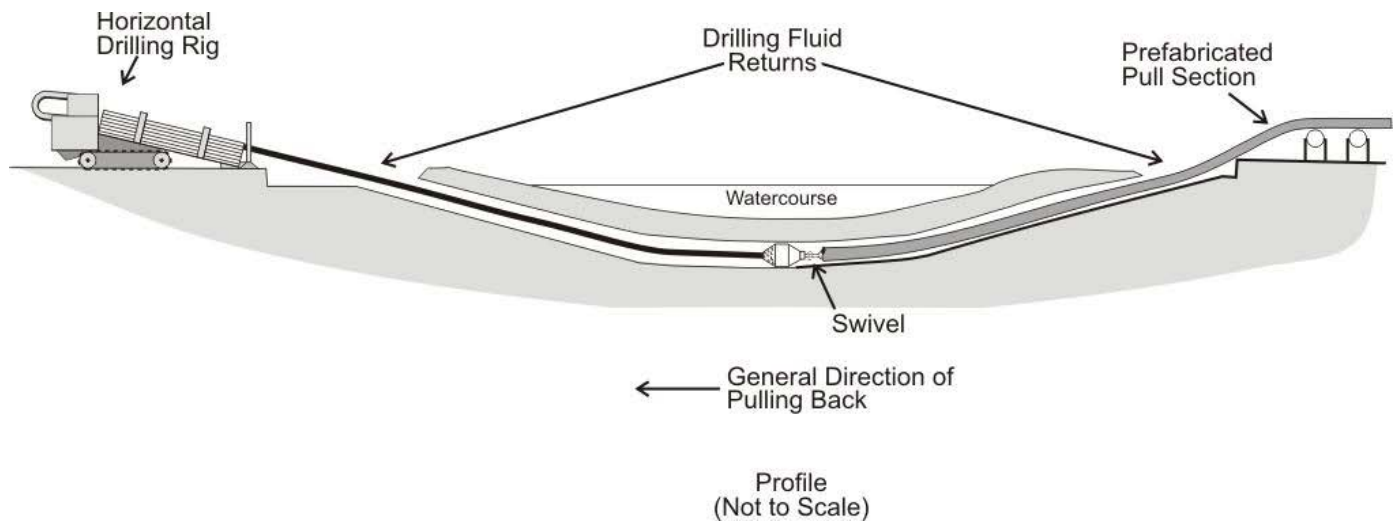

Notes:

1. Obtain geotechnical data prior to initiating drilling. Drilling may not be feasible in some materials such as unconsolidated gravels.
2. Ensure temporary workspace rights have been obtained to conduct monitoring and that access is available for monitoring activities.
3. Set up drilling equipment back from the edge of the watercourse; do not clear or grade within the vegetated buffer zone, except along the work side, if a temporary vehicle crossing is to be installed.
4. Employ full time inspectors to observe for an inadvertent mud release into the watercourse.
5. Ensure that only bentonite based drilling mud is used. Do not allow the use of any additives to the drilling mud without the approval of appropriate regulatory authorities.
6. Install suitable drilling mud tanks or sumps to prevent contamination of the watercourse.
7. Install sumps downslope from the drill entry and anticipated exit points to contain any release of drilling mud.
8. Dispose of drilling mud in accordance with the appropriate regulatory authority requirements.
9. Prepare a drilling mud release contingency plan.

Adapted from CAPP *et al.* (2005), ASCE (1996)

CONSTRUCTION TECHNIQUE – TYPICAL HORIZONTAL DIRECTIONAL DRILL



canadian
energy
pipeline
association

association
canadienne
de pipelines
d'énergie



Fourth Edition

November 2012

DWG. NO. 11a

(A) Typical Rig Side Workspace

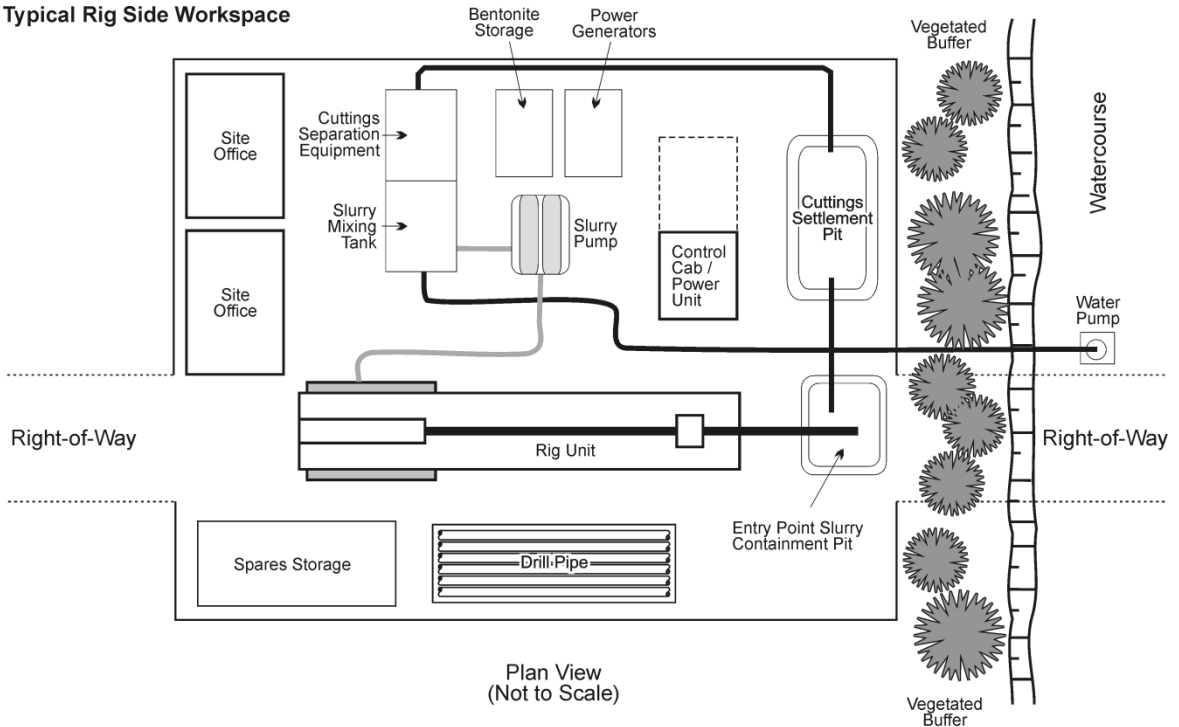

(B) Typical Pipe Side Layout

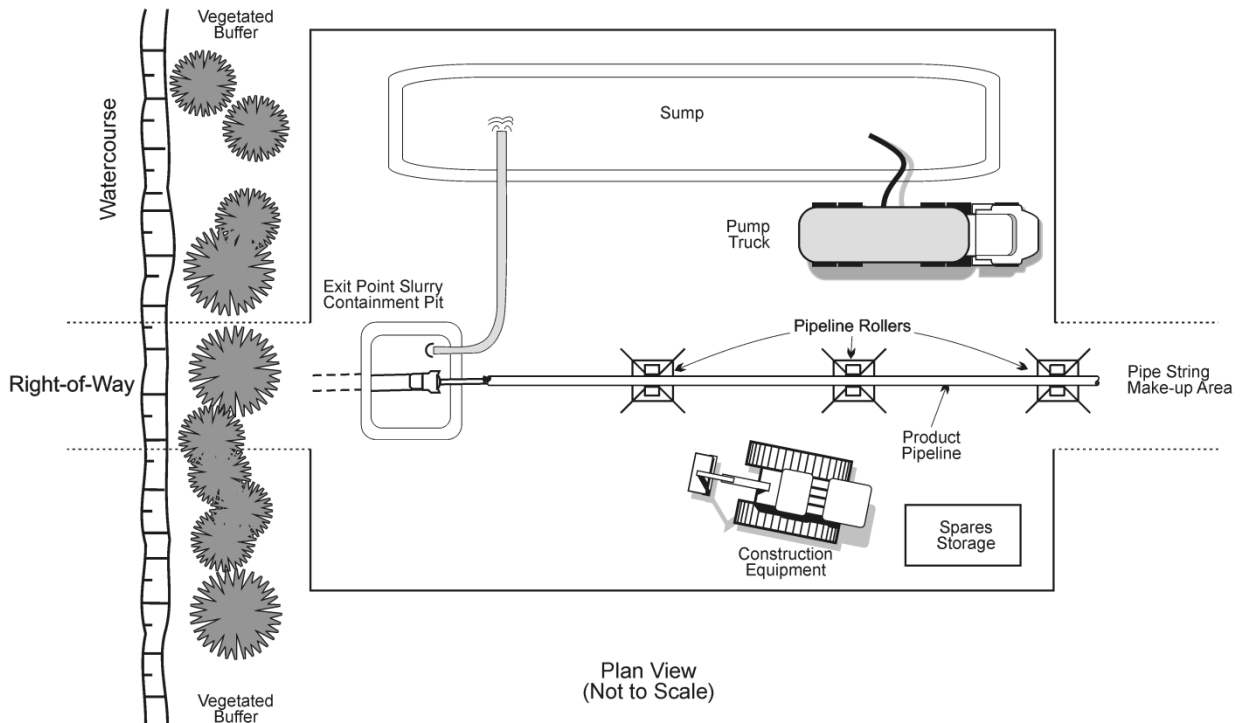

Adapted from CAPP et al. (2005), ASCE (1996)

CONSTRUCTION TECHNIQUE – TYPICAL HORIZONTAL DIRECTIONAL DRILL



canadian energy pipeline association / association canadienne de pipelines d'énergie



Fourth Edition

November 2012

DWG. NO. 11b

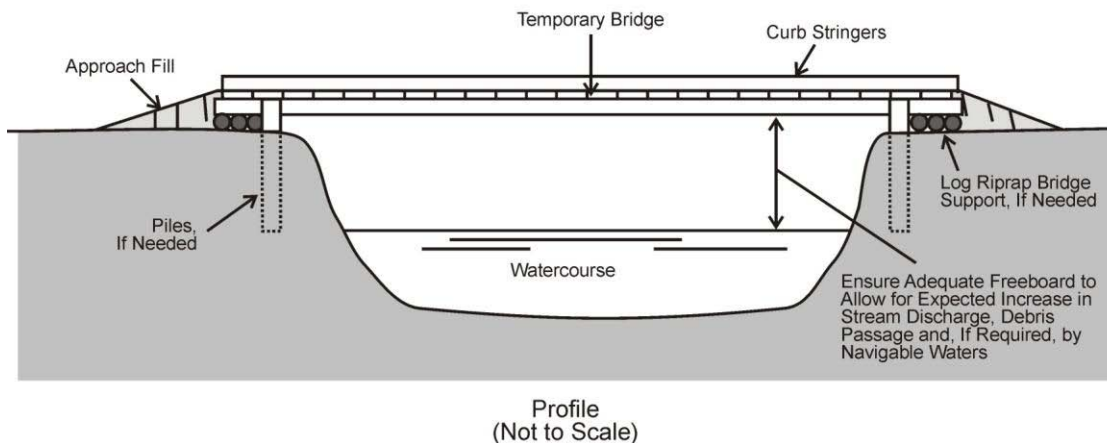
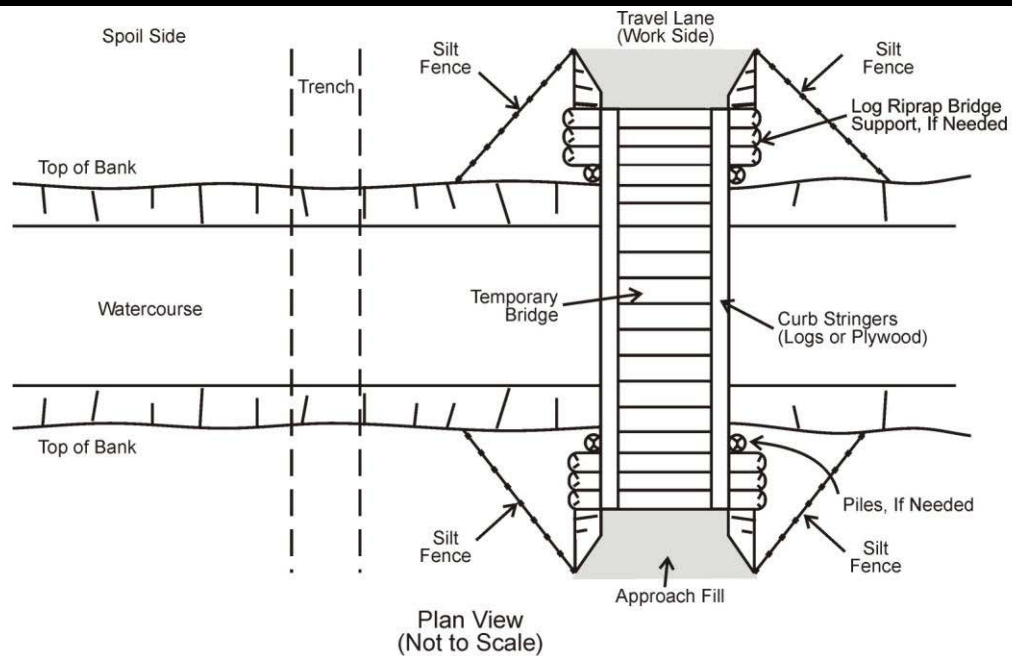

Notes:

1. Install a temporary bridge (e.g., log, pre-fabricated span) to allow vehicles to cross a watercourse that is sensitive or has unstable bed and banks. Bridges are also used where watercourses are too deep, wide or fast to permit an alternative crossing structure. This method reduces sedimentation of the watercourse, and bank and bed restoration work. It is generally limited to watercourses less than 30 m in width.
2. Utilize approach fills rather than cuts in banks to reduce erosion potential. Do not constrict flow with approach fill or support structures. Ensure adequate free-board to handle anticipated streamflows. Use a geotextile liner to prevent fine material from entering the watercourse.
3. Install curb stringers of logs or plywood to ensure that fill material does not spill into the watercourse, where needed.
4. Remove the bridge immediately after use. If the bridge is to remain in place through spring break-up to provide access during final clean-up, it must be designed for spring floods and ice jams. Remove support structures and approach fills. Restore and stabilize the banks.

Adapted from CAPP *et al.* (2005)

VEHICLE CROSSING – TYPICAL TEMPORARY BRIDGE



canadian energy pipeline association / association canadienne de pipelines d'énergie



Fourth Edition

November 2012

DWG. NO. 12

A. Plan View

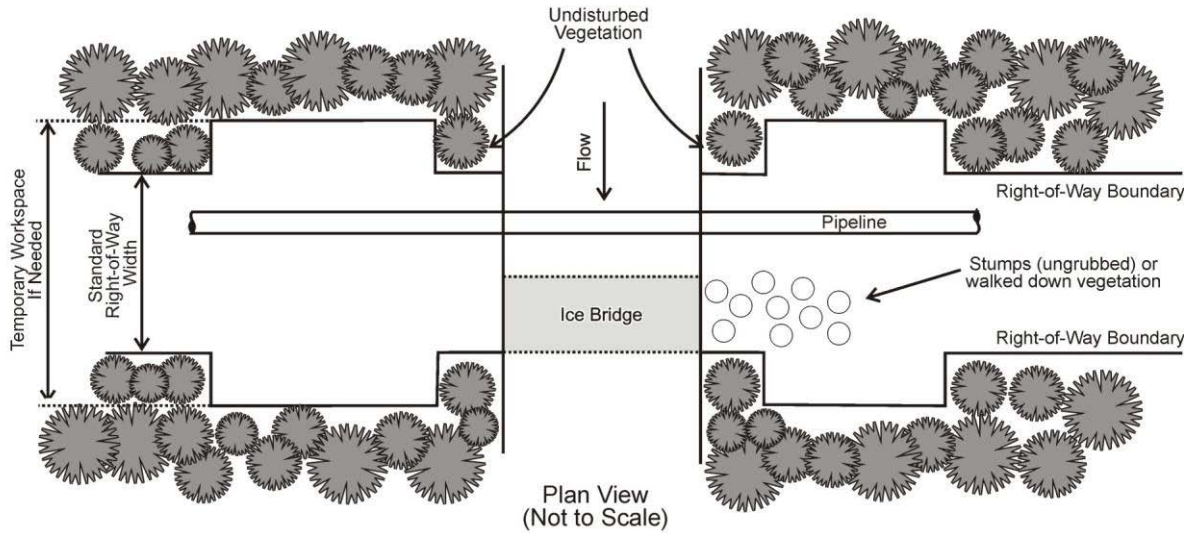

B. Profile View

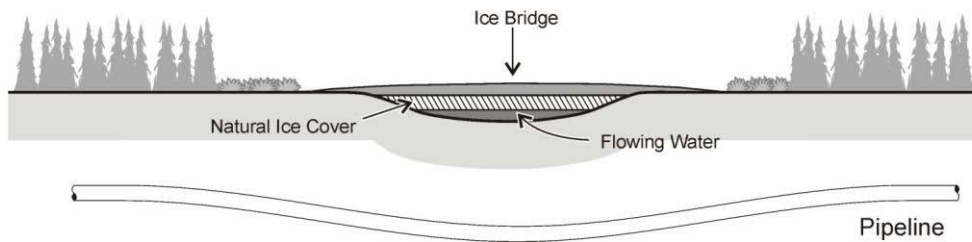

Notes:

1. Install ice bridges on winter projects when a safe ice thickness can be maintained.
2. Locate ice bridges at sites with gently sloping banks to avoid cuts in watercourse banks. Use snow and ice to slope approaches, rather than cut banks.
3. Flood ice surface with water and cover with snow to increase load bearing capacity. Logs may be used as a base to strengthen the bridge. The ice bridge should not impede flow.
4. Maintain ice regularly and remove all debris from the ice surface.
5. Remove broken ice from trench area to prevent ice jamming against and under the ice bridge.
6. Create a v-notch in the centre of the ice bridge when crossing activities are complete to allow it to melt from the centre and to prevent blocking fish passage, channel erosion and flooding.
7. Remove logs, if used, and breach the ice bridge by physical means prior to spring break-up.
8. Restore and stabilize the banks and approaches prior to spring break-up.

Source: Adapted from CAPP *et al.* (2005)

VEHICLE CROSSING – TYPICAL ICE BRIDGE



canadian
energy
pipeline
association

association
canadienne
de pipelines
d'énergie



Fourth Edition

November 2012

DWG. NO. 13

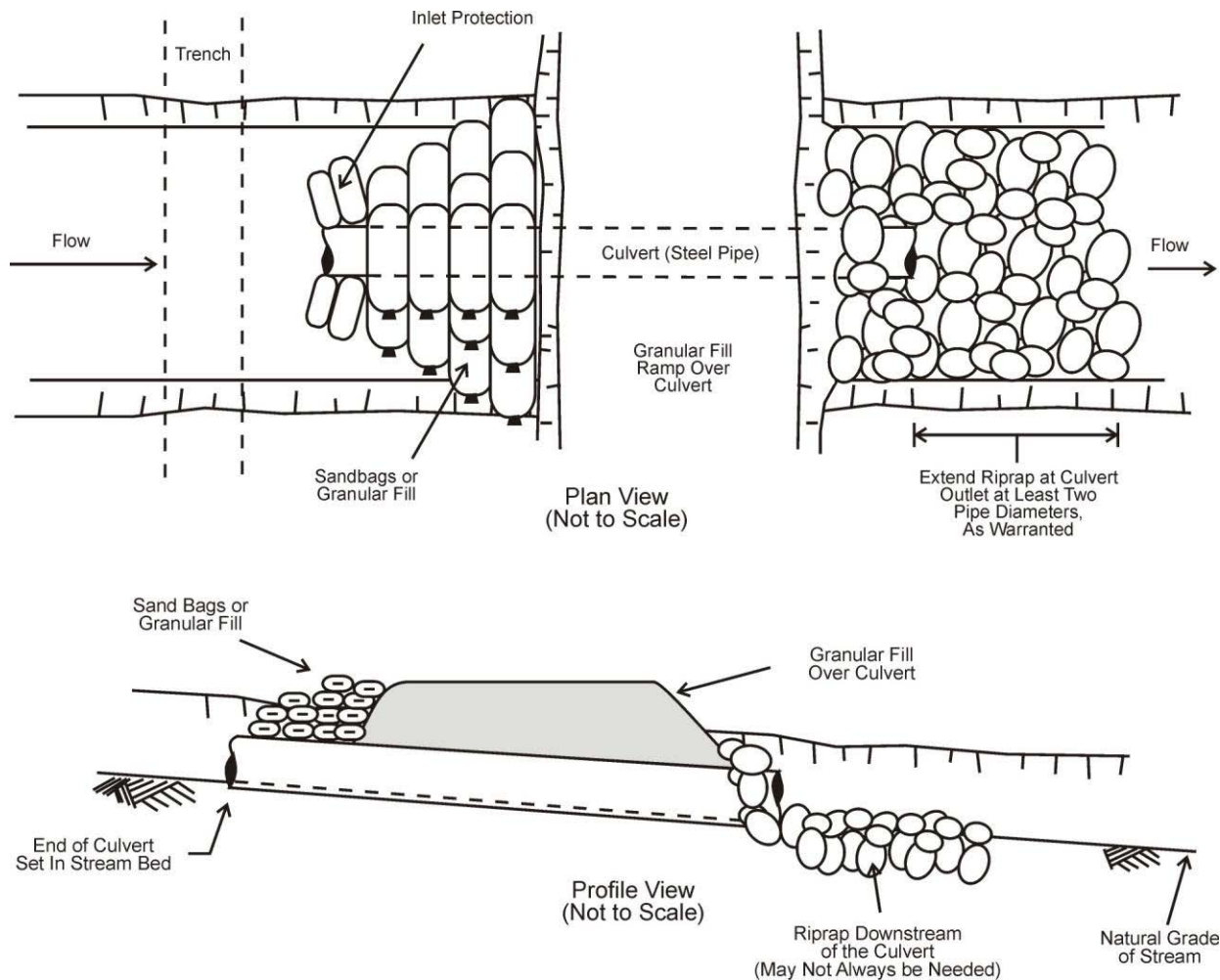

Notes:

1. Install ramp and culverts to allow vehicles to cross relatively narrow watercourses with limited or no flow.
2. Design culverts to handle 150% of maximum anticipated flows or to a five year flood level and according to specific guidelines where fish passage (*i.e.*, migration) is required. Contact government authorities for minimum water depth specifications, and maximum water velocities. Ensure dam is impermeable.
3. Place ends of culverts below the natural grade of watercourse at an angle that does not exceed normal watercourse gradient. Depth of placement is dependent upon bed type, culvert size and expected flow conditions.
4. Remove temporary culverts and ramp materials when no longer required. Remove culvert and ramp prior to freeze-up (summer construction) and prior to spring break-up (winter construction).
5. Restore and stabilize the bed and banks.

Source: Adapted from Alliance (1998)

VEHICLE CROSSING – TYPICAL RAMP AND CULVERT



canadian energy pipeline association / association canadienne de pipelines d'énergie



Fourth Edition

November 2012

DWG. NO. 14

A. Plan View

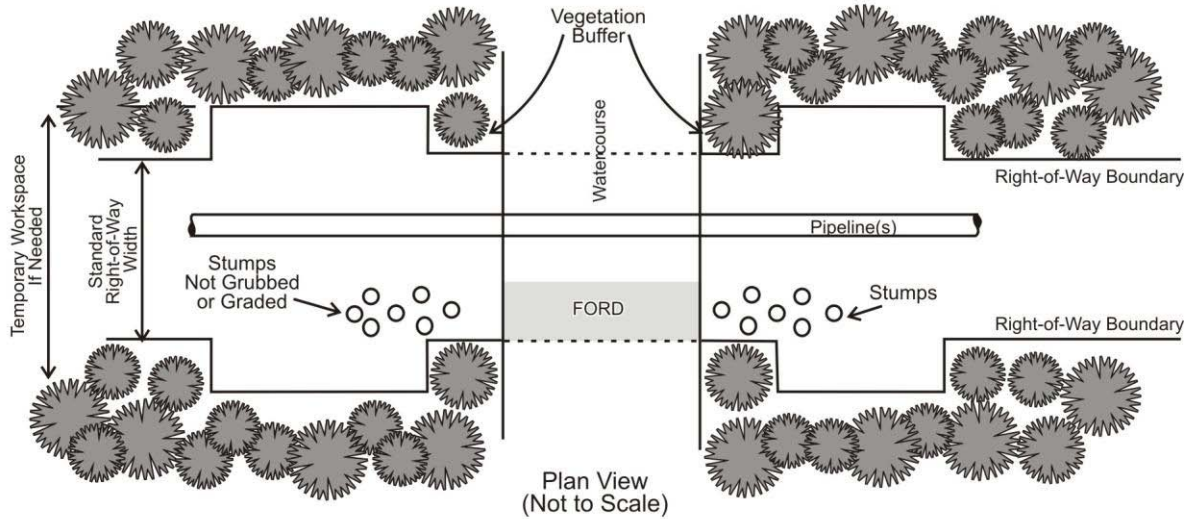

B. Profile View

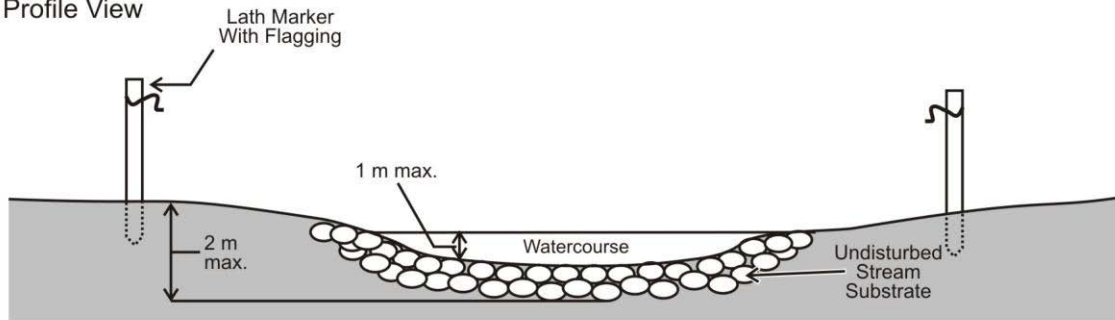

Notes:

1. Use fords to provide vehicular access across relatively shallow (less than 1 m) and narrow watercourses with granular beds and stable banks. Where water depth, streambed composition or banks slopes could pose trafficability problems for rubber tired vehicles, limit ford traffic to tracked equipment.
2. Do not use ford during fish spawning, incubation or migration periods.
3. Limit grading in proximity to watercourse. Grade and grub only along the trench line and pull soil and debris away from watercourse, if grading of the banks is necessary. No grading of the banks will be allowed to facilitate the use of a ford unless the ford is to be located on the trench line.
4. Limit the use of the ford; and, if the potential for damage to the bed and banks exists, prohibit use of the ford by rubber tired traffic.
5. Stabilize banks and approaches with granular blanket underlain by a geotextile, if warranted.
6. Mark boundaries of ford on both sides of crossing to confine all vehicle traffic to ford.
7. Restore and stabilize the beds and banks to the preconstruction profile when ford is no longer needed. The granular blanket, if used, need not be removed if it is not a barrier to fish during low flow conditions. However, remove both the granular blanket and underlying geotextile where geotextile has been used.

Source: Adapted from CAPP *et al.* (2005)

VEHICLE CROSSING – TYPICAL FORD



canadian energy pipeline association / association canadienne de pipelines d'énergie



Fourth Edition

November 2012

DWG. NO. 15

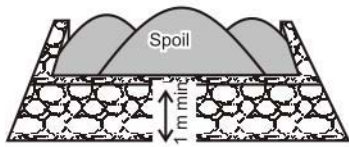

1. Windrow Boulders and Shot Rock

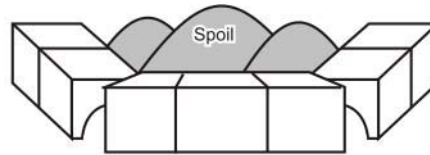

2. Saddle Weights

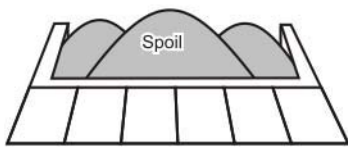

3. Subsoil Berm

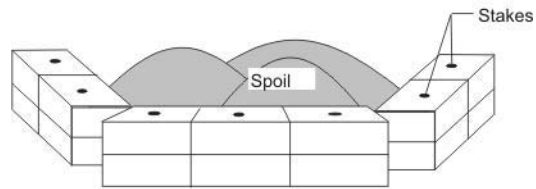

4. Straw Bales (staked)

Not to Scale

Notes:

1. Construct sump or berms, where warranted, to contain excavated instream spoil so that silty runoff does not enter a watercourse or flow off right-of-way.
2. Strip topsoil from area to be used as spoil storage.
3. Maintain a sufficient vegetated buffer from the top of the streambank.
4. Berms that do not adequately prevent leakage, such as those made of boulders, shotrock or saddle weights may need a geotextile liner to prevent silty water from entering a watercourse.

Adapted from CAPP *et al* (2005), Alliance (1997)

SEDIMENT CONTROL – TYPICAL SPOIL BERMS



canadian
energy
pipeline
association

association
canadienne
de pipelines
d'énergie



Fourth Edition

November 2012

DWG. NO. 16

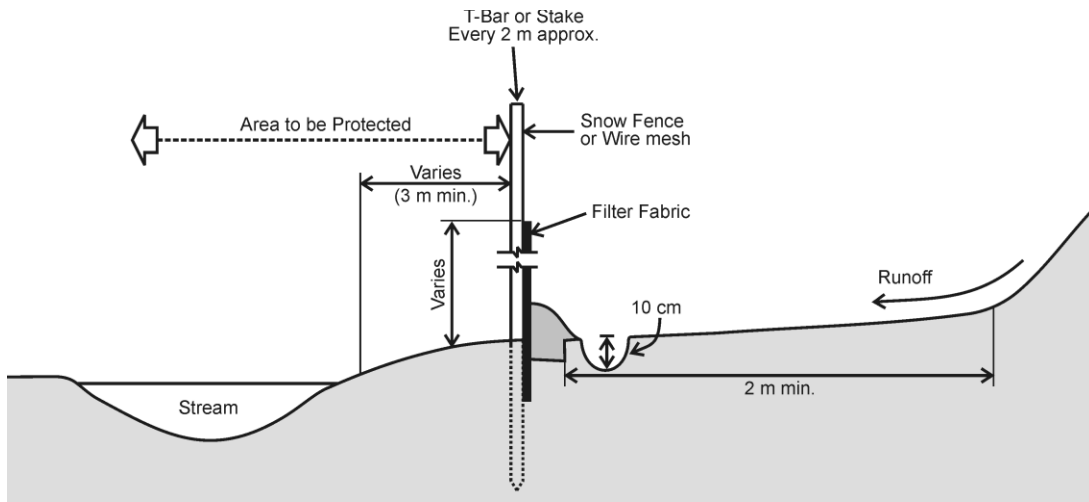

Side View of Silt Fence
(Not to Scale)

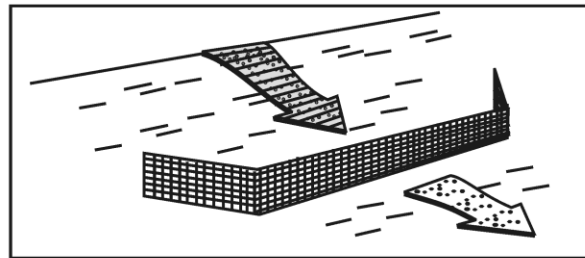

Oblique View
(Not to Scale)

Notes:

1. Watercourses that have moderate to high sensitivity of fish habitat and/or have steep approach slopes at the proposed crossings may need silt fences during construction, as determined by the Environmental Inspector.
2. Install silt fences at the base of approach slopes following clearing and grading using the method and materials noted above or other approved designs.
3. Ensure the silt fence is keyed into the substrate. Excavate a narrow trench, place the base of the silt fence in the trench and place the fill back into the trench, securing the silt fence in place.
4. Place silt fences a minimum 2 m, if feasible, from the toe of the slope in order to increase ponding volume.
5. Maintain silt fences throughout construction.
6. Ensure that silt fences, if removed or damaged, are reinstalled or repaired prior to the end of the work day.
7. Maintain silt fences in place at the base of the approach slope(s) until revegetation of the right-of-way is complete.
8. In areas with frequent traffic, install two or more silt fences in a staggered and overlapped configuration to allow vehicle passage without removal or opening of the silt fence.

Adapted from CAPP *et al* (2005), Alliance (1997)

SEDIMENT CONTROL – TYPICAL SILT FENCES



canadian
energy
pipeline
association
association
canadienne
de pipelines
d'énergie



Fourth Edition

November 2012

DWG. NO. 17

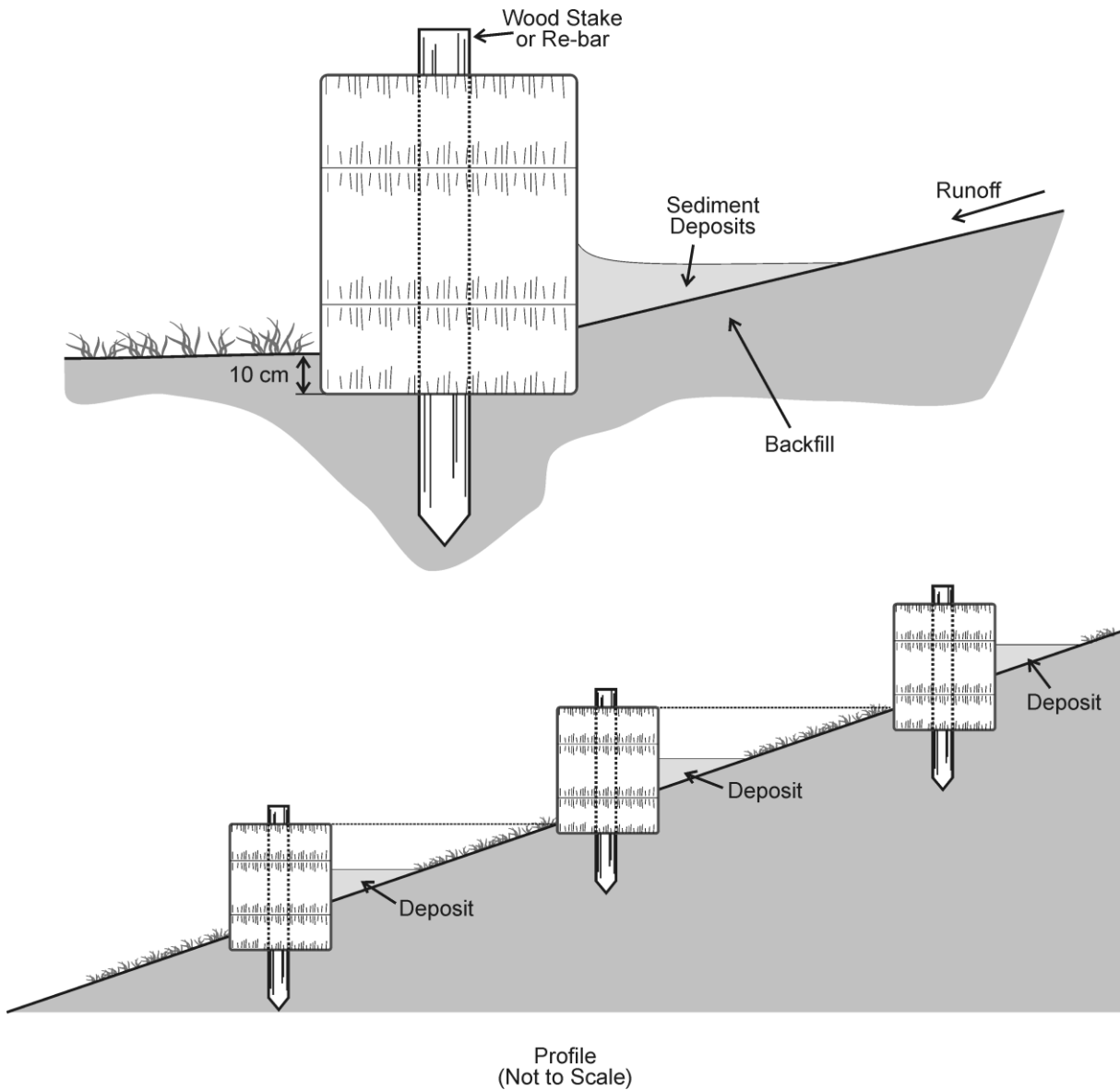

Notes:

1. Construct straw bale filters to contain excavated instream spoil so that silty run off does not enter watercourse or flow off right-of-way.
2. Use straw bale filters on long unprotected slopes to prevent surface erosion from entering watercourse.
3. Where several lines of bales are installed on a slope in a more permanent application, erosion will be minimized if the top of the downslope bale is on the same level as the bottom of the next line up.

Adapted from CAPP *et al* (2005)

SEDIMENT CONTROL – TYPICAL STRAW BALES



canadian energy pipeline association
association canadienne de pipelines d'énergie



Fourth Edition

November 2012

DWG. NO. 18

Sack Breaker

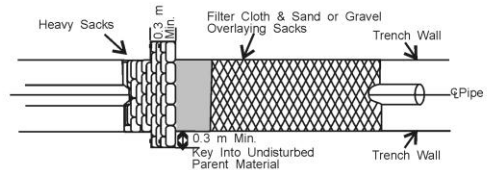
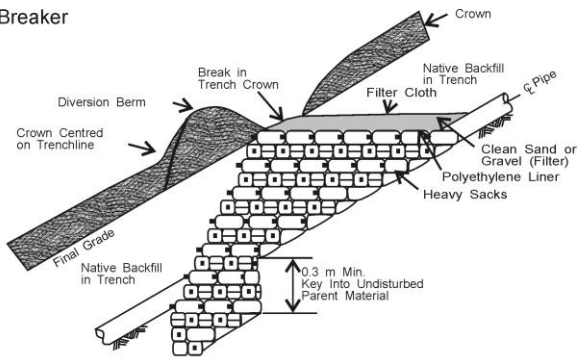

Foam Breaker

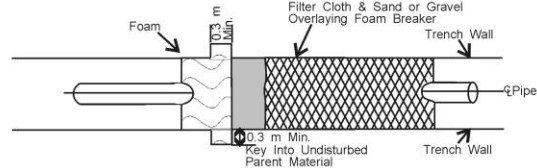
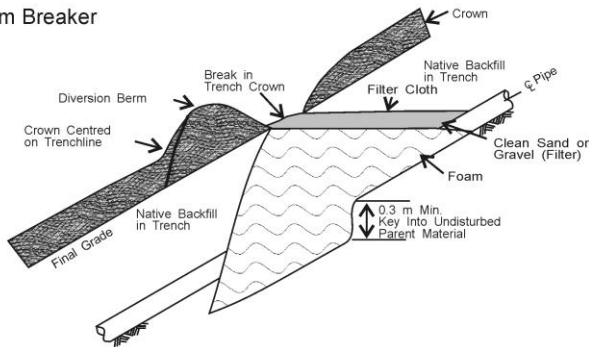

Bentonite Breaker

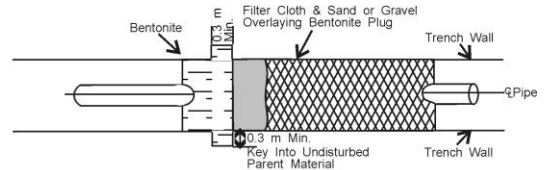
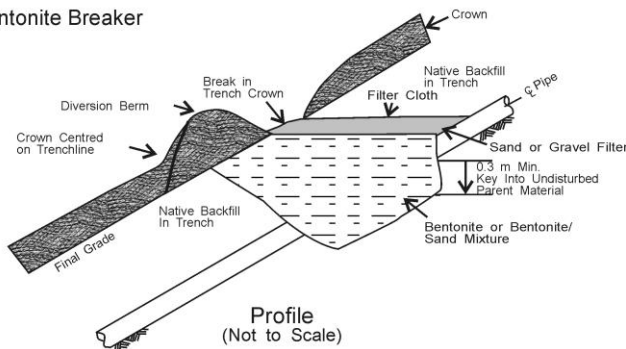

Notes:

1. Install trench breakers to control water seepage along the trench line and prevent erosion of backfill materials.
2. Trench breakers may be constructed using earth filled sacks, bentonite, foam or equivalent materials to provide a barrier to water seepage.
3. The drawings above provide a schematic representation of trench breaker installation. Final locations and design of trench breakers will be determined by the project engineer based on site-specific conditions at the time of construction.
4. Dig keys into the trench bottom and sides to the extent feasible for added stability.
5. Install a prefabricated drain or a layer of sand or gravel covered with filter cloth over the breaker.
6. Backfill native material and mark location of breaker.
7. Ensure cross ditches are located over the end of the drain.
8. Construct diversion berms downslope from the breaker but not over the end of the drain.
9. Ensure that the trench crown does not encroach upon the breaker drain or cross ditch.
10. Backfill the trench on downslope side of breaker before upslope side.

Adapted from Alliance (1997)

SUBSURFACE DRAINAGE CONTROL – TYPICAL TRENCH BREAKERS



canadian
energy
pipeline
association

association
canadienne
de pipelines
d'énergie



Fourth Edition

November 2012

DWG. NO. 19

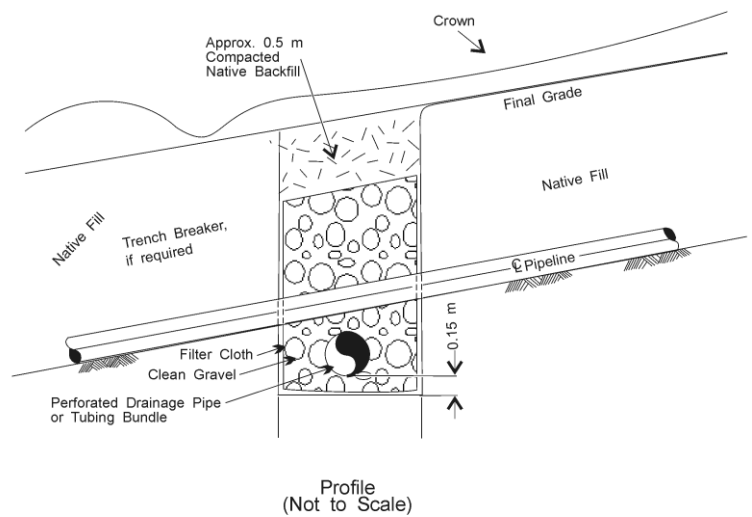
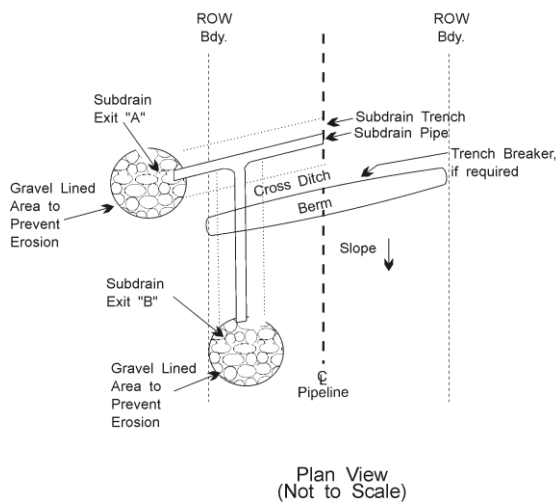

Notes:

1. Install a subdrain to divert shallow groundwater flow away from the pipeline, to improve slope stability. Clean gravel and a filter cloth ditch liner, permits drainage aiding in retention of backfill. In certain circumstances, a parallel drain may be installed lengthwise down the slope underneath the pipeline. A geotechnical engineer can advise as to which method is most appropriate.
2. Install a trench breaker downslope of the subdrain, where drains cross pipeline trench, to prevent drain water flowing down pipe trench.
3. Determine the location of drain by onsite investigation considering such factors as groundwater conditions in trench, soil types, local topography, and drainage patterns. Discharge may either be off right-of-way on the downslope side of the subdrain (see Subdrain Exit "A"), or on right-of-way upslope of the berm (see Subdrain Exit "B"). Special permission will be required from the appropriate regulatory authority and landowner to construct a subdrain exit off right-of-way. Ensure discharge is into a well protected area with gravel, rock riprap or vegetation.
4. Skew cross drain 5 off horizontal to ensure sufficient drainage.
5. The above drawings are schematic diagrams. A geotechnical engineer should be consulted for the detailed site-specific drain design and the incorporation of the trench breaker.

Adapted from Alliance (1997)

SUBSURFACE DRAINAGE CONTROL – TYPICAL SUBDRAIN



canadian energy pipeline association / association canadienne de pipelines d'énergie



Fourth Edition

November 2012

DWG. NO. 20

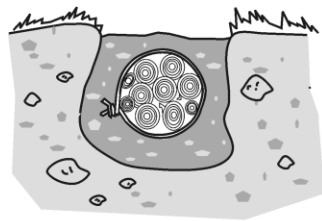

Profile
(Not to Scale)

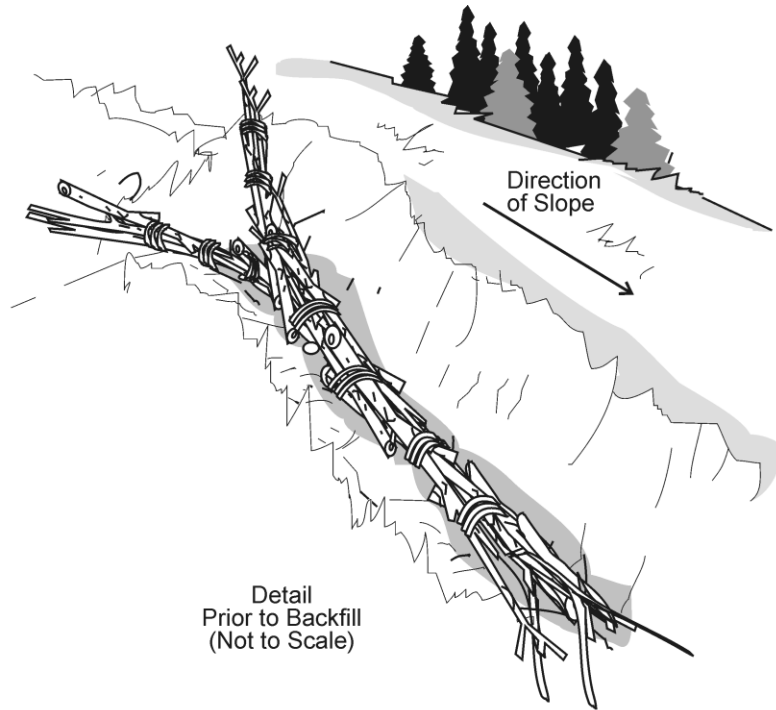

Detail
Prior to Backfill
(Not to Scale)

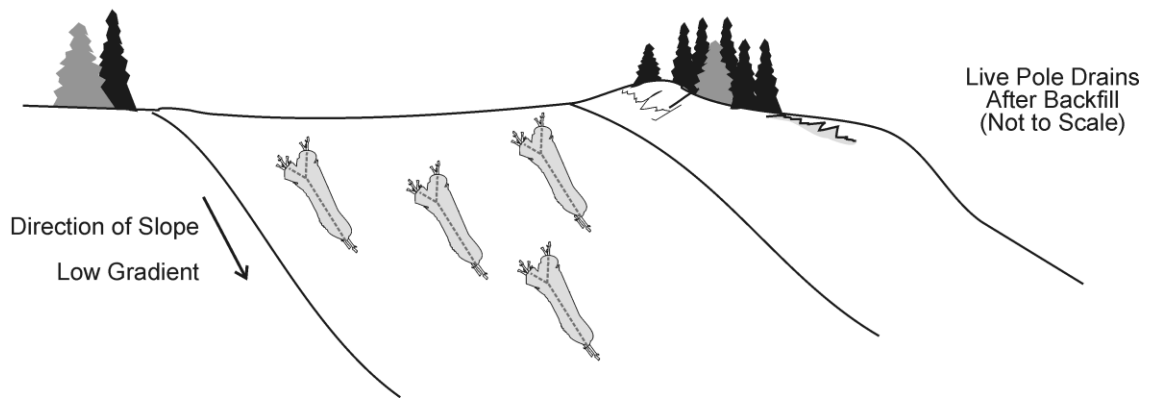

Live Pole Drains
After Backfill
(Not to Scale)

Notes:

1. Excavate a shallow trench parallel with the slope and within regions of excessive moisture.
2. Construct a bundle of willow cuttings, alternating tips and butts, by tying with twine as tightly as practical. Twigs and branches should not be trimmed unless inhibiting the tightness of the bundle.
3. Backfill over the bundle except for bundle ends. Tamp to compact the soil. The bundles may be anchored or staked on erosion prone slopes.

Adapted from CAPP *et al.* (2005)

SUBSURFACE DRAINAGE CONTROL – TYPICAL POLE DRAINS



canadian
energy
pipeline
association

association
canadienne
de pipelines
d'énergie



Fourth Edition

November 2012

DWG. NO. 21

Profile
(Not to Scale)

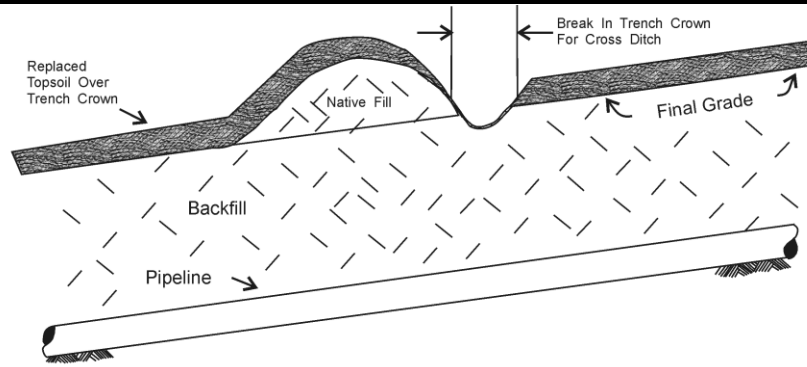

Plan View
(Not to Scale)

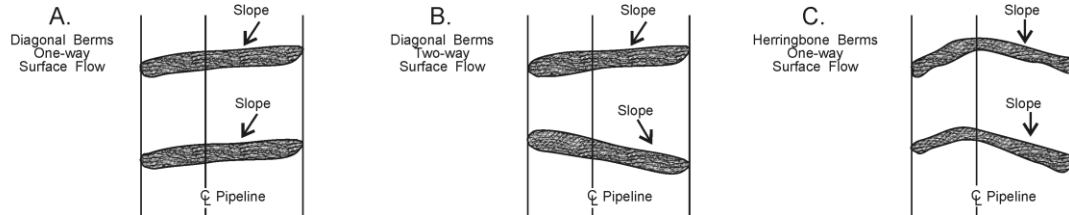

Notes:

1. Install diversion berm and cross ditch on moderate and steep slopes to divert surface water off the right-of-way. Install berms immediately downslope of trench breakers to collect seepage forced to the surface.
2. Skew berm across the right-of-way at downhill gradient of 5-10%.
3. Construct diversion berm of compacted native subsoils where extensive disturbance of the sod layer has occurred. Diversion berms should be constructed of timbers, imported logs or sandbags if disturbance of the sod layer is limited. Avoid use of organic material. Where native material is highly erodible, protect upslope of berm and base of cross ditch by burying a geotextile liner 16-20 cm below the surface or armour upslope face of berm with earth-filled sand bags.
4. Typical diversion berm height is approximately 0.75 m [summer] and 1.0 m [winter]. Inspect berms after heavy rains and the first spring following construction; replace or restore berms, if warranted.
5. Leave a break in trench crown immediately upslope of diagonal berm and cross ditch to allow passage of water across the right-of-way.
6. Use diagonal berms where direction of slope and surface water movement is oblique to the pipeline right-of-way.
7. Use herringbone berm and cross ditch where direction of slope and surface water movement are parallel to the right-of-way so runoff does not cross ditchline.
8. Determine the location and direction of berm based on local topography and drainage patterns. Also install berms immediately downslope of trench breakers. Skew berms with a downhill gradient of 5-10%.
9. Typical diversion berm spacing is indicated below.

Slope Gradient (° :%)	Typical Spacing (m) Erosion Hazard*		
	High	Medium	Low
<7; <12	30-45	45-60	60 or more
7; 12	25	38	51
8; 14	22	33	44
9; 16	19	29	38
11; 19	16	24	32
14; 25	12	18	24
18; 33	9	14	18
27; 50	6	9	12

* High = fine sand silts; medium = clays and coarse sands; low = rock or gravel

.Adapted from Alliance 1997

SURFACE EROSION CONTROL – TYPICAL CROSS DITCHES AND DIVERSION BERMS



canadian energy pipeline association / association canadienne de pipelines d'énergie



Fourth Edition

November 2012

DWG. NO. 22

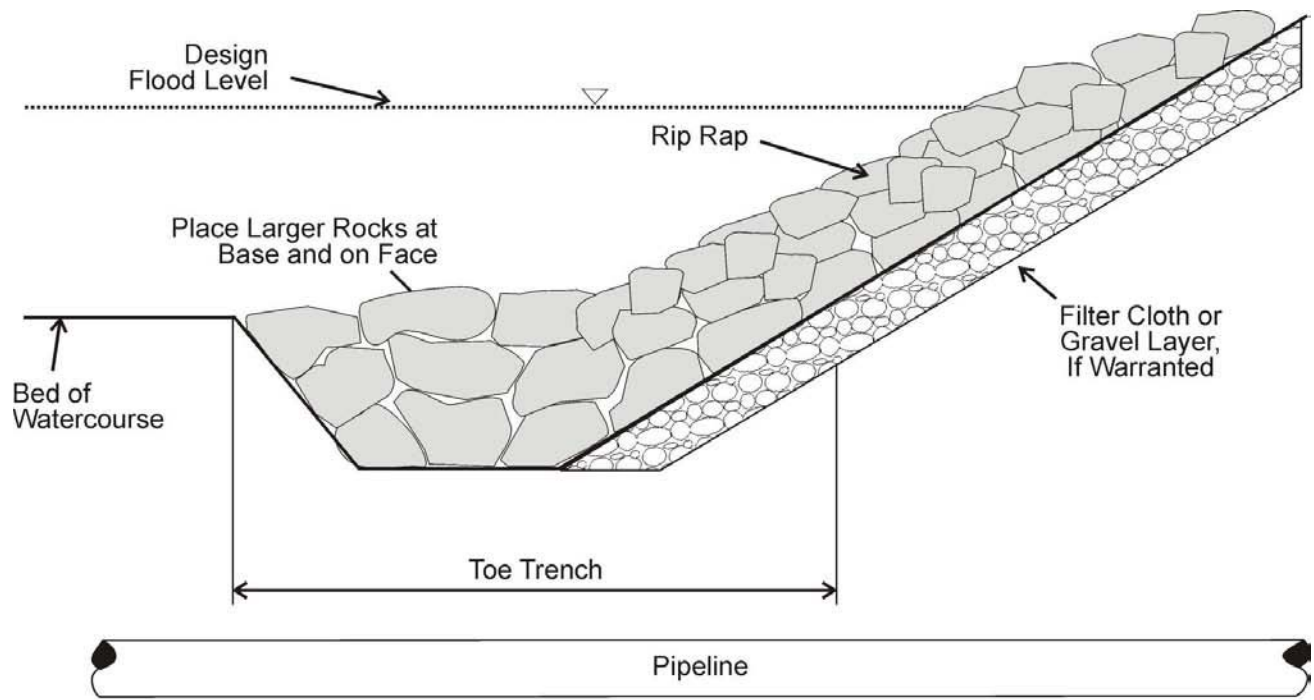

Profile
(Not to Scale)

Notes:

1. Proper placement and design are critical, and qualified specialists should be involved.
2. Remove all stumps, organic matter and work material, then grade/prepare banks to a maximum slope as directed by a geotechnical engineer.
3. Construct toe trench to key in bottom of armour protection, or adopt thickened toe option.
4. Install filter cloth (geotextile) or gravel filter layer.
5. Place washed riprap on the slope to be protected such that a well-interlocked, smooth layer is produced.
6. Rock riprap should be dense, durable, roughly equidimensional (not flat and thin), angular and clean.
7. Size of riprap used is dependent upon the slope of bank and water velocity.
8. Ensure that the minimum thickness of a riprap layer is 1.5 to 2 times the approximate dimensions of rock being used.
9. Key in up and downstream ends of the armoured bank in a manner such that it will not be outflanked.
10. Extend riprap 0.5 m (min) above design flood level. If the design flood level is above the top of the bank, riprap should be placed to the top of the bank.
11. Riprap is to be flush with the bank adjacent to the right-of-way.

Adapted from Alliance (1998)

STREAMBANK PROTECTION – RIP RAP ARMOUR



canadian
energy
pipeline
association

association
canadienne
de pipelines
d'énergie



Fourth Edition

November 2012

DWG. NO. 23

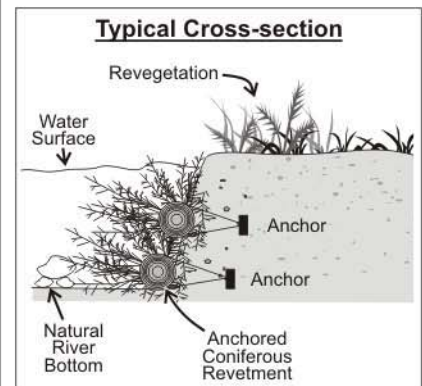
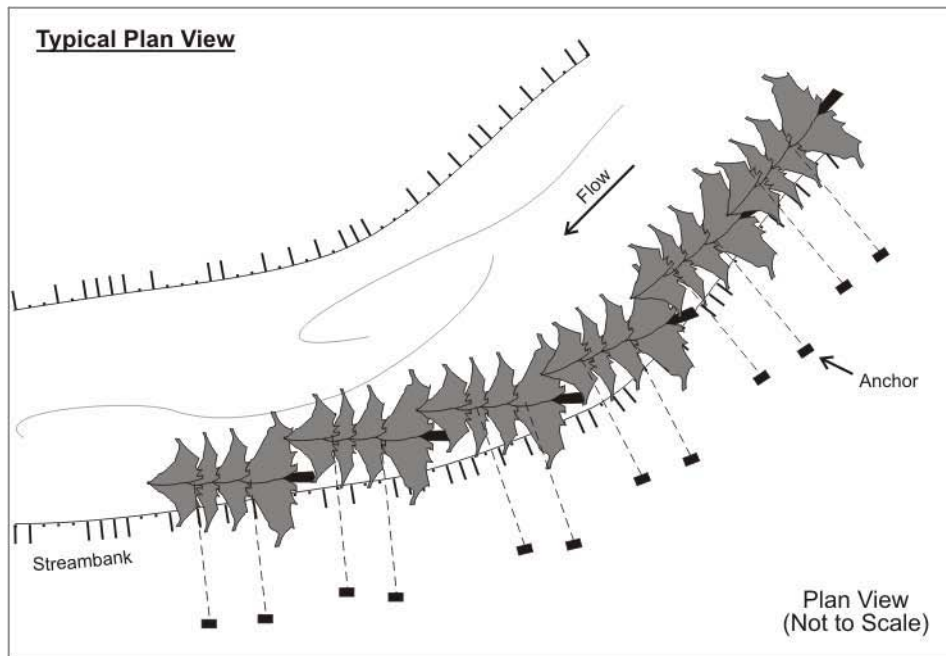

Notes:

1. Proper placement and design are critical and, qualified specialists should be involved.
2. Select only sturdy, straight coniferous trees with adequate branches and a minimum length of 10 m.
3. Do not trim any branches and handle with care. Leave root ball intact, if feasible and transport the trees to the site with a minimum of handling to reduce damage to the branches. To the extent practical, remove soil material from the rootball before placing the tree instream. Place the trees lengthwise along or across the eroding bank to be protected beginning at the downstream end with the tips of the trees pointed in the downstream direction.
4. Begin assembly of the tree revetment at the downstream end and place tie back cable on the tree butt (largest end). Attach the cable to a suitable deadman or large armour rock with a drilled hole. Bury the anchor securely in the adjacent bank.
5. Place the butt of the next tree one-half the length of the previous tree or less upstream along the bank, so there is an overlap of the trees. If feasible, cable the trees together in addition to cabling to an anchor buried in the bank.
6. Rock armour may be added along the toe of the slope, beneath the trees to reinforce the level of protection provided.
7. Maintenance, consisting of replacing severely damaged trees, will extend the life span of the revetment.
8. Coniferous tree revetments also may be used as instream cover.

Adapted from Alaska Department of Fish and Game (1997)

STREAMBANK PROTECTION – TYPICAL CONIFEROUS TREE REVETMENT



canadian
energy
pipeline
association

association
canadienne
de pipelines
d'énergie



Fourth Edition

November 2012

DWG. NO. 24

(A) Gabions Offset to Maintain Bank Slope

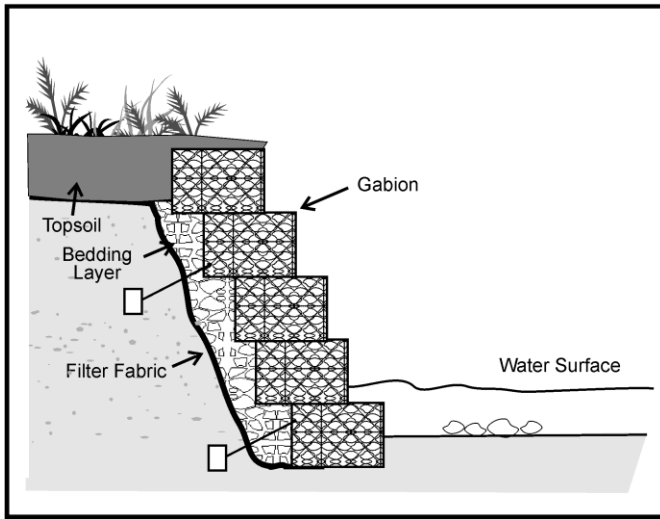

(B) Gabions Installed Flat Against Streambank

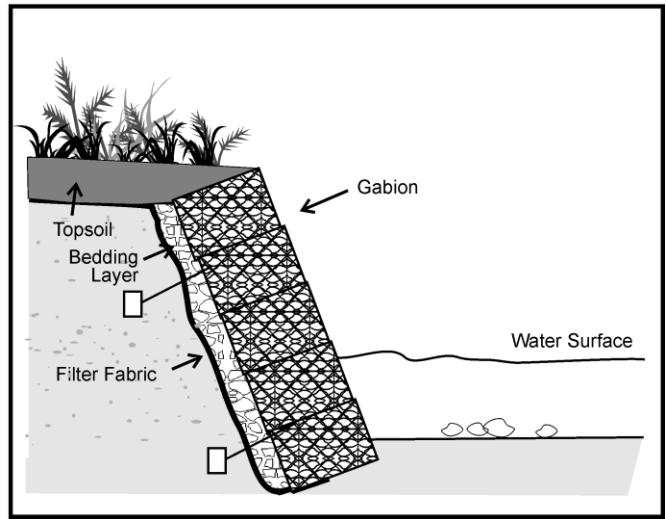

Profile
(Not to Scale)

Notes:

1. Proper placement and design are critical, and qualified specialists should be involved.
2. Gabions can be installed on slopes that exceed 1.5:1. Installation flat to slope is preferred on high banks.
3. Install gabions to a height of about 1 m above high water level.
4. Care should be taken not to restrict the stream channel capacity, particularly on smaller watercourses.
5. Excavate a key trench along the toe of the bank to a point below the anticipated scour depth. Place filter fabric and a bedding layer of coarse gravel on excavated slope as the gabions are installed.
6. Tie gabions together with heavy gauge wire and anchor into the banks at the up and downstream ends.
7. Fill gabion baskets in layers with angular rock larger than the mesh openings. Close and tie down the first row and repeat. Backfill behind baskets and cap with topsoil.

Adapted from Envirowest (1990)

STREAMBANK PROTECTION – TYPICAL GABION BASKETS



canadian energy pipeline association
association canadienne de pipelines d'énergie



Fourth Edition

November 2012

DWG. NO. 25

Preparation

(a) Line Trench With Burlap

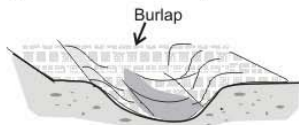

(b) Fill With Grass Clumps



(c) Fold Burlap over Grass Clumps so Clumps are Snug Against each other.



(d) Pull Shoots Through Wrap



Profile
(Not to Scale)

Implementation

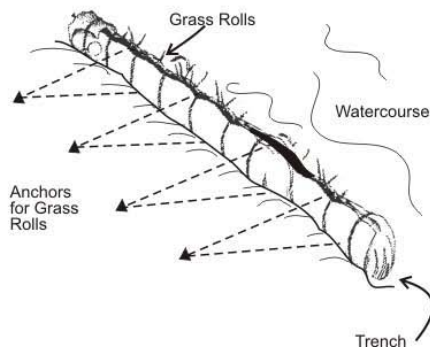
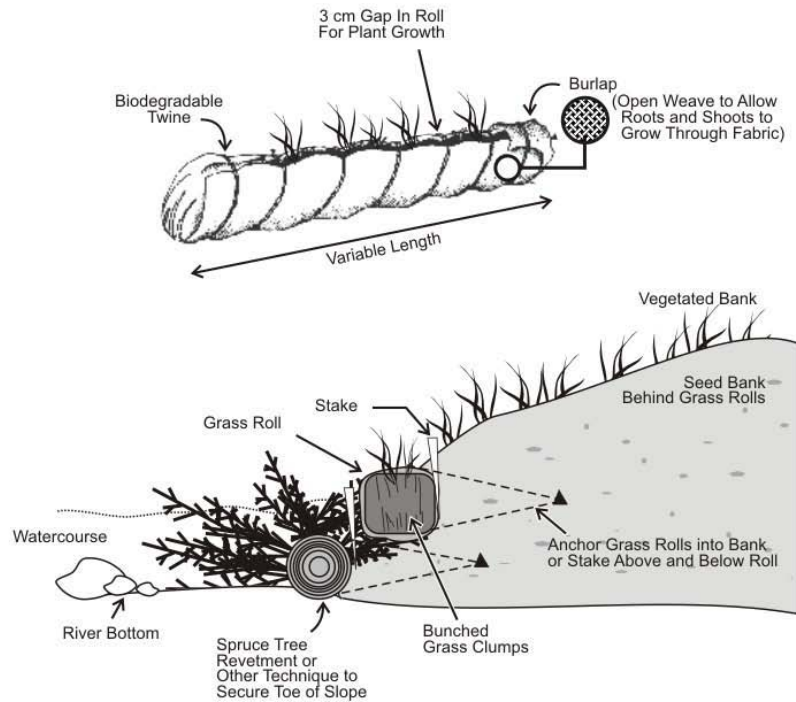

(Not to Scale)

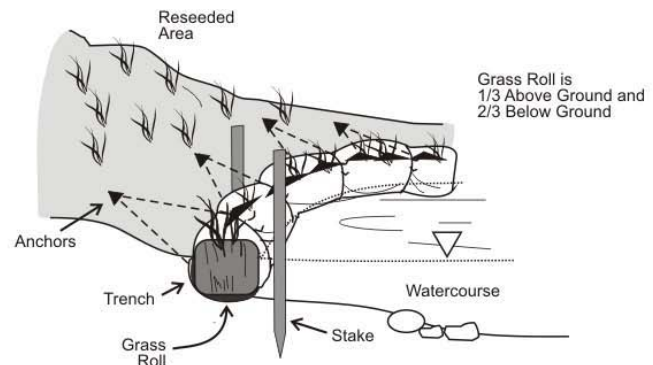

Notes:

1. Proper placement and design are critical, and qualified specialists should be involved.
2. Excavate a shallow trench along the high water mark parallel to the toe of the bank and line with burlap.
3. Install sod in the middle of the roll and wrap with burlap covers. Tie with twine and cut slits to expose sections of sod.
4. Stake or anchor firmly ensuring up and downstream ends are secured to prevent washing out.

Adapted from Alaska Department of Fish and Game (1997)

STREAMBANK PROTECTION – TYPICAL GRASS ROLL



canadian energy pipeline association / association canadienne de pipelines d'énergie



Fourth Edition

November 2012

DWG. NO. 27

Preparation

(a) Line Trench With Burlap

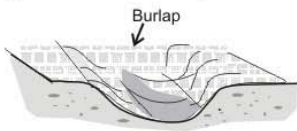

(b) Fill With Grass Clumps



(c) Fold Burlap over Grass Clumps so Clumps are Snug Against each other.



(d) Pull Shoots Through Wrap

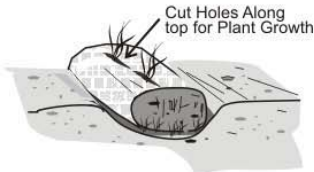

Profile
(Not to Scale)

Implementation

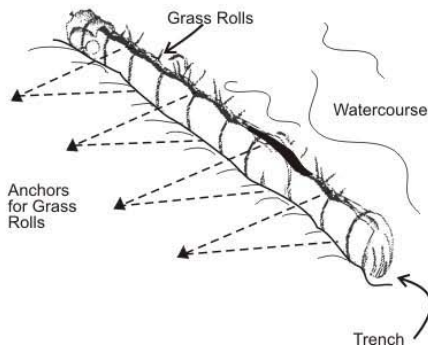
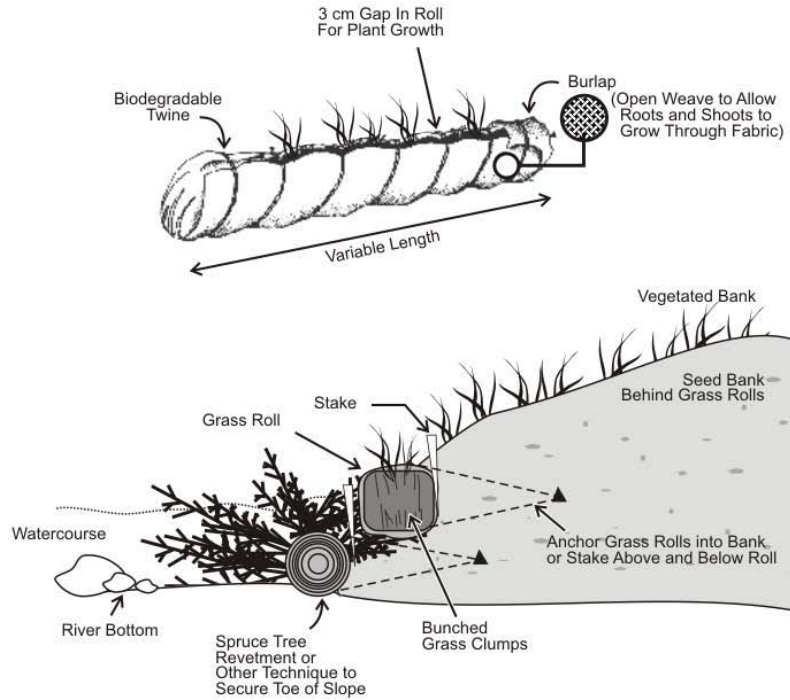

(Not to Scale)

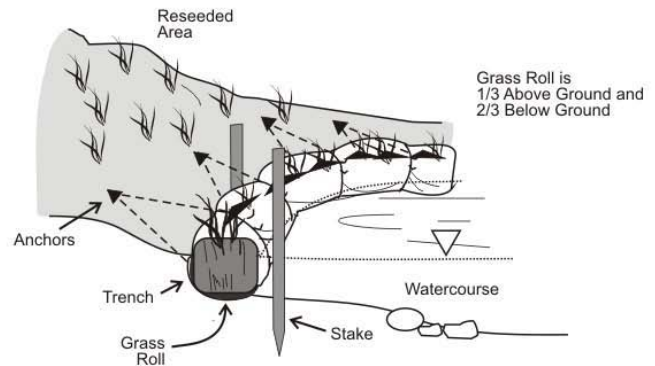

Notes:

1. Proper placement and design are critical, and qualified specialists should be involved.
2. Excavate a shallow trench along the high water mark parallel to the toe of the bank and line with burlap.
3. Install sod in the middle of the roll and wrap with burlap covers. Tie with twine and cut slits to expose sections of sod.
4. Stake or anchor firmly ensuring up and downstream ends are secured to prevent washing out.

Adapted from Alaska Department of Fish and Game (1997)

STREAMBANK PROTECTION – TYPICAL GRASS ROLL



canadian energy pipeline association / association canadienne de pipelines de l'énergie



Fourth Edition

November 2012

DWG. NO. 27

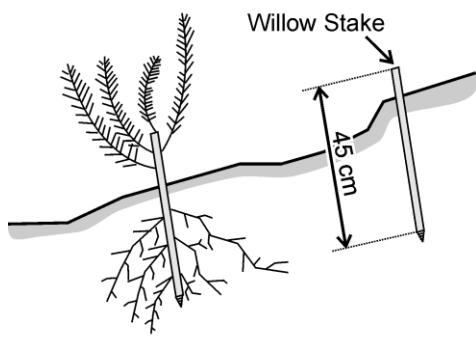

Profile
(Not to Scale)

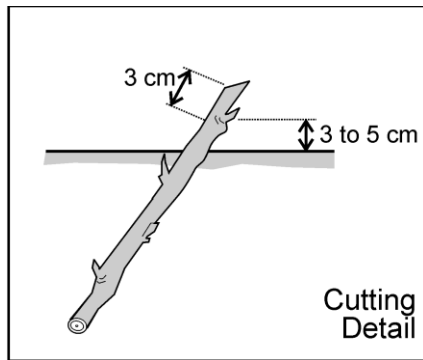

Profile
(Not to Scale)

Staking Pattern Detail

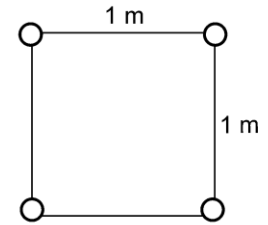

Plan View
(Not to Scale)

Notes:

1. Install stakes of suitable species (e.g. willow, dogwood) on watercourse banks.
2. Make clean cuts with unsplit ends using pruning shears, hand saw or chain saw.
3. Select stock from bottom of branches not tips.
4. Mark basal ends to ensure correct installation.
5. Ensure at least one lateral bud above surface and three below. Plant cutting at an angle.
6. Protect material from drying out. Install as quickly as practical.
7. Trim side shoots close to main stock.
8. Use frost pin to make pilot hole. Minimize damage to stake when driving by using a neoprene lined post hole pounder or rubber mallet.
9. Install live stakes on banks and 1.5 m (approximately) back from banks for entire disturbed width of right-of-way.

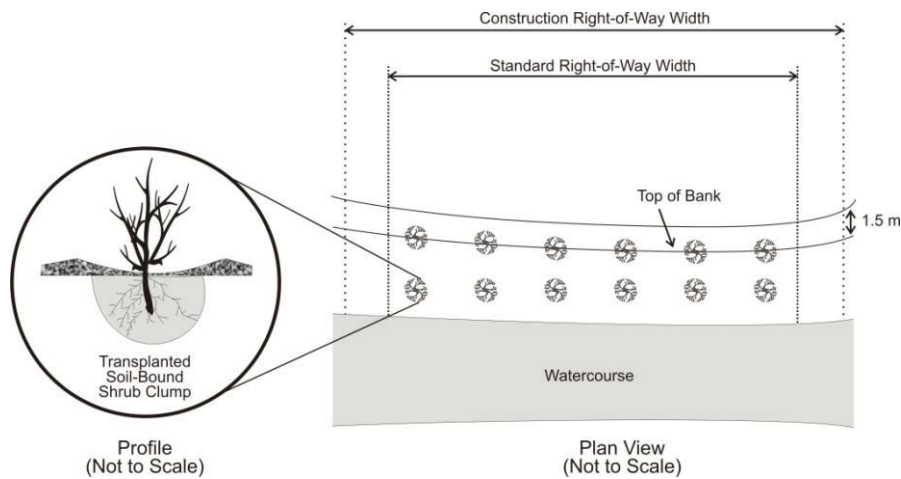

Profile
(Not to Scale)

Plan View
(Not to Scale)

Notes:

1. Salvage and replace shrubs on all watercourse banks where shrubs are present on the right-of-way.
2. Salvage whole bushes from the right-of-way during grading of banks. Ensure bulk of root mass is surrounded by soil.
3. Store salvaged shrubs on edge of right-of-way, cover with soil and do not let dry out.
4. Transplant as quickly as practical when reconstructing watercourse banks.
5. Soak the ground around the transplant with water.

Adapted from CAPP *et al.*(2005)

STREAMBANK PROTECTION – TYPICAL SHRUB RESTORATION



canadian energy pipeline association / association canadienne de pipelines d'énergie



Fourth Edition

November 2012

DWG. NO. 28

A. Overhanging Banks - Crib Wall

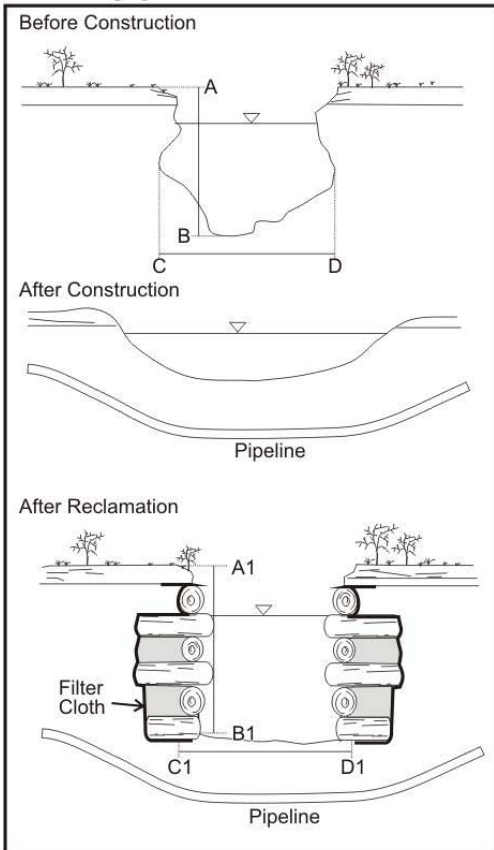

B. Vertical Banks - Log Wall

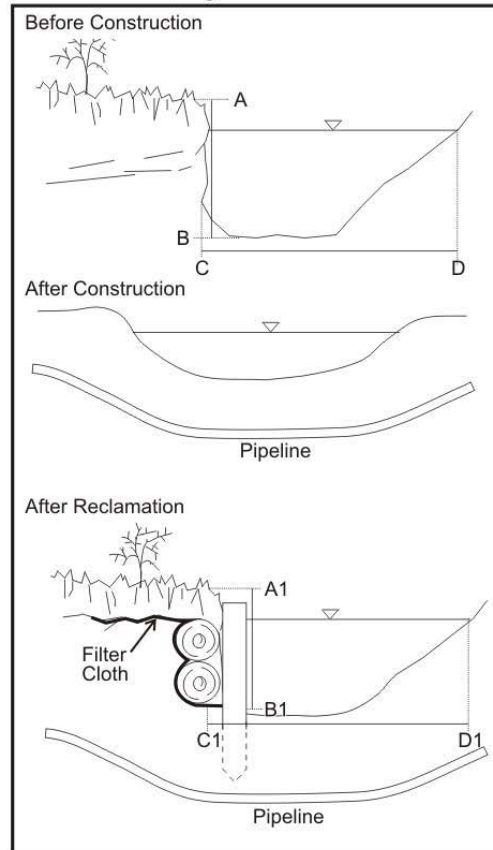

Profile View
(Not to Scale)

Notes - Overhanging Bank Cribwalls:

1. Proper placement and design are critical, and qualified specialists should be involved.
2. Install overhanging bank cribwalls to provide overhead cover and erosion control.
3. Install the log overhang greater than 30 cm.
4. Install native timber (coniferous where possible).
5. Compare crossing with adjacent undisturbed up and downstream locations to ensure A1-B1 is not less than A-B.
6. Compare crossing with adjacent undisturbed up and downstream locations to ensure C1-D1 is not greater than C-D.
7. Backfill with coarse, nonerodible material.
8. Replace subsoil and topsoil.
9. Transplant native vegetation and sow appropriate seed mix.
10. Live willows may be laid perpendicularly to streamflow within and projecting from the cribwall above the water line. This will create a live cribwall.

Notes - Vertical Bank Logwalls:

1. Proper placement and design are critical, and qualified specialists should be involved.
2. Install bank log walls to maintain bank slope and provide erosion control.
3. Install pressure treated vertical posts three times length of exposed height.
4. Utilize native timber or lumber for horizontal structure.
5. Compare crossing with adjacent undisturbed up and downstream locations to ensure A1-B1 is not less than A-B.
6. Compare crossing with adjacent undisturbed up and downstream locations to ensure C1-D1 is not greater than C-D.
7. Anchor posts if warranted.
8. Backfill with coarse nonerodible material.
9. Replace subsoil and topsoil.
10. Transplant native vegetation. Sow approved seed mix.
11. Live willows may be laid perpendicularly to streamflow within and projecting from the logwall above the water line. This will create a live logwall.

Adapted from CAPP *et al.* (2005)

STREAMBANK PROTECTION – TYPICAL LOG AND CRIB WALLS



canadian
energy
pipeline
association

association
canadienne
de pipelines
d'énergie



Fourth Edition

November 2012

DWG. NO. 29

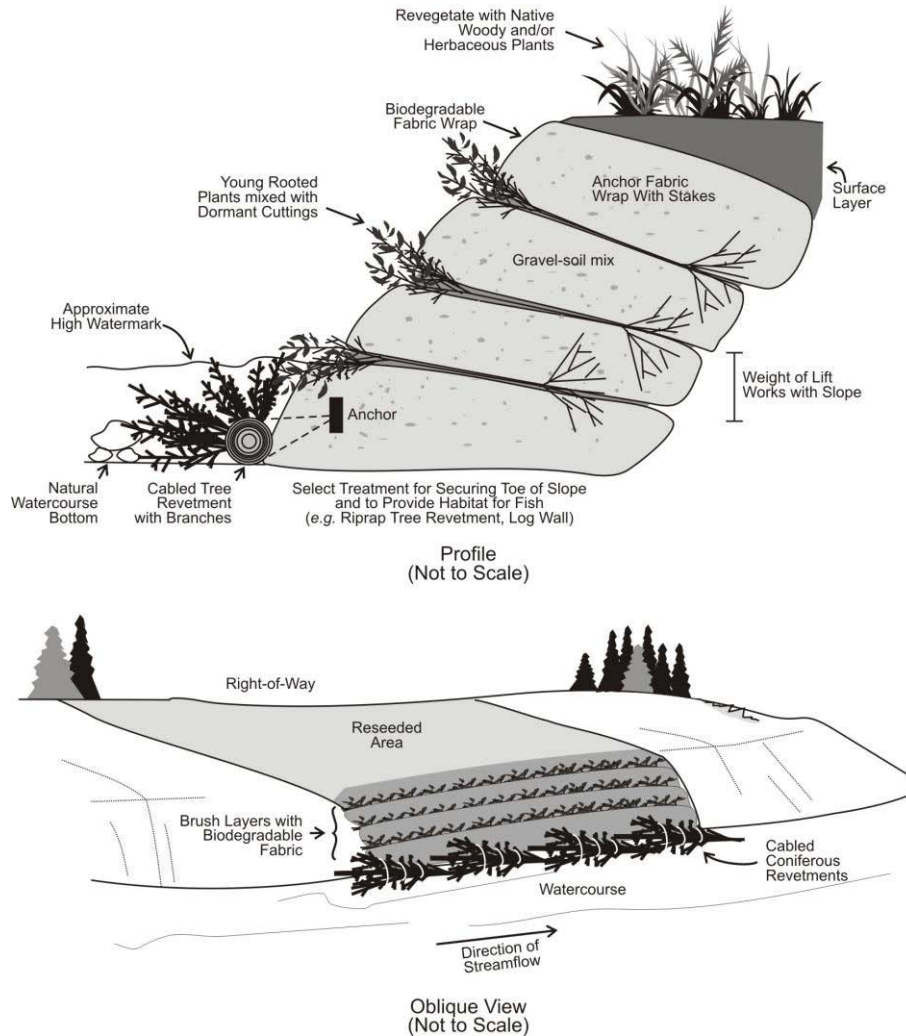

Notes:

1. Proper placement and design are critical, and qualified specialists should be involved.
2. Secure the toe of the slope with the appropriate technique (coniferous tree revetments, log wall, riprap, etc.).
3. Begin layering at the bottom of slope with the first hedge/brush layer situated at the approximate high water mark or lower. Select plant species suitable for site conditions.
4. Excavate the first bench 0.5-1.0 m deep, angled slightly down into the slope. To make each layer, roll out the biodegradable fabric (e.g., coir or equivalent) parallel with the bank with one-third into the bank and two-thirds on the watercourse side. On top of the fabric, lay locally salvaged branches and transplants (at 18-25 stems per metre), slightly criss-crossing, with shoots extending beyond the edge of the bench by approximately 20% of their length. Use higher densities of stems for more erosive sites or if the cutting's diameter is small. Cover with 5-10cm of soil and tamp into place.
5. Form a step of soil 30-40 cm high over the bank side fabric. Fold the watercourse side fabric over the soil step and firm into place.
6. Continue building layers with damp soil and cuttings until the preconstruction bank height is reached. Vary spacing between layers based on erosion potential.
7. For best results collect transplants during plant dormancy or in the spring or late summer. Keep collected plant material moist and, if practical, plant the same day. A mixture of plant species can mimic adjacent undisturbed vegetation.

Adapted from Alaska Department of Fish and Game (1997)

STREAMBANK PROTECTION – TYPICAL HEDGE/BRUSH LAYERING



canadian
energy
pipeline
association

association
canadienne
de pipelines
d'énergie



Fourth Edition

November 2012

DWG. NO. 30

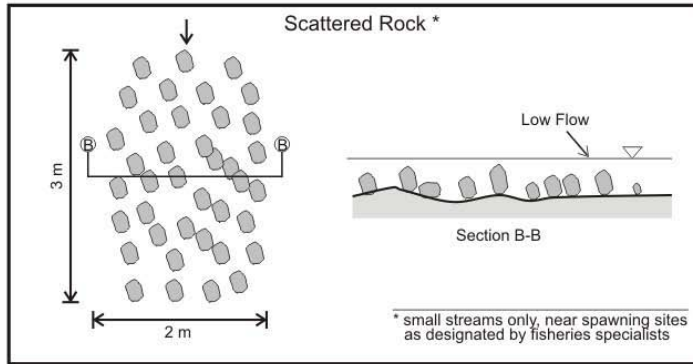
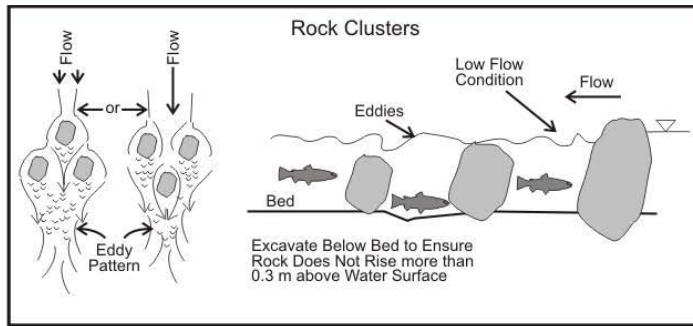
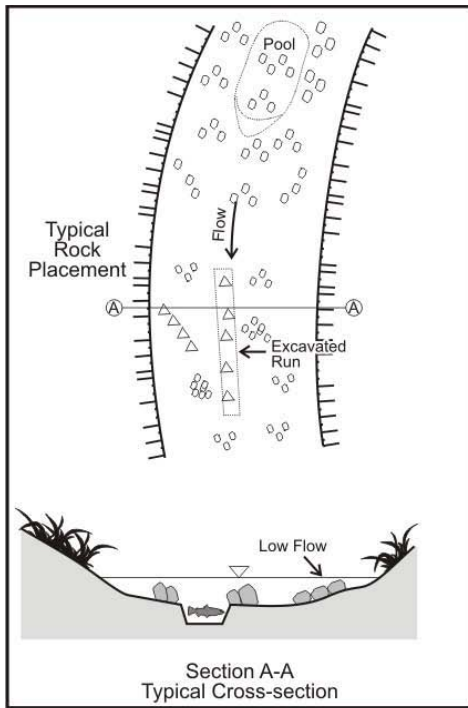

(Not to Scale)

Notes:

Rock Clusters (adult shelter):

1. Proper placement and design are critical, and qualified specialists should be involved.
2. Navigable Waters approval may be required prior to installing rock clusters.
3. Individual rocks may be in clusters of two to five (generally three), placed in various patterns as shown or as directed in the field. Place rocks in the middle 3/4 of the watercourse such that they do not direct current against an existing unprotected bank.
4. Pre-excavate holes so that the rocks are at or below, but not to exceed 0.3 m above existing water level at the time of installation.
5. Arrange the rocks within clusters, averaging 0.8-1.5 m apart, with a minimum space of 2.5 m between each of the clusters.
6. Individual rocks or rock clusters may be placed within a resting pool, excavated run or natural pool or run to enhance shelter and feeding opportunities.
7. For small watercourses, use only small material (0.2-0.4 m) for normal rock clusters. Placement will depend upon flow velocities, depths and location of riffles and pools.
8. For mid size watercourses, large individual rocks are preferred (0.8-1.2 m).

9. For large watercourses (width 50 m), individual rocks in the range of 2.0-3.0 m in diameter are recommended. Exact placement of these rocks is critical to avoid encouraging bank erosion and specialist advice should be obtained.
10. All rock used must be angular, hard, durable and preferably (not necessarily) weathered for visual acceptance.

Scattered Rock (Fry Shelter):

1. Proper placement and design are critical, and qualified specialists should be involved.
2. Navigable Waters approval may be required prior to installing rock clusters.
3. All rock to be 300 mm or less in diameter, placed in shallow fast moving flow areas such that the top of the rock is at/below normal low water levels.
4. The rock fragment grouping is very loose with an overall size of 2 m x 2 m with individual pieces of rock 0.3 m apart.
5. Place scattered rock groups approximately 2.0 m apart, preferably in shallow water near banks to benefit young-of-year and maintain open flow areas.

Adapted from CAPP 1993

INSTREAM COVER – TYPICAL ROCK CLUSTERS



canadian energy pipeline association / association canadienne de pipelines d'énergie



Fourth Edition

November 2012

DWG. NO. 31

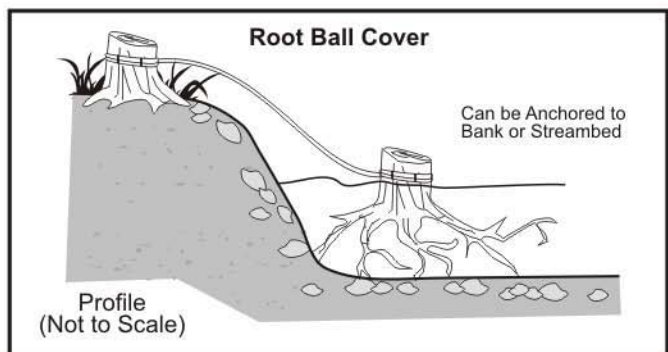
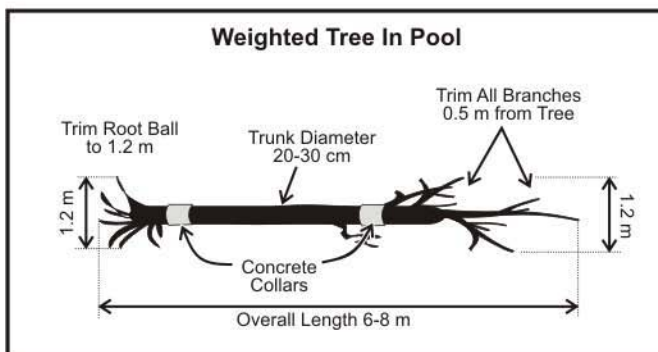
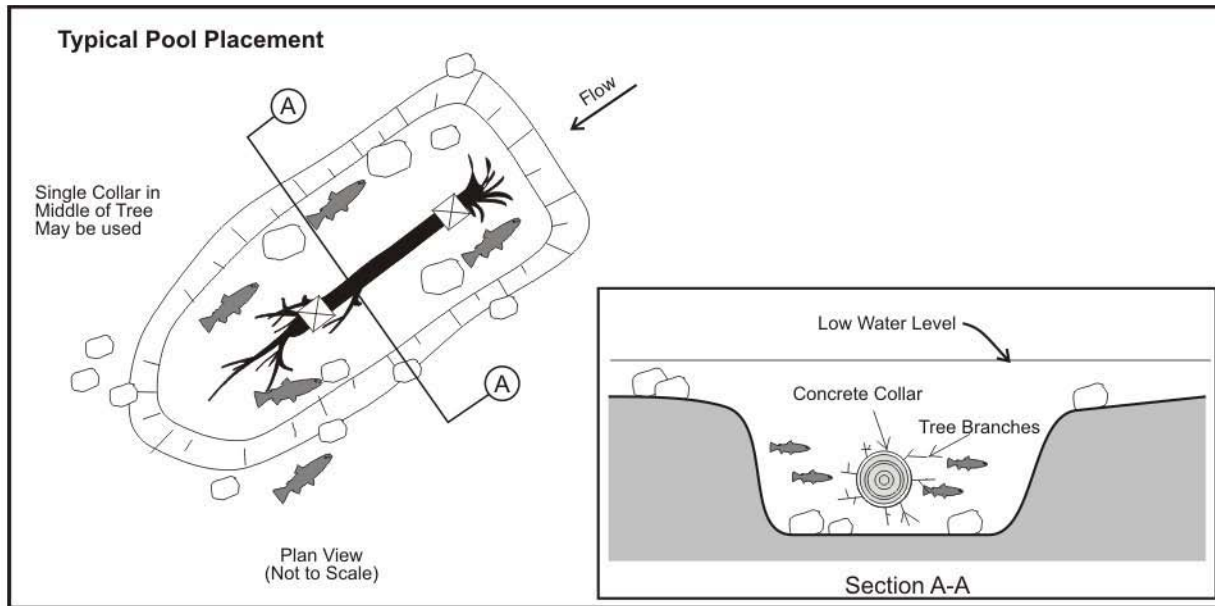

Notes:

Weighted Tree in Pool:

1. Proper placement and design are critical, and qualified specialists should be involved.
2. Navigable Waters approval may be required prior to installing log or root balls.
3. Use only sturdy, straight coniferous trees with adequate branches and root ball, 6-8 m in length, with a minimum diameter of 0.4 m.
4. Trim the root ball and all branches so that they remain 0.6 m below the surface of the pool and will not snag any boat traffic or debris.
5. Place 50+ kg concrete pipe weights on each end of the tree, where the trunk will support the heavy weights and move the tree into the pool area utilizing two backhoes, if feasible. Carefully lower the tree to the bottom of the upstream end of the pool (breakage may occur due to heavy pipe weights).
6. Place rock clusters in and around the pool if desired.
7. Weighted trees may be added to or removed from pools at any time after construction to change shelter provisions.

Root Ball Cover:

1. Proper placement and design are critical, and qualified specialists should be involved.
2. Navigable Waters approval may be required prior to installing log or root balls.
3. Select and clean large coniferous root balls.
4. Trim and anchor the root balls securely to the bank or streambed so that they remain 0.6 m below the water surface.

Adapted from CAPP 1993

INSTREAM COVER – TYPICAL LOG/ROOT BALLS



canadian
energy
pipeline
association

association
canadienne
de pipelines
d'énergie



Fourth Edition

November 2012

DWG. NO. 32

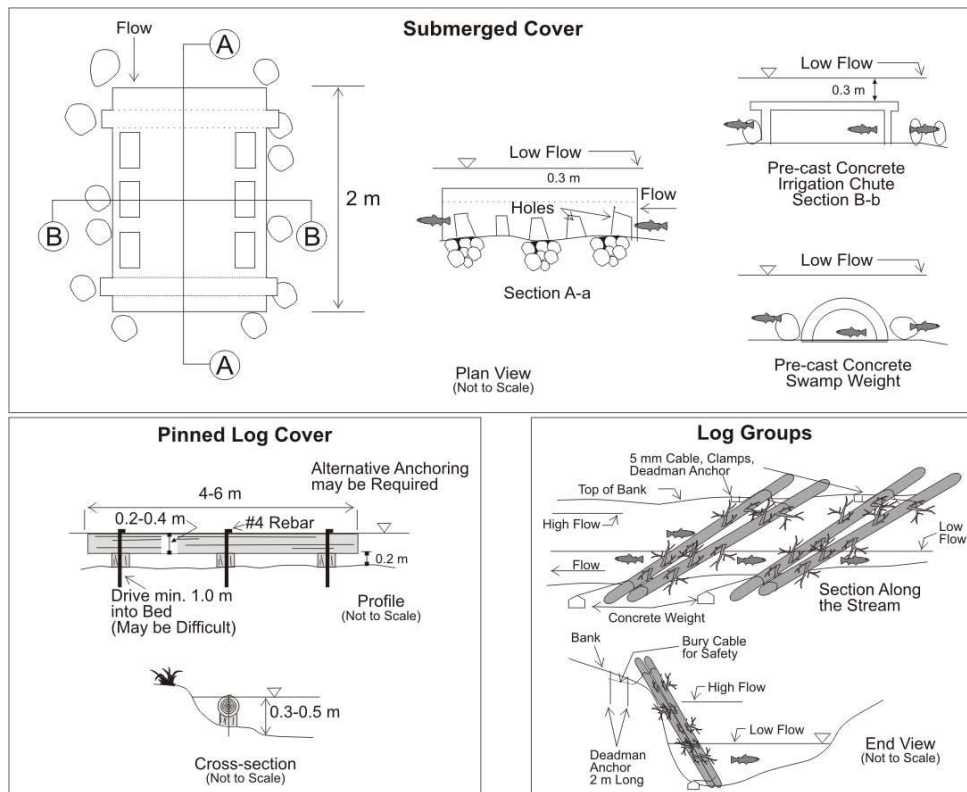

Notes:

Submerged Cover

1. Proper placement and design are critical, and qualified specialists should be involved.
2. Navigable waters approval may be required prior to installing a submerged cover.
3. Prior to installation, punch several holes in the upper area of the concrete pipe to allow numerous shelter/water interfaces and visual access to the inside of the half pipe.
4. Concrete sections may be set together or placed individually on 2 m triangular steel bars to reduce the amount of settlement into the instream gravels.
5. Place the pre-cast section in the lowest point of the watercourse, parallel to the direction of flow so there will be smooth flow conditions through the pipe section. Water depth at low flow should equal or exceed the structure height.

Pinned Log Cover

1. Proper placement and design are critical, and qualified specialists should be involved.
2. Select sound coniferous trees and remove all limbs within 0.2 m from the trunk of the tree and transport to the site.
3. Cut three small logs (0.3 m long) from the tree and drill lengthwise to accept 3/4" reinforcing steel rod. Drill three similar holes in the tree to accept the steel rods as shown in the drawing.
4. Select a location, 0.3-0.5 m depth. Place the rebar through main log, and support logs and drive rebar a minimum of 1.0 m into the streambed for good anchorage. Bend the top section of the rebar as shown to anchor the log to the streambed. Additional rebar may be warranted. An alternate anchoring system may be necessary if unable to drive the reinforcing steel into the streambed.

Log Groups

1. Proper placement and design are critical, and qualified specialists should be involved.
2. Select sound straight coniferous trees, remove tree limbs 0.3 m from the trunk and transport to the site.
3. Select 2-3 trees and tie into a loose bundle. Overlap the tree lengths by at least 1/2 their length or more.
4. Cable log tips to a 20 kg (or more) concrete weight, which will be placed on the streambed to hold the tips in place.
5. Anchor the base of the logs on the bank with a 5 mm tieback cable to several deadman anchors to prevent movement. Bury the cable tieback to avoid safety hazard to fishermen.
6. Log groups can also be placed with rock clusters by using a short log deadman anchor buried beneath a large rock (1.5 m+) in the middle of the streambed. The log groups are oriented in the downstream direction.

Adapted from CAPP 1993

INSTREAM COVER – TYPICAL SUBMERGED COVER



canadian energy pipeline association / association canadienne de pipelines d'énergie



Fourth Edition

November 2012

DWG. NO. 33

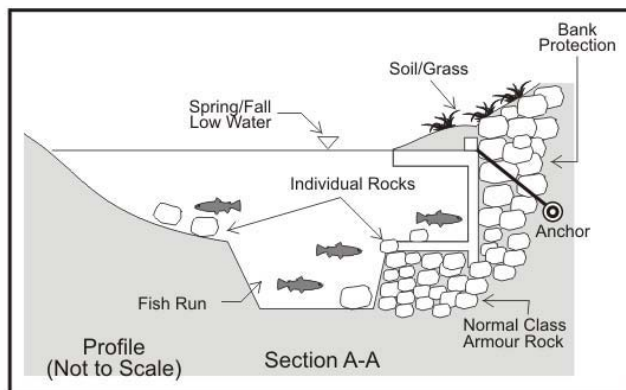
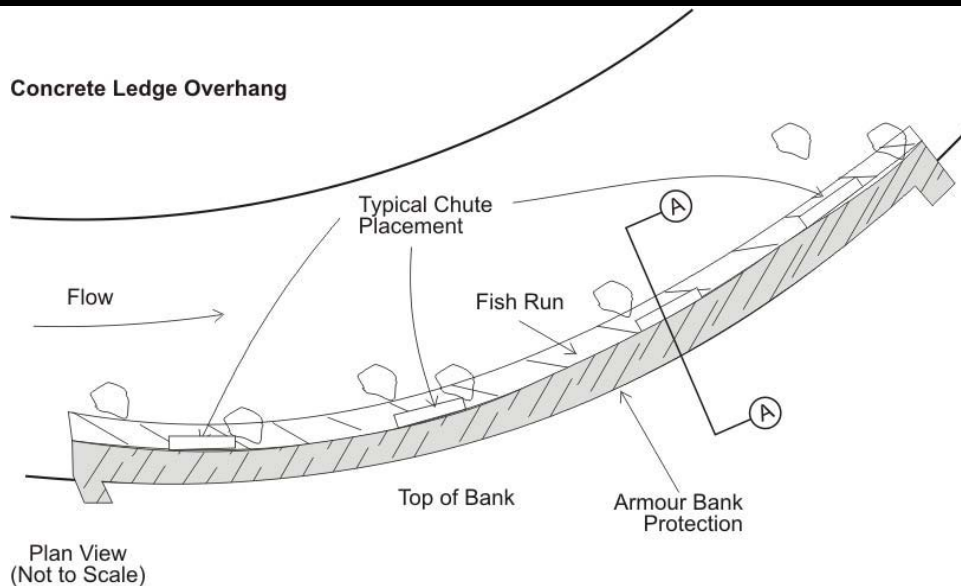

Notes:

1. Navigable Waters approval may be required prior to installing bank overhang.
2. Proper placement and design are critical, and qualified specialists should be involved.
3. If the concrete ledge section is added before bank armour rock installation is complete, place only the lower portion of rock upon which concrete chute sections will rest. Install all necessary tiebacks, anchors and individual rocks within the flume, taking great care that the flume sections line up horizontally and are well supported.
4. If the flume section is added to an existing armour rock bank, limit the disturbance of the armour rock, removing only enough rock to set the flume sections firmly in place. Install the needed tiebacks, anchors and individual rocks within the flume, ensuring the flume sections line up horizontally.
5. Replace the armour rock around the back and ends of the chute, ensuring that no change in horizontal alignment takes place.
6. Backfill the top of the structure with light armour rock. Add soil grass and trees where feasible on or near the embankment.
7. This structure may be placed at any location whether there is existing bank protection or not. The method of construction will limit the disturbance of the armour rock.
8. Maintenance may be necessary to maintain proper horizontal alignment of the sections to avoid damage occurring to the structure when a strong current catches an edge separation.

Adapted from CAPP 1993

INSTREAM COVER – TYPICAL BANK OVERHANG



canadian
energy
pipeline
association

association
canadienne
de pipelines
d'énergie



Fourth Edition

November 2012

DWG. NO. 34

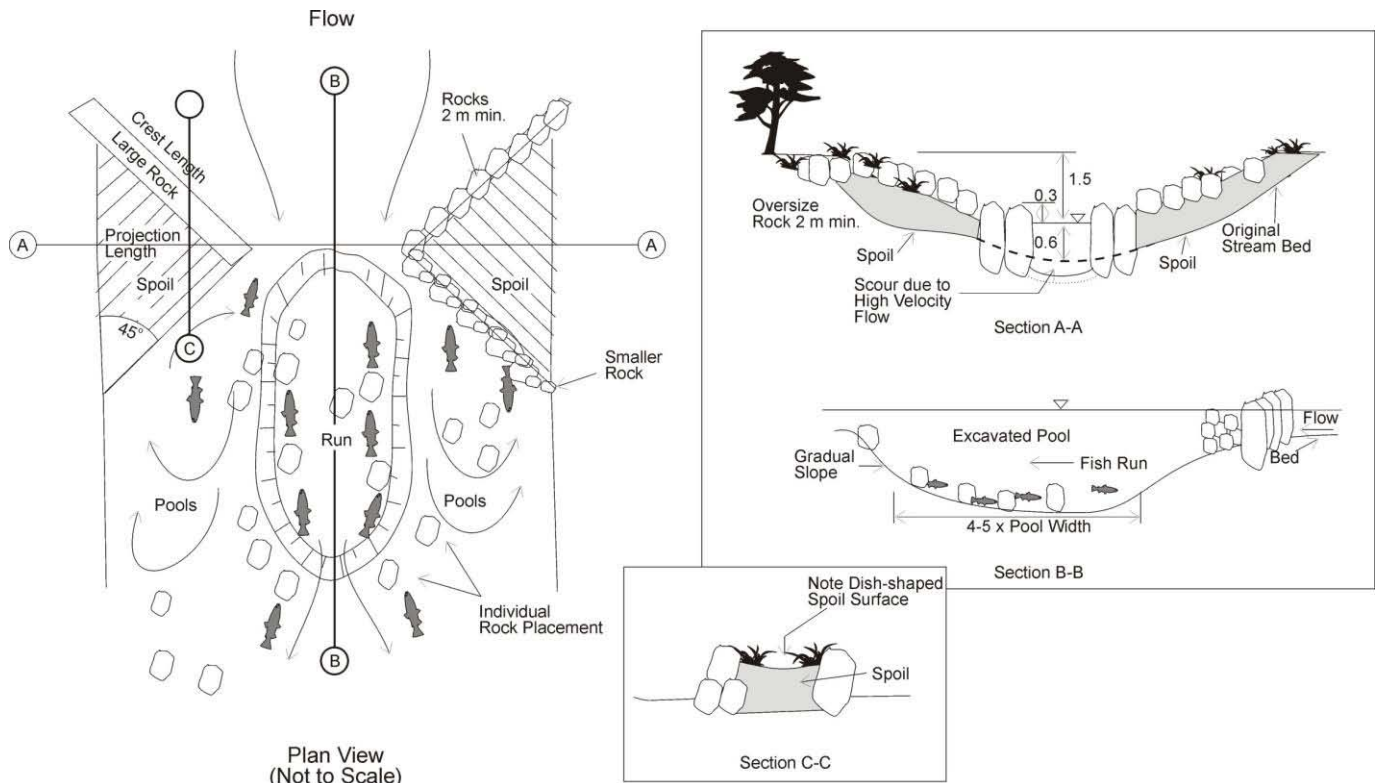

Notes:

1. Navigable Waters approval may be required prior to installing opposing rock wing deflectors.
2. Proper placement and design are critical, and qualified specialists should be involved.
3. All rocks must slope down to the middle of the watercourse to the point of the deflector.
4. The upstream face must contain the largest rocks so that the pressure of the flow may be resisted. Smaller rocks may be placed on the downstream face. Each rock is to be placed in the shadow of the previous rock from the point to the bank. All rock must fit tightly together and be jammed together by machinery.
5. Place the upstream rock face in a trench, then place the downstream rock face in a similar trench, taking care that the rocks slope upwards to the side of the watercourse such that the point of the deflector is about 0.3 m above the water level and the root is at least 1 to 1.5 m above current water level. Ensure that excavation work is conducted in accordance with ground disturbance requirements.
6. Excavate the downstream run, placing much of the spoil material within the confines of the two rock faces. The top surface of the spoil must be below the level of the adjacent rock faces. All remaining spoil must be deposited 10 m outside the streambanks and preferably 1.5 m above the water level.
7. In very large watercourses, a double row of rocks will be needed for both the up and downstream faces of the deflectors.
8. The open area in the middle of the watercourse must be about 1/4 of the watercourse width or less, so that a section of the rapid flow conditions exists to funnel the water into the downstream run. On occasion the opening must be constricted even more to provide higher flow velocities when necessary.
9. The instream point of the deflectors shall be 0.6 m above the streambed. Ensure that the root of the deflectors is 1.0 to 1.5 m above current water levels and firmly imbedded in the streambank.
10. All elevations relate to low streamflow in the spring or fall.

Adapted from CAPP 1993

CURRENT DEFLECTORS – TYPICAL OPPOSING ROCK WING DEFLECTORS



canadian energy pipeline association / association canadienne de pipelines d'énergie



Fourth Edition

November 2012

DWG. NO. 35

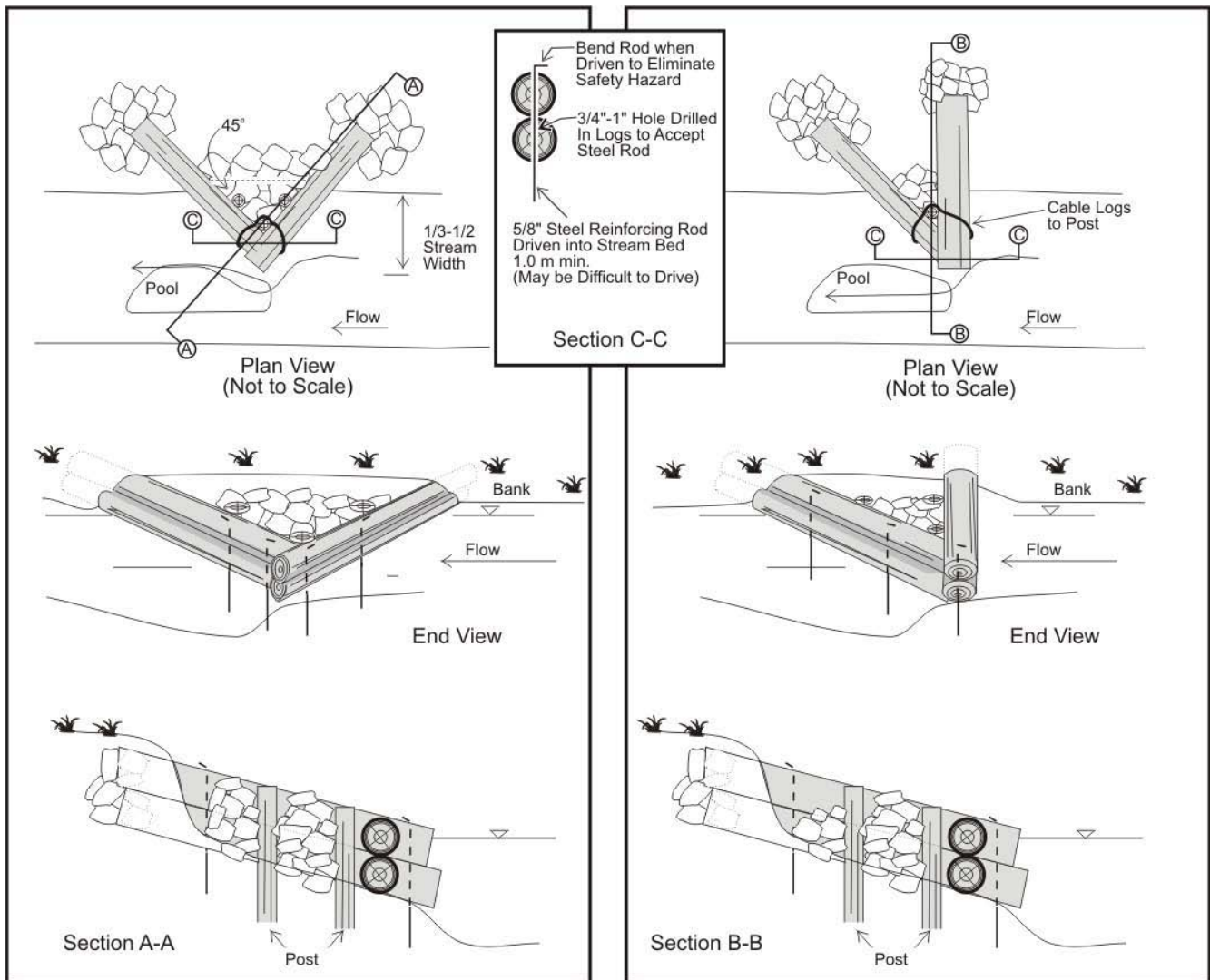

Notes:

1. Navigable Waters approval may be required prior to installing a log deflector.
2. Proper placement and design are critical, and qualified specialists should be involved.
3. Select sturdy, straight coniferous trees; trim all branches; debark all logs and transport to the site. Cut logs to the required length.
4. Set the main deflector logs into a pre-excavated trench in the streambed. The base of the logs must be on the bank and the points of the deflector on the streambed. Where only smaller logs are available, one log is set on top of another and pinned together for support and correct alignment. A 15 cm (minimum) diameter post is to be driven deeply into the streambed at the inside point of the deflector logs for additional support. The logs may also be pinned to the streambed with reinforcing steel.
5. The deflector logs must extend from a low point in the watercourse (about 1/3 to 1/2 the watercourse width) up and into the banks a distance of 1.5-2 m. Additional logs are to be placed on top of the initial logs if necessary and pinned to the bottom log and cabled to the post for additional support.
6. Place large rocks around and against the base of the deflector logs, and on the inside point to hold them firmly in place.
7. The top of the log deflector shall not be more than 0.6 m above the streambed, unless a more effective deflector is required.

Adapted from CAPP 1993

CURRENT DEFLECTORS – TYPICAL LOG DEFLECTOR (Small Watercourses, Width <5 m)



canadian energy pipeline association / association canadienne de pipelines d'énergie



Fourth Edition

November 2012

DWG. NO. 36

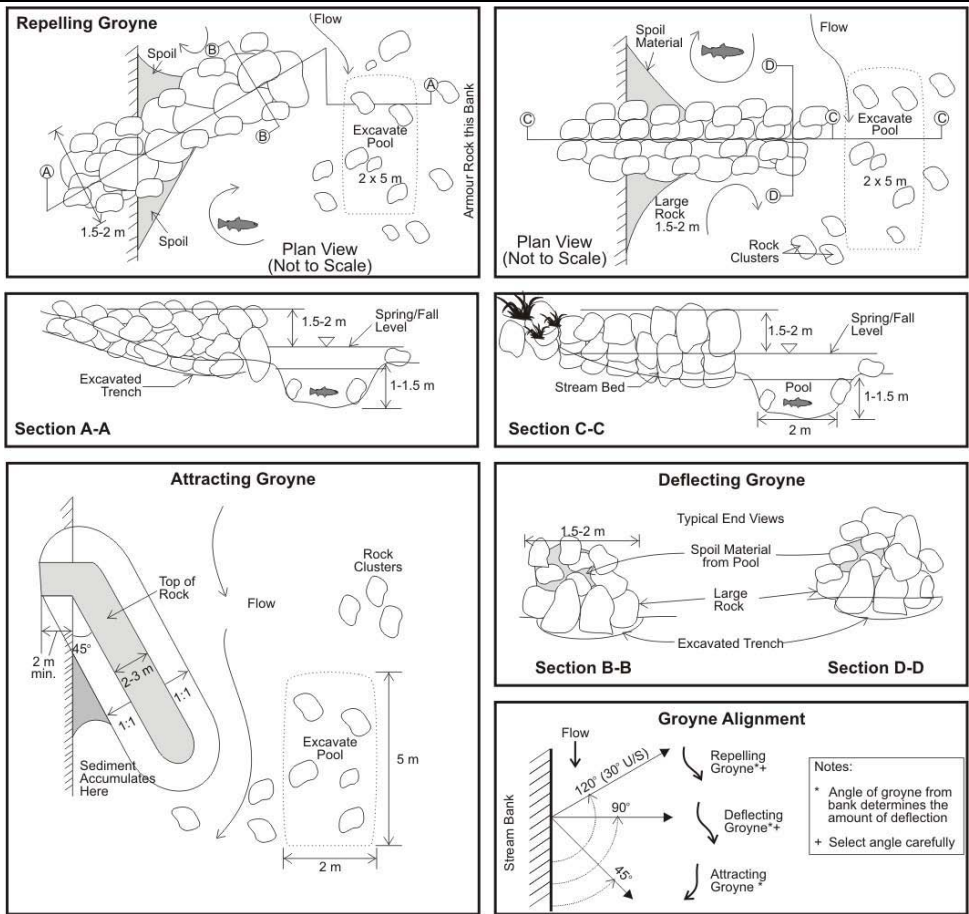

Notes:

1. Navigable Waters approval may be required prior to installing a groyne.
2. Proper placement and design are critical, and qualified specialists should be involved.
3. The largest rocks are always to be placed at the tip of the groyne.
4. Projecting length must not exceed 1/2 the watercourse width.
5. Groynes are always to be countersunk into the bank.
6. Only a small amount of spoil material is to be placed on the groyne to fill holes and soften appearance. All remaining spoil material is to be placed 10 m outside the channel.

Repelling Groynes - 30° upstream

1. Deflects the main current toward the opposite bank. Heavy armour bank protection is required on the opposite bank.
2. This structure will protect a length of eroding bank up to 3.5 times the projecting length. They are normally utilized to deflect flows away from an eroding bank under severe erosion conditions, large flows or unstable banks.

Deflecting Groynes - 90° to the bank

1. Deflects the current from along the bank into mid-stream away from the groyne. The opposite bank requires protection when the projection length approaches 1/2 the watercourse width. These are used to provide economical channel narrowing in wide shallow reaches.
2. Typical design is a series of groynes, each 3 m long at 10 m spacing around the outside bend of a watercourse, with a small pool at the tip of each groyne. Excavated material from fish runs must be properly spoiled or placed on the bank between groynes.

Attracting Groyne - 45° downstream

1. Deflects flow slightly, pulling it downstream behind the groyne.
2. These are normally used to confine rapid, shallow flow to the middle 1/2 of a watercourse or installed on alternating banks to provide a deeper meandering channel pattern in a straight reach when combined with a large Excavated Run and Rock Clusters.

Adapted from CAPP 1993

CURRENT DEFLECTORS – TYPICAL GROYNES – FULL SIZE



canadian energy pipeline association / association canadienne de pipelines d'énergie



Fourth Edition

November 2012

DWG. NO. 37

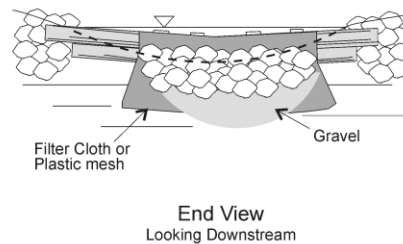
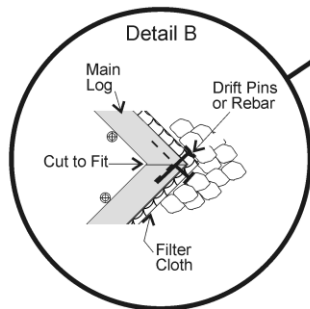
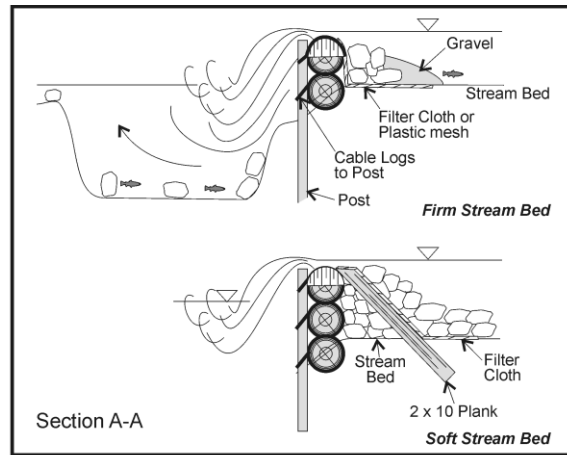
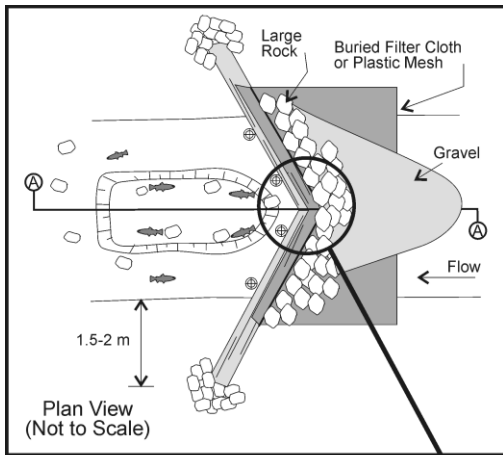

Notes:

1. Navigable Waters approval may be required prior to the installation of a Log V Weir.
2. Proper placement and design are critical, and qualified specialists should be involved.
3. Select sturdy, straight coniferous trees for all main and support logs, trim all branches, debark all logs and transport to the site.
4. Main support logs to be are set into a pre-excavated trench (avoiding the pipeline) in the streambed and must slope down to the middle of the weir to confine the flow to the middle of the watercourse. Where the selected logs are small in size, two layers are required. Set one layer on top of the bottom layer and pin together as needed for stability. Four to six, 15 cm diameter posts are to be driven deeply into the streambed on the downstream side of the weir crest for additional stability. Two posts are to be located near the notch while the others are spaced out along the weir crest. The posts are to be tightly cabled and pinned to the main logs for additional support.
5. The main support logs must extend upstream against the direction of flow from the banks to the middle point of the weir. Bury the logs in the banks for a distance of 1.5-2 m.
6. The central logs are to be pinned together with drift pins through one log into the opposite log. Posts are to be pinned to the main logs.

Adapted from CAPP (1993)

7. Approved filter cloth is to be attached to the upstream side of the main logs and extended down to the streambed. Extended the filter cloth upstream at least 2 m. This filter cloth will prevent the migration of cobbles beneath the log structure. This migration of cobbles is to be avoided at all costs since it eliminates the effectiveness of the structure. Repairs will center on this area.
8. Place large rocks (0.5 m) on the filter cloth against the main logs to keep the filter cloth and logs in place. Smaller material (cobbles) is to be placed on and upstream of the rocks to provide a smooth upstream bed surface and fill in the voids.
9. An alternative is to place short (0.75 m) pieces of 2" x 10" planking extending from the weir crest upstream and down into the channel bed to form a barrier to movement of material similar to the cloth described above. It is recommended to also add the filter cloth. The space under the planking is to be filled with rock and cobbles to eliminate any voids.
10. The upstream notch on the weir must be within the middle third of the watercourse, but may be placed at any point within to move the current from side to side. Bank armoring may be needed in such cases.
11. The top of the log sill at the notch of the weir is not to be more than 0.6 m above the streambed, unless a deeper upstream pool is required. Locate the bank tie-in 1.0+ m above the watercourse elevation or 0.5 m above the notch. Ensure that logs shall taper gradually from the notch to the tie-in point on the bank.

OVERPOUR STRUCTURES – TYPICAL LOG V WEIR (Small Watercourses, Width <5 m)



canadian energy pipeline association / association canadienne de pipelines d'énergie



Fourth Edition

November 2012

DWG. NO. 38

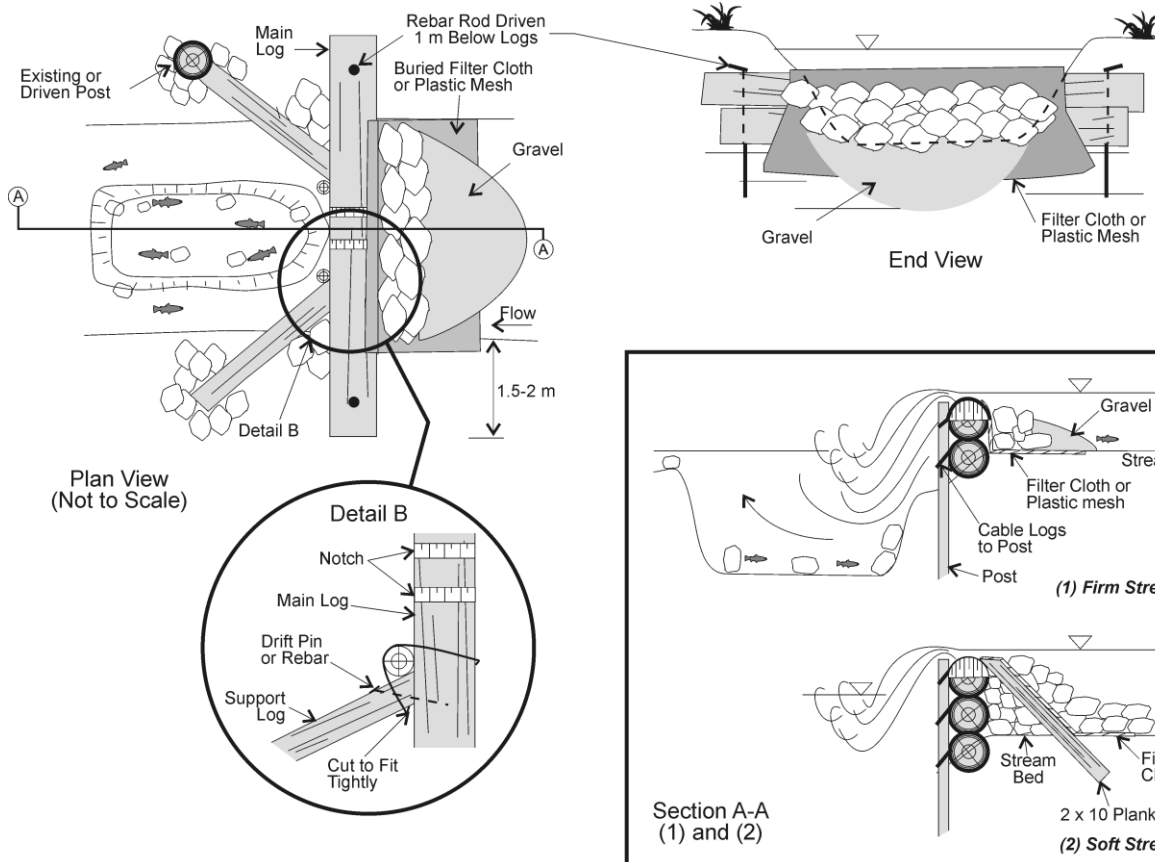

Notes:

1. Navigable Waters approval may be required prior to the installation of a Log K Dam.
2. Proper placement and design are critical, and qualified specialists should be involved.
3. Select sturdy, straight coniferous trees for all main and support logs, trim all branches, debark all logs and transport to the site.
4. Set the main support logs horizontally into a pre-excavated trench in the streambed. Where only small logs are available, one log is to be set on top of another and pinned together for support and correct alignment. The 15 cm diameter posts are to be driven deeply into the streambed on the downstream side of the weir crest for additional stability. The posts are to be tightly cabled to the main logs for support.
5. The main weir crest log must extend across the watercourse and into the banks a distance of 1.5-2 m. Additional logs are to be placed on top and pinned to the bottom log and cabled to the posts.
6. The support logs are to be pinned to the main log with long nails.

Adapted from CAPP (1993)

7. Attach approved filter cloth to the upstream side of the main log and extended down to the streambed. The filter cloth is then to be extended upstream at least 2 m. This filter cloth will prevent the migration of cobbles beneath the log structure. This migration of cobbles is to be avoided at all costs since it eliminates the effectiveness of the structure.
8. Place large rocks on the filter cloth against the main log to keep the filter cloth and log in place. Smaller material (cobbles) is to be placed on the upstream of the rocks to provide a smooth upstream bed surface and fill in the voids.
9. An alternative is to place short (0.75 m) pieces of 2" x 10" planking extending from the weir crest upstream and down into the channel bed to form a barrier to movement of material similar to the filter cloth described above. It is recommended to also add the filter cloth as well. The space under the planking is filled with rock and cobbles to eliminate any voids.
10. The top of the log sill is not to be more than 0.6 m above the streambed, unless a deeper upstream pool is needed. A notch is to be cut in the middle of the weir crest to concentrate very low discharges. The notch is to be less than 1/2 the top log depth and about 0.4 m wide measured at the top of the log (see drawing).

OVERPOUR STRUCTURES – TYPICAL LOG K DAM (Small Watercourses, Width <5 m)



canadian energy pipeline association / association canadienne de pipelines d'énergie



Fourth Edition

November 2012

DWG. NO. 39

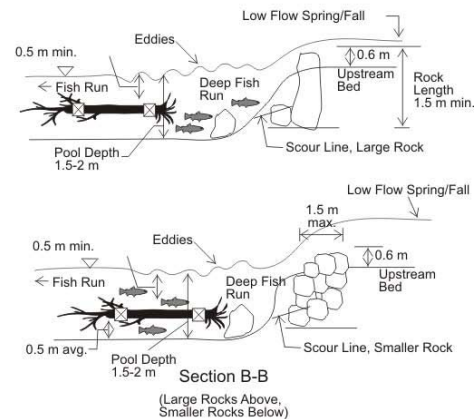
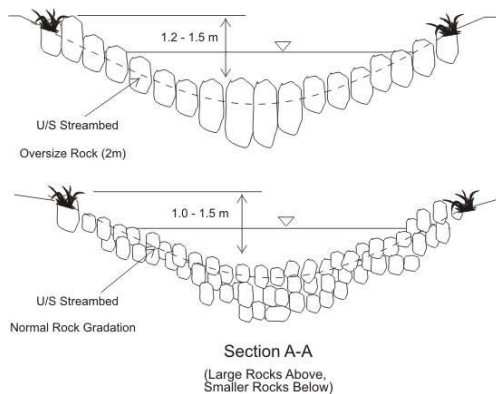
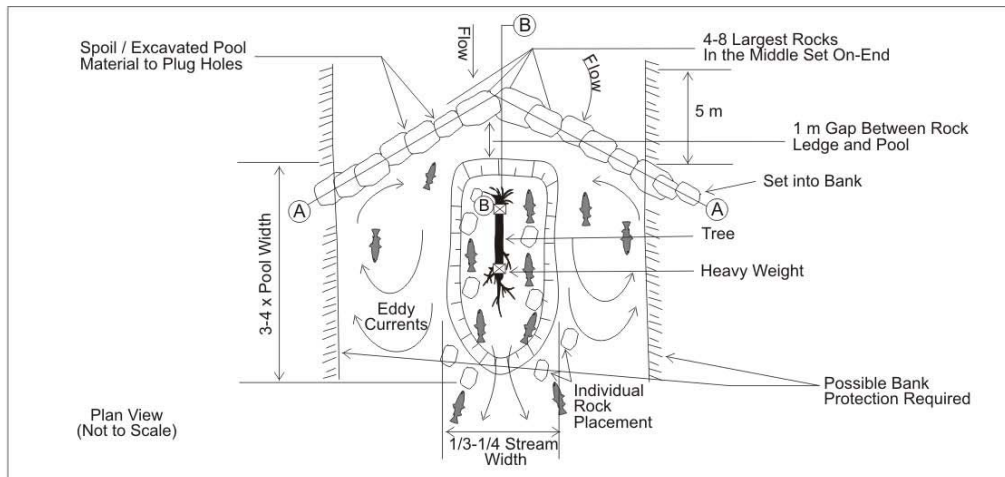

Notes:

1. Navigable Waters approval may be required prior to the installation of a Single Crest V Weir.
2. Proper placement and design are critical, and qualified specialists should be involved.
3. All weir crest rocks must slope down from the banks to the upstream point of the weir to confine the main flow to the middle 1/3 of the watercourse.
4. All rock must extend upstream from the bank where they are to be buried deeply to the middle point of the weir.
5. The largest (4-8) rocks must be placed at the point of the weir and set in place with the longest side pointing down (as shown) in a trench already excavated for this purpose. All rock is to be jammed together by machinery to provide tight-as-practical fit. Additional stabilizing rocks and spoil are to be placed around these rocks. Then the remainder of the weir crest may be built. The weir crest width should be 1.5 m wide.
6. The upstream notch on the weir must be within the middle third of the watercourse, but may be placed at any point within to move the current from side to side. Bank armouring may be necessary in such cases where the potential for bank erosion exists.
7. The top of the rocks in the notch of the weir is not to be more than 0.6 m above the streambed, unless an upstream pool is required. The bank tie-in location is to be 1.5 m above the watercourse elevation. Ensure that the rocks taper gradually from the notch to the tie-in point on the bank.
8. Only a minor amount of spoil material may be used to fill in the voids in the weir crest to prevent water from flowing through the weir. The spoil is only to ensure relative water tightness. All remaining spoil material must be placed 10 m beyond the streambanks, preferably 1.5 m above current water level.
9. All elevation differences shall relate to the low streamflow conditions in the spring or fall, or at time of inspection, whichever is less.
10. All individual placed rocks are to be a uniform size.
11. Pool depth is to be 1.5-2.0 m (maximum) due to watercourse width.

Adapted from CAPP (1993)

OVERPOUR STRUCTURES – TYPICAL V WEIR – SINGLE CREST (Small Watercourses)



canadian energy pipeline association / association canadienne de pipelines d'énergie



Fourth Edition

November 2012

DWG. NO. 40

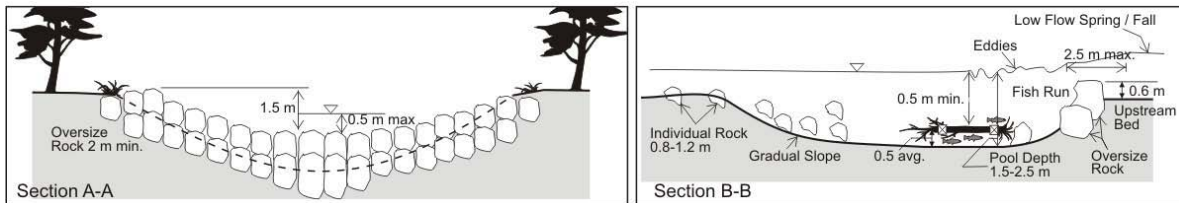
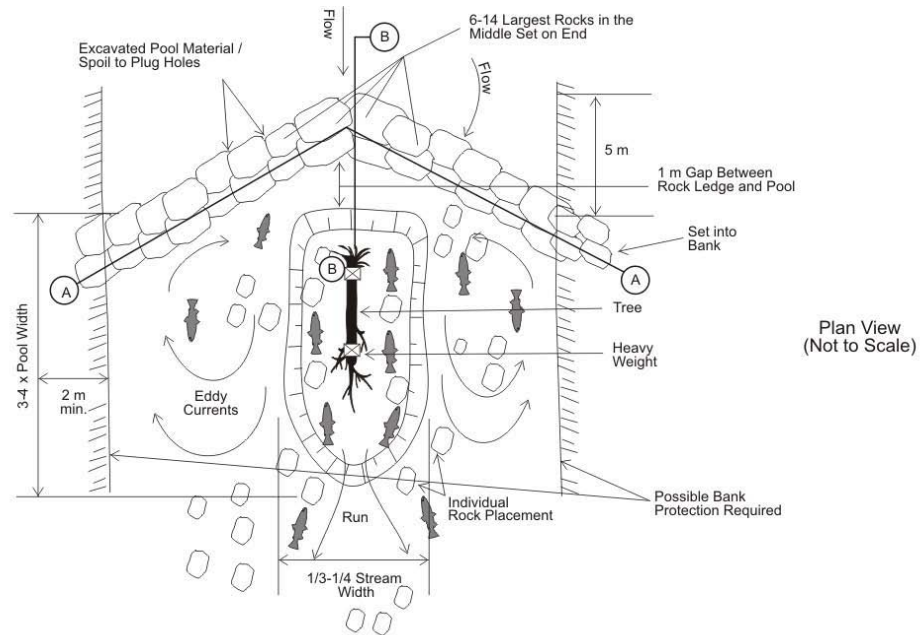

Notes:

1. Navigable Waters approval may be required prior to the installation of a Double Crest V Weir.
2. Proper placement and design are critical, and qualified specialists should be involved.
3. All weir crest rocks must slope down from the banks to the upstream point of the weir to confine the main flow to the middle 1/3 of the watercourse.
4. All rock must extend upstream from the bank where they are buried deeply to the middle point of the weir.
5. The largest (8-16) rocks must be placed at the point of the weir in a double row and set in place with the longest side pointing down (as shown) in a trench already excavated for this purpose. All rock is to be jammed together by machinery to provide a fit as tight as practical. Additional stabilizing rocks and spoil are to be placed around these rocks. Then the remainder of the weir crest may be built. The weir crest width should be 2.0 m wide.
6. The upstream notch on the weir must be within the middle third of the watercourse, but may be placed at any point within to move the current from side to side. Bank armoring may be necessary in such cases where the potential for bank erosion exists.
7. The top of the rocks in the notch of the weir is not to be more than 0.6 m above the streambed, unless an upstream pool is needed. The bank tie-in location is to be 1.5 m above the watercourse elevation. Ensure that the rocks taper gradually from the notch to the tie-in point on the bank.
8. Only a minor amount of spoil material may be used to fill in the voids in the weir crest to prevent water from flowing through the weir. The spoil is only to ensure relative water tightness. All remaining spoil material must be placed 10 m beyond the streambanks, preferably 1.5 m above current water level.
9. All elevation differences shall relate to the low streamflow conditions in the fall, or at time of inspection, whichever is less.
10. All individual placed rocks are to be a uniform size.
11. Pool depth is to be 1.5-2.5 m (maximum) due to watercourse width.

Adapted from CAPP (1993)

OVERPOUR STRUCTURES – TYPICAL V WEIR – DOUBLE CREST (Large Watercourses)



canadian energy pipeline association / association canadienne de pipelines d'énergie



Fourth Edition

November 2012

DWG. NO. 41

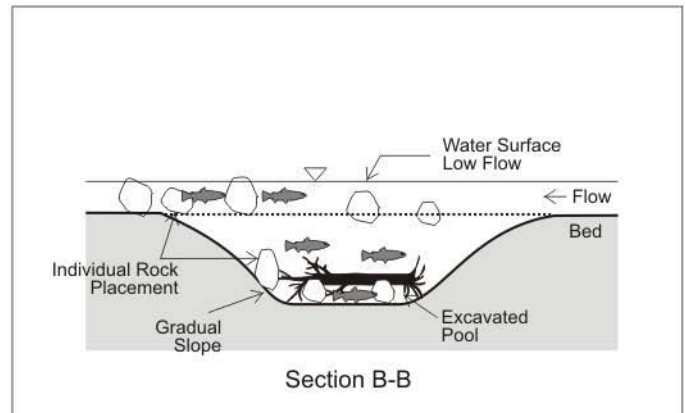
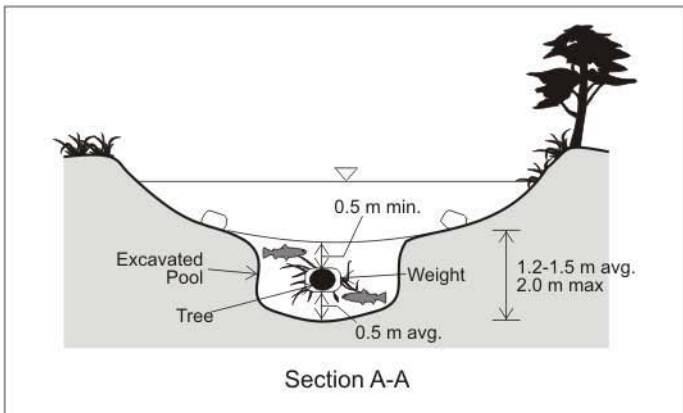
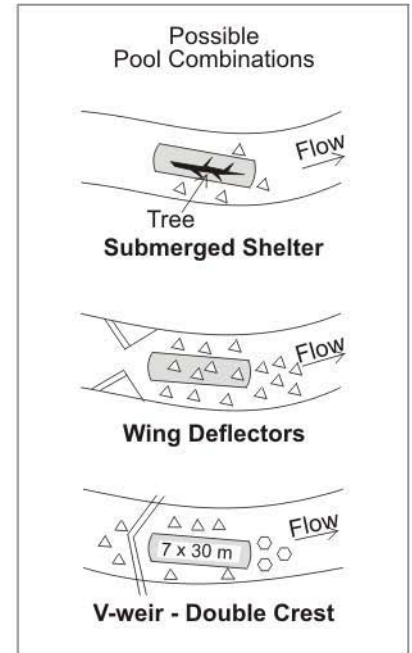
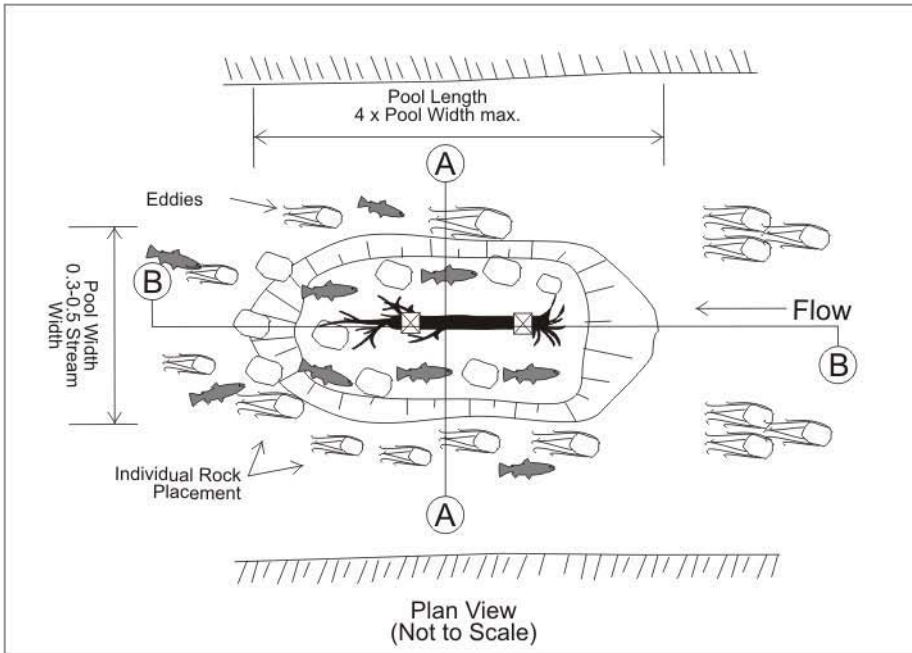

Notes:

1. Navigable Waters approval may be required prior to the installation of a typical resting pool.
2. Proper placement and design are critical, and qualified specialists should be involved.
3. Locate the pool in a relatively straight section of the watercourse. Moderate existing depth is best indicator.
4. Centre the pool in the deepest part of the channel.
5. Pool width is not to exceed 2/3 of the channel width.
6. Pool depth must be a minimum of 1.5 m, but not to exceed 2.5 m.
7. Pool length is not to exceed four pool widths; normally about three times pool width is recommended.
8. Typical pool dimensions range from 2 m x 4 m on a small watercourse to 10 m x 40 m for a large watercourse. Excavations normally produce a water depth of 2 m or greater during low flow conditions in most watercourses, and greater than 2 m in large watercourses.
9. All spoil material is to be placed 10 m outside the channel limits at the time of construction (low flow) preferably in an abandoned dry side channel, a minimum of 1.5 m above current water level. This will avoid the material being washed back into the pool with the first high water.
10. Individual rocks 0.8-1.2 m in diameter may be placed at or below but no greater than 0.3 m above current water level at the time of work.

Adapted from CAPP (1993)

SUBSTRATE MANIPULATION – TYPICAL RESTING POOL



canadian energy pipeline association / association canadienne de pipelines d'énergie



Fourth Edition

November 2012

DWG. NO. 42

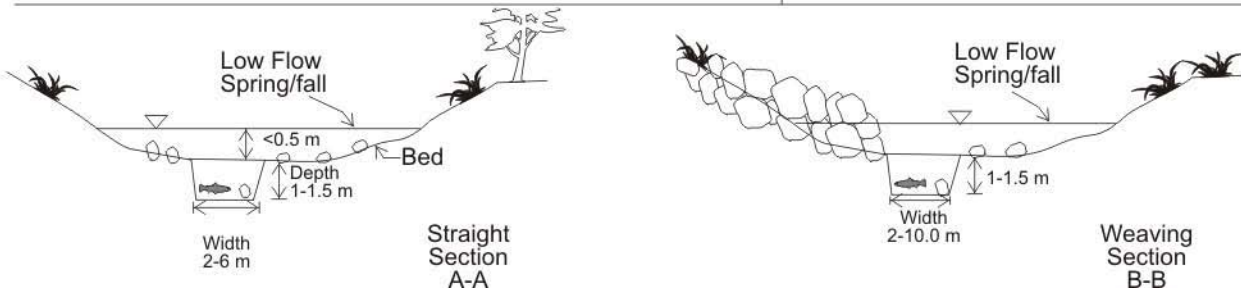
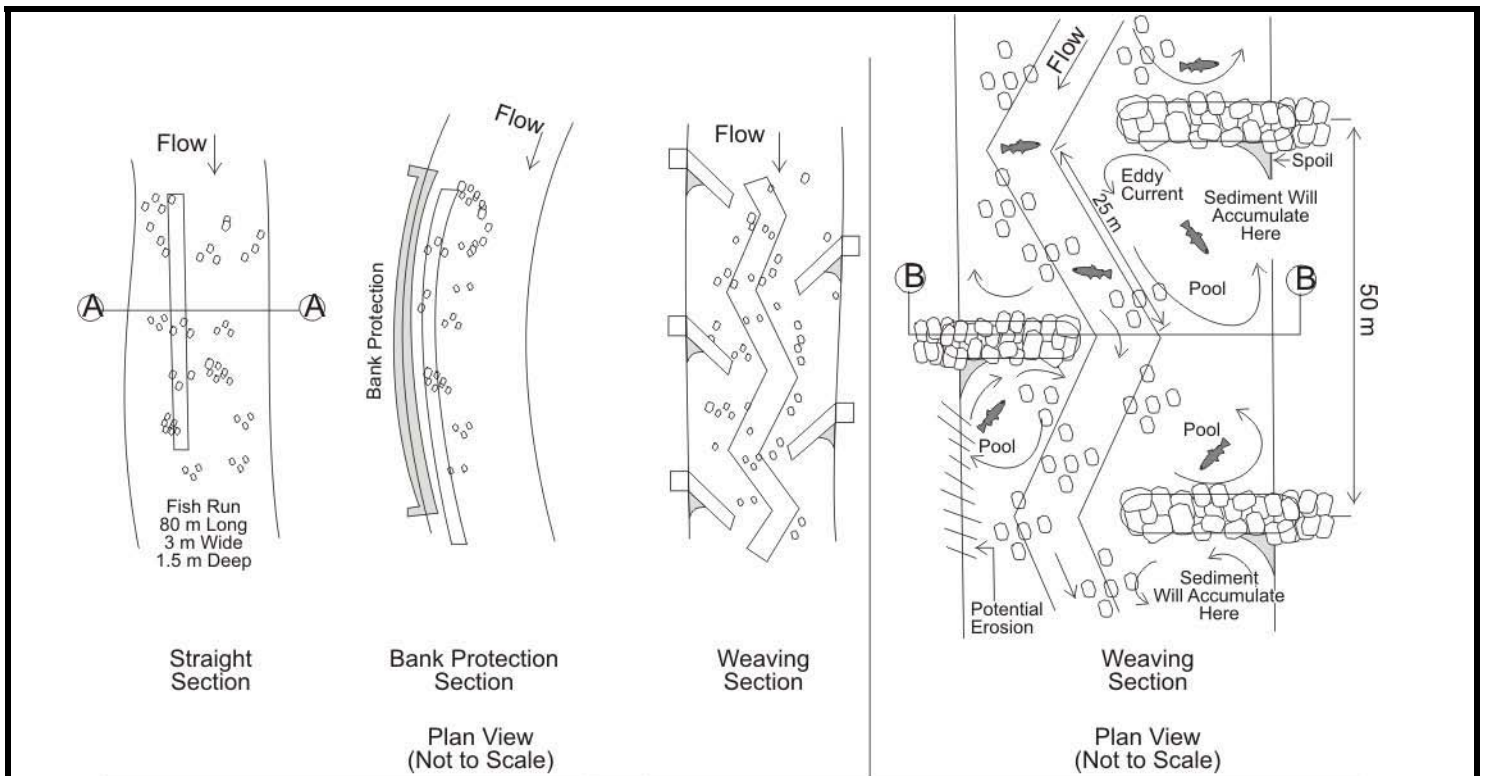

Notes:

1. Navigable Waters approval may be required prior to the installation of an excavated fish run.
2. Proper placement and design are critical, and qualified specialists should be involved.
3. Excavated run is to be located within the middle 1/2 of the watercourse, crossing the deepest section, or as directed in the field.
4. The excavated run is to be composed of several straight sections, placed at angles to each other to provide a deep meandering channel in an otherwise straight, wide and shallow reach.
5. Individual rocks or rock clusters may be placed within the excavated run (width permitting) or along the outside to deflect the main current into the excavated run and maintain higher velocities to reduce sediment deposition within the trench.
6. With this structure, care of spoil is important since improperly disposed of material could easily be swept back into the excavated run. Spoil material is to be removed 10 m from the channel, 1.5 m above current water level.
7. Excavated run structures may be accompanied by rock clusters, deflectors and overhang structures to provide high quality habitat.

Adapted from CAPP (1993)

SUBSTRATE MANIPULATION – TYPICAL EXCAVATED FISH RUN



canadian energy pipeline association / association canadienne de pipelines d'énergie



Fourth Edition

November 2012

DWG. NO. 43

Appendix B Watercourse Crossing Case History Summaries

The following summarizes 326 case histories of open cut, dam and pump, flume, temporary diversion and two-stage coffer dam watercourse crossings that have been taken from TERA Environmental Consultants (1996) with the exception of directional drilling, which was taken from P.A. Harder and Associates Ltd. (1995).

Open Cut Case History Summary

Fifty-nine examples of open cut crossings are summarized. These examples discuss water crossing construction at various sized watercourses using the plow, hoe, clamshell dragline, yo-yo dragline and dredge techniques.

All small watercourses (<10 m wide) were excavated by hoes with the exception of one which was plowed-in. Construction of all small watercourses were completed in less than one day with the exception of the plowed-in crossing, which required an extra day for bank preparation. Sedimentation and water quality were monitored at several crossings. No detectable changes in water chemistry or composition of streambed materials were recorded when the plow method was used. A dramatic increase in suspended sediments and increased benthic drift were reported during an open cut crossing with hoe excavation. However, it was concluded that the negative impacts to the benthic community were limited to the period immediately following construction and no negative impacts on the benthic community were detected after peak spring flow.

All medium-sized watercourses (10-20 m in width) were excavated with hoes, although draglines were used to assist at three crossings. Most crossings of this size were completed in two days. However, four days were required where trucking of spoil was conducted and three additional days were needed when blasting was required.

A high suspended sediment load was common in those crossings which were monitored for TSS or turbidity as well as those with anecdotal observations. One crossing with very coarse sediments had a 'very large percentage' of sediment deposited within the first 200 m, while another in coarse sediments indicated that construction did not result in a significant sediment load. Other observations indicated that after 24 hours very little or no sediments remained in suspension and that, in general, most impacts seemed to be very short-lived and substrate composition returned to preconstruction conditions within nine months. Only two references to biotic impact are referenced in the case histories for open cut trenching. One monitoring program found that after one month there had been no significant increase in mountain whitefish egg mortality downstream of the crossing and juvenile whitefish continued to use pool habitats. It was also noted that although the high level of suspended solids was injurious to some fish, the relatively short-term nature of the disturbance minimized effects on downstream fish. Another anecdotal comment points out that extra time spent trucking spoil offsite resulted in increased instream activity that likely caused more disturbance than would have occurred with instream spoil storage.

Large watercourses, over 20 m in width, are constructed with a variety of methods. Of 22 open cut trenching examples in watercourses ranging from 20 m to 1000 m in width, hoes were generally used to excavate the trench. However, clamshell draglines, yo-yo draglines and dredges were also commonly used. The length of instream activity ranged from 1 day for 40 to 60 m wide crossings, to 60 days working 24 hrs/day for an 885 m wide crossing. Most watercourses less than 50 m in width took 1-3 days. Those crossings that took longer than one week tended to have adverse conditions such as extreme width (885 m) and very sandy substrates (60 days); very steep and long approach slopes (6 weeks); or a deep channel requiring construction of pads for hoes (2.5 weeks).

The comments related to impacts on biotic resources and water quality at larger water crossings were similar to those of smaller watercourses.

In general, open cut crossings are always successful although they range in difficulty and the degree of success. No examples of abandoned attempts of open cut crossings were encountered. Those crossings which were well constructed and successful were well planned, had sufficient equipment onsite, had experienced crews and were completed in as little time as practical. Crossings tended to have low success where: the floodplain or staging area was too wet or too small, the substrates were too soft or sandy, the contractor was disorganized and had no plan, there was an inappropriate use of instream sediment control devices; poor advice from inspectors and government representatives undersized equipment; or flood conditions.

Dam and Pump Case History Summary

Thirty examples of the dam and pump water crossing method were considered in the case history summary.

The dam and pump method was most commonly used on watercourses that were less than 10 m in width although examples of watercourses 15, 30 and 75 m in width are also summarized. In most cases, dams were constructed with conventional sandbags, although the larger 1 m³ sandbags have been used in many of the higher energy watercourse crossings in British Columbia. One example of an aquadam is cited. Pea gravel bags used in conjunction with an impermeable liner have been used in several U.S. crossings. One company in southern Ontario as well as contractors in Alberta made many of their dams from plate steel pressed into the bed and banks, effectively sealing the streamflow. Other examples include gravel and rock dams, with and without impervious materials. In some situations, the channel morphology and substrate composition allowed pumps to be placed in upstream pools without the need for dam construction. In one situation, a partial pump around with no dams was used to minimize flow over the ditch area during an open cut crossing.

The degree of success experienced at many crossings was determined by the ability to seal the watercourse or work in dry conditions. Plate steel dams worked very well when conditions were appropriate. Where no dams were constructed and the watercourses were pumped dry above the crossing and discharged below, excellent results were obtained. Conventional sandbags and 1 m³ sandbag dams seemed to have worked well although seepage became a problem if not constructed properly.

Inadequate pump capacity can be problematic with the dam and pump crossing technique. There were several examples of insufficient capability, pumps breaking down, and pumps running out of fuel. All three situations can be prevented with better pre-planning. Where subsurface flow is a concern, additional pumping from the trench area is required and two upstream dams may be warranted. Common pump sizes include 3", 4", 6", 10" and 12" pumps. In one instance, the limiting factor was the number of pumps which could fit in the pool upstream of the dam.

Pump discharge locations vary depending upon water quality and the standards for water quality. Bypass water, although usually pumped directly back into the watercourse, was discharged on to the ice downstream of the crossing in one situation. Silty trench water was usually pumped on to shore, either into surrounding vegetation or with sumps, settling ponds or silt fence lined areas. In certain situations, water was discharged into silt bags.

Instream activity at most water crossings where the dam and pump method was used required one day or less. Some took one day to set up and one day to construct the crossings. Other examples required 2.5, 3 and 5 days. In the case of the latter, the job was considered to have been poorly conducted by the government inspector with inadequate dams and pumps as well as a poor choice of discharge location.

Apart from environmental protection measures relating to the pump discharge areas and bank reclamation, special measures included a full contingency plan in case the crossing was not successful, fish salvage from the isolated areas and secondary upstream dams to trap seepage which in turn was pumped out. Silt curtain or filter fabric/hay bales were installed downstream of the flume with limited success at some crossings.

The total suspended sediment targets were not exceeded during construction of one crossing where monitoring was conducted and results are available.

In general, dam and pump crossings appear to be successful. Those crossings where difficulties were encountered, were the result of poor planning. In particular it is important to: construct high quality impermeable dams; calculate streamflows and have on hand enough pumps for at least 150% of the anticipated flow; have spare generators, fuel and pumps onsite; and finally, a contingency plan in case unforeseen problems arise. One environmental inspector that had

been involved at numerous crossings where the sump and pump [high volume pump] method (*i.e.*, no dams constructed) had been used successfully, believed the term dam and pump was archaic. He felt that the term led many contractors or government representatives to install dams when their use was not warranted.

Flume Case History Summary

Twenty-eight examples of the flume water crossing method were considered in the case history summary.

The flume method was most commonly used on watercourses less than 10 m in width although examples of 30 m, 100 m and two channels of 200 m are included in the case histories. In most cases the flumes were preconstructed large diameter pipes welded to a flange plate. Many of the crossings had multiple pipes, the largest being 4 x 42" and 1 x 48" flumes welded side by side with a single flanged plate on the upstream side. At many crossings where the flume method was used, supplemental pumping was required to handle the flows. In one case the flume method was used in a partial temporary diversion. A channel on one side of an island was flumed and then the other.

Most flumes were sealed by conventional sandbags with an impermeable liner, although dams constructed of 1 m³ sandbags filled with sand or gravel, dirt, land fill and clay were also used. In one case aquadams were used to dam and direct flow toward the flume while at another crossing, median barriers served to direct a portion of the streamflow into an old stream channel, thereby reducing the flow through the flume.

Most flume crossings require some degree of pumping to minimize or remove the water in the isolated area. In a number cases, several pumps were required to handle the groundwater flow despite a good seal on the dams.

There were several examples of the flumes being installed prior to the crossing construction to allow vehicle access or to avoid instream timing restrictions.

Instream activity at flumed water crossings ranged from four hours for a 2 m wide drainage to eight days for a large river. However, most smaller crossings were completed in three days or less.

Apart from the environmental protection measures relating to pump discharge, fish salvage between the dams and bank reclamation, no special measures were usually employed. Silt curtain or filter fabric/hay bale dams were installed downstream of the flume at some crossings.

Water quality and sedimentation monitoring was conducted at several crossings where the flume method was used with limited success. In one case the short-term total suspended targets were met but the 48 hour targets were surpassed. This crossing was also the largest flume project, encountered problems with unfiltered discharge water re-entering the watercourse and required eight days of instream activity.

The success rate of the flumed crossings indicates that it may not be the best choice for an isolated technique unless conditions are ideal. Problems that created poor, difficult or disastrous crossings included: poor planning; lack of experience; a sinuous stream channel; an unstable ditch and flume which was too short to allow for a wide ditch; poor seals on dams; undersized equipment; organic banks and substrates; insufficient pump discharge area or sump; high groundwater seepage; improperly installed sandbag dams; difficulty threading pipe bends under the flume; steep approach slopes that prevented threading pipe under flume; insufficient flume capacity; pump failure; and leaking hoses.

In general, the degree of success at watercourses crossed using the flume method seems to be less than other crossing techniques. As one construction superintendent confessed, "he has done about a dozen, was only proud of one..."

Temporary Diversion Case History Summary

Seven examples of watercourses crossed using the temporary diversion method were considered in the case history summary. All but two of the examples were on large rivers where alternative techniques to limit sedimentation of downstream areas were limited. Two of the examples required excavation of new channels in old high water or abandoned channels, one had an entirely new channel excavated between meanders in a silty floodplain, and the other four were diversions around islands and gravel bars using existing active channels.

Of those crossings which required excavation of a new channel, one was a last minute decision with no planning and no erosion protection of the new channel. The other two were well planned and had sufficient geotextile and riprap onsite to prevent erosion of the new channel. Those crossings that used existing channels only had erosional concerns as a result of increased water velocity and depth. One example indicated that gravel displacement from a change in flow patterns was noted 900 m downstream of the diversion. At one crossing, flumes were installed to allow flow in the new channel to cross over the previously excavated trench. Flumes were also installed at one crossing as a contingency in the new channel.

The diversion techniques ranged from damming the old channel with soil from the hard plug on the upstream end of the new channel, to imported sandbags and liner, aquadams and median barriers, as well as instream cobbles and material from the gravel bars. Aquadams were used on three of the seven projects although they required reinforcing with median barriers on one large diversion where the aquadams kept washing away. In one instance, a second dam was installed immediately downstream of a sandbag and liner headwall dam to collect seepage which was subsequently flumed over the excavation.

The isolated area was pumped into abandoned channels in two cases although, in one of the instances, large volumes of discharge water resulted in water flowing out of the abandoned channel into the watercourse. Silt fences were erected in the old channel to filter the sediment.

The periods of instream construction when the temporary diversion method was used varied according to the size of the watercourse. The two smallest crossings resulted in two and four days of instream activity. Instream periods of 5 and 17 days were reported for the other two crossings where an instream period was indicated.

Of the three crossings where sedimentation and water quality observations were provided, results indicated that: water quality objectives were met; turbidity was not noticeable while constructing the dams; and only a minimal increase in silt load occurred due to heavy silt load already present in the river. On one crossing it was observed that sedimentation increased after diverting streamflow into an unlined new channel.

Special environmental measures undertaken include: special protection for banks and spoil piles to accommodate increased flow after the diversion into one channel; fish salvage from the isolated channel; and in one instance retaining eagle watchers to let the blasting crew know when eagles had left the area so blasting could proceed.

Generally the temporary diversions, if planned and implemented appropriately, were considered successful. The one crossing where difficulty was encountered was the result of a sudden change in methodology from the open cut trenching method to temporary diversion. Therefore, thorough planning of the procedure and appropriate protection measures were not in place. Difficulties that arose during construction of the crossings considered to be successful were problems associated with the efficient diversion of water; the erosion of the new channels; and the correct placement of spoil so as to avoid susceptibility to erosion caused by increased volumes.

Two-Stage Cofferdam Case History Study

Five examples of two-stage coffer dams are summarized, although one reference is a generic reference to approximately 40 coffer dam crossings which were undertaken over a several year period and another is similar to five other crossings undertaken by the same construction superintendent.

All examples were constructed within large rivers between 25 m and 100 m in width, with substrates of coarse textured materials. Dams were constructed from various materials including clean pitrun, 1 m³ sandbags, washed gravel with plastic liner and conventional sandbags. At one crossing where 1 m³ sandbags were installed, an upstream deflection dam was also constructed to reduce the water velocity in the vicinity of the dam construction. Seepage and infiltration of water into the coffered area posed a problem in all cases. This was generally handled by installing numerous pumps. In one case, a sheet piling dam was installed inside the coffer and sealed with sand. Unfortunately, trench sloughing caused the sheet piling to fall into the trench and cables were installed to hold the sheet piling back. Riprap was installed at one watercourse on the upstream face of

the coffer to prevent erosion. Dewatering was either onto the banks or into settling ponds within the coffer. In one example, where silty water from inside the dam was percolating out into the river, a deflection dam was constructed to increase the water pressure on the downstream face of the dam. This prevented any outflow of turbid water by allowing water to infiltrate the coffer. The water was then pumped into a discharge area on the bank.

Instream activity ranged from one week to 72 days. The instream period of 72 days appears to be the exception due to problems encountered during excavation. The other two crossings completed took two and three weeks. One crossing was aborted and open cut in a week after flooding and dam failure endangered the crews.

Special environmental measures employed included downstream silt monitoring, and the installation of sorbent booms in the event of an accidental spill.

Downstream siltation in most cases seems to have been reduced by installation of the coffer although the increased instream period produces a longer duration of silt loading.

In general, coffer dams seem to work well as long as they are well planned and installed by an experienced crew. The engineering manager of the company which had completed 40 coffer dam crossings indicated that once the crew was experienced, construction was very successful. One superintendent also indicated great success once the system had been worked out but also indicated it was very costly and did increase the instream period. The expense was confirmed by one quote of \$300,000 for a 100 m crossing. Many of those interviewed during the case history review indicated that they did not have any experience with this crossing method and noted strong reservations related to the mid stream tie-in due to safety and constructability. Two respondents indicated that they would only consider this technique in the event that instream repairs were required.

Horizontal Directional Drilling

Directional drilling can be an effective method for installing pipelines beneath watercourses with relatively low environmental impact to streambanks and water quality. Potential impacts associated with directionally drilled installations include land clearing affecting visual and wildlife values, possible loss of drill mud and the effect on water quality during construction as well as disposal of used drilling mud. The feasibility of using directional drilling techniques is strongly limited by site conditions, including soil characteristics, and available workspace and geometric constraints. The case history review indicated that drill mud seepage can occur for all soil types and is most likely when highly permeable zones are present with minimal cover between the drill path and the bed of the watercourse. There was a higher incidence of drill mud seepage for sites characterized by larger grain sized materials (gravels, cobbles and boulders) than for sites characterized by fine-grained and consolidated materials. The incidence of significant technical difficulty (*i.e.*, loss of equipment, collapsed bore holes and

damaged pipes) was higher for sites characterized by the presence of large gravels, cobbles and/or boulders. The feasibility of directionally drilled pipe installations generally decreases for larger diameter pipes and is further compounded when suboptimal soil characteristics are present. There were relatively few large diameter pipe installations in all regions examined in this study.

The significance of potential drill mud seepage into the watercourse is typically limited to point sources along the drill path. In some instances there is the opportunity to reduce or arrest seepage by decreasing the pressure of the drill mud. Depending on where these point sources occur, it may also be possible to implement mitigative measures such as containment berms and vacuum trucks to control water contamination. These measures can be effective for mud seepage occurring along the approach slopes and in some cases, shallow near-shore areas. Significant leakage of drilling mud can also occur at the drill entry or exit point due to different pressure heads if there is a large change in elevation between the two points as well as during reaming or pull-back.

Drill mud seepage was reported for 36 of the 146 cases reviewed. The reported incidence of drill mud seepage was 8% for Alberta and Saskatchewan and 20% for the continental U.S. The incidence of drill mud seepage was 43% for the 37 case histories reviewed in British Columbia. Drill mud seepage occurred at all five crossings reviewed for Ontario and Québec. Drill mud seepage occurred in all soil types including fine- and coarse-grained unconsolidated materials and hard rock. The incidence of drill mud seepage was less than 14% for both the small and medium diameter pipe size categories. Drill mud seepage was reported for 85% of the large diameter pipe installations.

There are a number of site-specific engineering and geological constraints that may preclude the use of drilling as a viable crossing alternative. These include available workspace, pipeline specifications (length and diameter), site geometrics and soil conditions. The technology is particularly well suited for sites with fine-grained soil characteristics (sands, silts and clay and consolidated soil types such as rock and sandstone. Unconsolidated materials with large gravels, cobbles and boulders are extremely difficult to drill and are one of the main limitations to directional drill applications. Potential problems with these materials include deflection of the drill bit, drill bit damage and equipment losses, removing boulders/cobbles from the bore, possible collapse of the bore hole and pipe damage during the pull-back operation. The potential for these problems generally increases with the size of the bore. Although directional drilled installations have been completed through mixtures of gravel, cobble and/or boulders, the installation failure rate and incidence of serious technical difficulties is high. This was particularly true for sites where large cobble and boulders were present. The number of successful installations through these conditions was relatively low. These potential problems are further compounded for installations of large diameter pipes and increased crossing width. The small number of installations involving large diameter pipe identified in this review, coupled with the relatively high incidence of technical difficulty experienced further supports this conclusion.

Significant technical difficulties were reported for 8 of the 37 case histories reviewed for British Columbia. These difficulties included loss of the borehole, pipe damage during the pull-back operation, equipment losses through jamming or breakage, and inaccurate steering control. Three of these incidents required a second bore hole to be drilled before the crossing could be completed. Soil conditions were gravels and cobbles at two of these crossings and shale/rock at the third crossing site. Two other drilled crossings were unsuccessful and were abandoned in favour of alternative crossing methods.